

**NEW! TWIN-COUPLED HI-FI AMPLIFIER**

NOVEMBER 1957

# Radio-Electronics

TELEVISION • SERVICING • HIGH FIDELITY

HUGO GERNSBACH, Editor

Lower-Noise  
TV Booster



Servicing Transistor  
Local Oscillators



Loudspeakers  
of the Future



Transistorized and  
Hybrid Auto Radios



New Amplifying  
Devices ▶

(See page 32)

35c  
U.S. and Canada

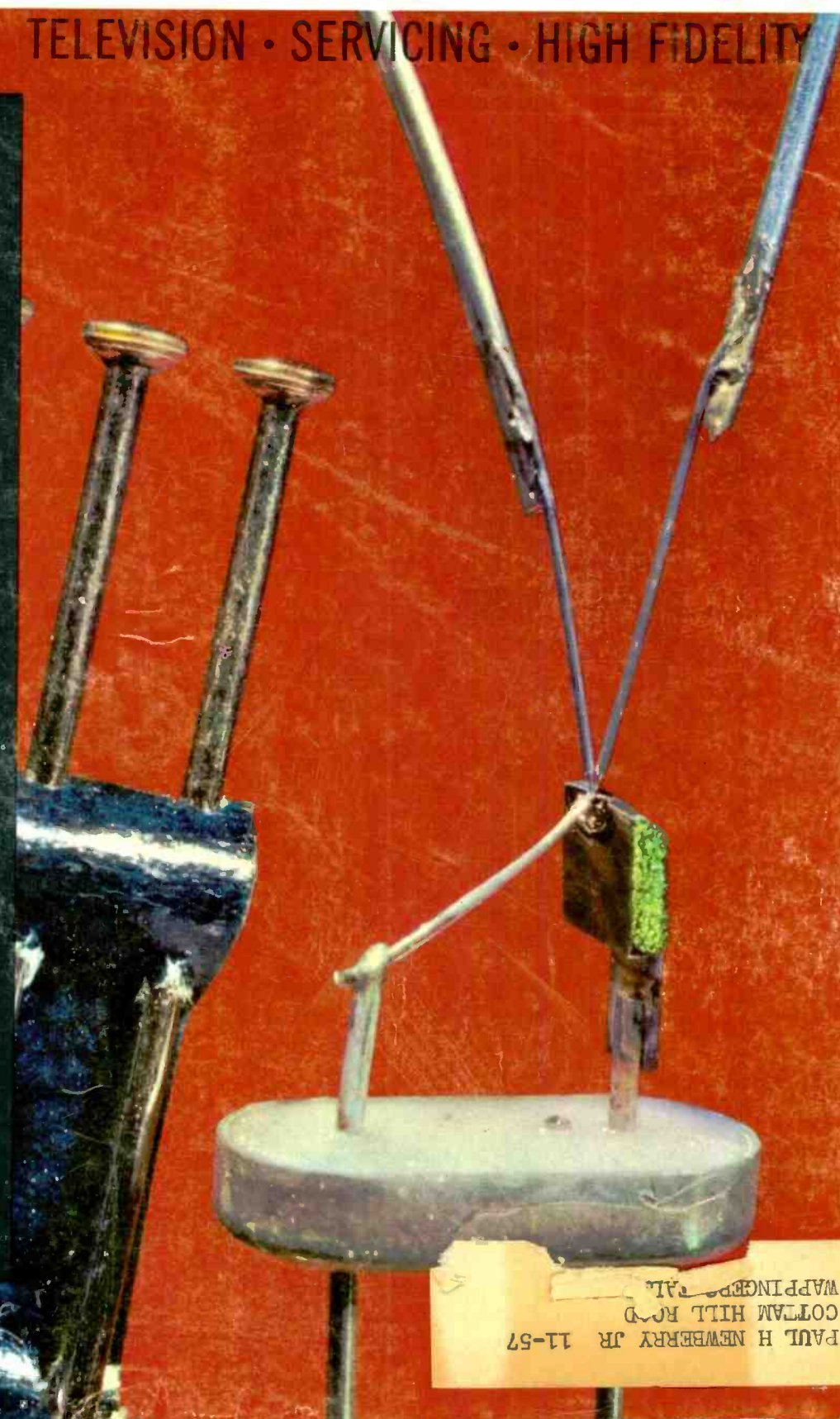

PAUL H NEWBERRY JR 11-57  
COTTAM HILL ROAD  
WAPPINGER FALLS, VA

40%

DUMONT  
POSITIVE  
QUALITY

FEWER CALLBACKS\*

A positive fact about  
Du Mont Positive Quality . . .

Du Mont Picture Tubes cut callbacks due to  
tube failure by 40%. Consider what  
this means to you — fewer callbacks,  
greater profits.

Ask your distributor about  
Du Mont Positive Quality Picture  
Tubes and Electronic Tubes.

- Send name and address for  
your free copy of the Du Mont  
Replacement Tube Chart.

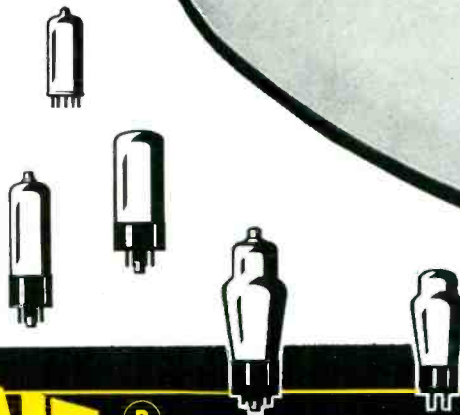

\*Based on actual  
engineering figures.

**DUMONT**®

Television Tube Division

Allen B. Du Mont Laboratories, Inc., Clifton, N. J.

# Learn to Service TV Sets—any make or model—Quickly

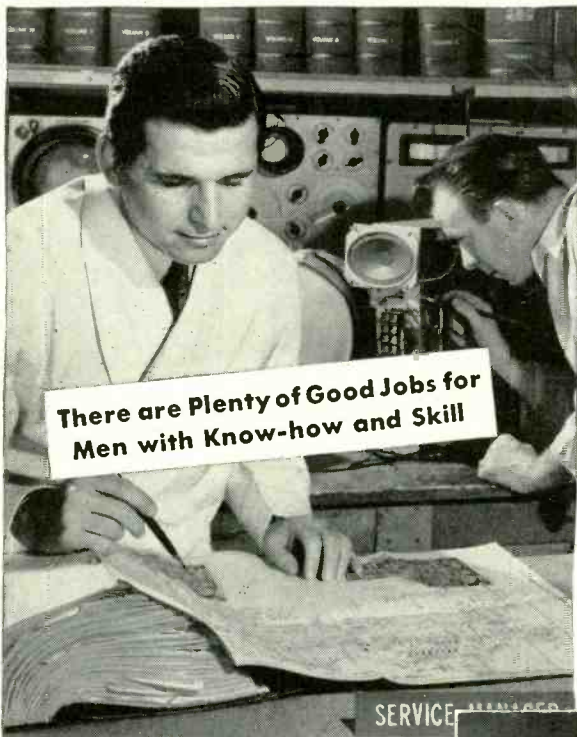

There are Plenty of Good Jobs for Men with Know-how and Skill

## NRI ALL PRACTICE Method trains you at home to become a Professional TV Serviceman

*You learn the time saving techniques, methods used by top TV Servicemen*

This is 100% learn-by-doing, practical training. NRI supplies all necessary equipment, all tubes, including a 17-inch picture tube; and comprehensive manuals covering a thoroughly planned program of practice. You learn how experts diagnose TV receiver defects quickly—audio and video—and how to fix them accurately.

You get actual experience aligning TV receivers, isolating complaints from scope patterns, eliminating interference, using germanium crystals to rectify the TV picture signal, adjusting the ion trap and hundreds of other valuable Professional techniques.

### You Get COLOR TV Books Early — Learn-by-Doing

The day you enroll, NRI sends you special Color-TV textbooks to speed your knowledge of this fast growing phase. Many full color pictures, diagrams. To cash in on Color TV you need the kind of training NRI supplies. We supply all components to build Oscilloscope, Probe, Signal Generator, TV Set, show you how to conduct experiments, practice TV repairs.

### OLDEST, LARGEST Radio-TV Home Study Training

This is professional training, not for beginners. If you have some knowledge of Radio-TV or have had some Radio Shop experience this course is for YOU. Convenient monthly terms. Mail Coupon for Catalog FREE. National Radio Institute, Dept. 7MFT, Washington 16, D. C.

**17" Picture Tube, Components and Tubes for TV Receiver, 5" Scope, Signal Generator, HF Probe—all included.**

**NRI Professional Television Training Helped These Men**



"I cannot praise NRI's TV Course highly enough. I have my own spare-time shop and all the TV work I can handle." GERALD G. STETHEM, Belpre, Ohio.



"It takes the kind of experience you offer to really learn Professional TV Servicing. You learn more and remember more." E. RAVITSKY, Northumberland, Pa.



You Learn By Doing

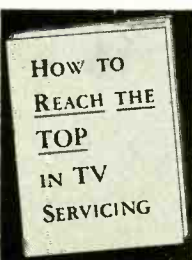

## COUPON BRINGS IMPORTANT BOOK FREE

If you want to go places in TV servicing, act quickly to find out what NRI's Professional TV Course offers. Get this book and judge for yourself how this course will further your ambition. Many of tomorrow's top TV Servicemen . . . men who can service UHF, VHF and COLOR TV . . . will be graduates of NRI. Mail the coupon.

**MAIL NOW**

**NATIONAL RADIO INSTITUTE**  
Dept. 7MFT, Washington 16, D.C.

Please send my FREE copy of "How to Reach the Top in TV Servicing." I understand no salesman will call.

Name..... Age.....

Address.....

City..... Zone..... State.....

ACCREDITED MEMBER NATIONAL HOME STUDY COUNCIL

# Radio-Electronics

Formerly RADIO-CRAFT • Incorporating SHORT WAVE CRAFT • TELEVISION NEWS • RADIO & TELEVISION\*

## EDITORIAL

- 31 Tactile Electronics—Hugo Gernsback

## ELECTRONICS

- ✓32 Two New Approaches to Amplification—Eric Leslie
- ✓35 More About Transistor Types—Paul Penfield, Jr.
- 37 Transistor Circuit Breakers—A. H. Taylor
- 38 Multiple Sun Battery—Rufus P. Turner

## AUDIO—HIGH FIDELITY

- ✓✓39 High Fidelity at Low Cost With Twin-Coupled Amplifier—Norman H. Crowhurst
- 44 Loudspeakers of the Future—Gerald Shirley
- 47 Tube Data and Amplifier Design—Herbert Ravenswood
- 49 True or False Quiz for Audiophiles—Herman Burstein
- 50 Deluxe Remote Baby Sitter—Edwin N. Kaufman
- 122 New Records—Monitor

## TELEVISION

- ✓52 Low-Noise TV Booster—J. R. Lange, K9ARA
- 55 TV Dx—Robert B. Cooper, Jr.
- 56 TV Service Clinic—Conducted by Robert G. Middleton
- 58 Tips from a TV Dx'er's Notebook—Robert B. Cooper, Jr.
- 60 A Tale from Cuba—L. F. Fenton
- 61 Practical Color TV Installation, Part III—Robert G. Middleton
- 79 Hot Coil—G. N. Carter
- 82 Positive Grid—Robert A. Hillskemper

## RADIO

- 84 7-Transistor Pocket Radio—Howard Granoff
- ✓98 Transistor and Hybrid Auto Radios, Part I—Jack Darr
- 103 Servicing Transistor Radios—James A. McRoberts

## TEST INSTRUMENTS

- 110 Time-Base Marker Generator—James G. Arnold
  - 114 Two-Transistor Signal Generator—Joseph Chernoff
  - 118 Phase-Shift Comparator Measures Frequency Ratios, Modulation—J. E. Pugh, Jr.
- |                                  |                               |
|----------------------------------|-------------------------------|
| 158 Books                        | 153 Patents                   |
| 150 Business and People          | 141 Radio-Electronic Circuits |
| 160 Corrections                  | 155 Technical Literature      |
| 16 Correspondence                | 134 Technicians' News         |
| 127 New Devices                  | 147 Technotes                 |
| 6 News Briefs                    | 144 Try This One              |
| 137 New Tubes and Semiconductors | 157 35 Years Ago              |

### ON THE COVER

(Story on page 32)

The unusual-looking device is a Spacistor, a new type of semiconductor, expected to operate at frequencies higher than 1,000 mc. The package of pins at the left gives an idea of the unit's size.

Color original by Raytheon Manufacturing Company.

- Hugo Gernsback .....Editor and Publisher
- M. Harvey Gernsback .....Editorial Director
- Fred Shunaman .....Managing Editor
- Robert F. Scott .....W2PWG, Technical Editor
- Larry Steckler .....Assistant Editor
- I. Queen .....Editorial Associate
- Robert G. Middleton .....Television Consultant
- Elizabeth Stalcup .....Production Manager
- Cathy Coccozza .....Advertising Production
- Wm. Lyon McLaughlin .....Tech. Illustration Director
- Sol Ehrlich .....Art Director
- Fred Neinast .....Staff Artist
- Lee Robinson .....General Manager
- John J. Lamson .....Sales Manager
- G. Aliquo .....Circulation Manager
- Adam J. Smith .....Director, Newsstand Sales
- Robert Fallath .....Promotion Manager



Average Paid Circulation Over 195,000

Associate Member Institute of High Fidelity Mfrs., Inc.

**RADIO-ELECTRONICS**, November, 1957, Vol. XXVIII, No. 11, Published monthly at Mt. Morris, Ill., by Gernsback Publications, Inc. Second-class mail privileges authorized at Mt. Morris, Ill. Copyright 1957 by Gernsback Publications, Inc. All rights reserved under Universal, International and Pan-American Copyright Conventions. **SUBSCRIPTION RATES:** U. S., U. S. possessions and Canada, \$4.00 for one year; \$7.00 for two years; \$9.00 for three years; single copies 35c. Pan-American countries \$4.50 for one year; \$8.00 for two years; \$10.50 for three years. All other countries \$5.00 a year; \$9.00 for two years; \$12.00 for three years. **SUBSCRIPTIONS:** Address correspondence to Radio-Electronics, Subscription Dept., 404 N. Wesley Ave., Mt. Morris, Ill., or 154 West 14th St., New York 11, N. Y. When requesting a change of address, please furnish an address label from a recent issue. Allow one month for change of address. **GERNSBACK PUBLICATIONS, INC.** Executive Editorial and Advertising Offices, 154 West 14th St., New York 11, N. Y. Telephone Algonquin 5-7755. Hugo Gernsback, Chairman of the Board; M. Harvey Gernsback, President; G. Aliquo, Secretary. **BRANCH ADVERTISING OFFICES and FOREIGN AGENTS** listed on page 143. **POSTMASTER:** If undeliverable, send Form 3578 to: RADIO-ELECTRONICS, 154 West 14th St., New York 11, N. Y.

\*Trademark registered U. S. Pat. Office.

RADIO-ELECTRONICS

Get into

# TELEVISION RADIO-ELECTRONICS

Let National Schools of Los Angeles, a Practical Resident Technical School for over 50 years, train you at home by Shop-Method for unlimited opportunities in All phases of TV, Electronics, Radio.

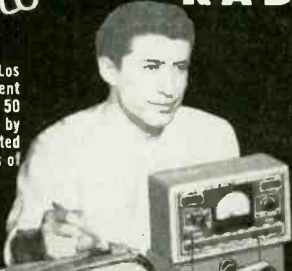

**LEARN ALL 8 PHASES BY SHOP METHOD OF THE INDUSTRY HOME TRAINING**

1. Television ... including Color TV	5. Sound Recording & Hi-Fidelity
2. Radio ... AM, FM	6. Automation
3. Industrial Electronics	7. FCC License
4. Communications	8. Radar & Micro Waves

We give you parts to build a modern TV set ... all tubes plus large screen Picture Tube ... and a Superhet Receiver. You also receive a Professional Multitester

**You get 19 Big Kits**  
... all this newest, practical equipment.

**GOOD JOBS ... MORE MONEY  
SECURITY ... ALL CAN BE YOURS!**

You are needed in the great modern Television-Electronics industry. Trained technicians are in growing demand, at excellent pay, in sales and service, manufacturing, broadcasting, telecasting, communications, research, and many other important branches of the field. National Schools Master Shop-Method Training, with newly added lessons and equipment prepares you *in your spare time*, right in your own home, for these fascinating opportunities.

**YOU EARN WHILE YOU LEARN**

Many students pay for their entire training—with spare time earning. We'll show you how you can, too! You receive material that shows you how to earn extra money servicing TV and Radio receivers, appliances, and doing many other profitable jobs.

**YOU GET EVERYTHING YOU NEED**

Clear, profusely illustrated lessons, shop-tested manuals, modern circuit diagrams, practical job projects—consultation privilege with our qualified staff.

*Don't delay your future another day.  
Send coupon for full information TODAY.*

**RESIDENT TRAINING AT LOS ANGELES**

If you wish to take your training in our Resident School at Los Angeles, the world's TV capital, start NOW in our big, modern Shops, Labs and Radio-TV Studios. Here you work with latest Electronic equipment—professionally installed—finest, most complete facilities offered by any school. Expert, friendly instructors. Personal attention. Graduate Employment Service. Help in finding home near school—and part time job while you learn. Check box in coupon for full information.

**NATIONAL SCHOOLS**  
LOS ANGELES 37, CALIF.



Approved for GI Training

CUT OUT ALONG THIS LINE



**MAIL POSTAGE—FREE COUPON ... NOW!**

1. Fill out coupon in ink.
2. Cut along dotted line and fold coupon.
3. Staple, paste, glue, or tape ends together.
4. Mail today! No postage necessary.

**FREE!** Career Book in TV-Radio-Electronics, PLUS actual SAMPLE LESSON. No obligation; no salesman will call.

Name \_\_\_\_\_ Age \_\_\_\_\_  
 Address \_\_\_\_\_  
 City \_\_\_\_\_ Zone \_\_\_\_\_ State \_\_\_\_\_  
 Check if interested ONLY in Resident Training in Los Angeles  
 VETERANS: Give date of discharge \_\_\_\_\_

CUT OUT ALONG THIS LINE

FOLD ALONG THIS LINE

Postage Will be Paid by Addressee

No Postage Stamp Necessary if Mailed in the United States

**BUSINESS REPLY CARD**  
First Class Permit No. 3087, Sec. 34.9 P.L. & R., Los Angeles, Calif.

**POSTAGE WILL BE PAID BY**  
**NATIONAL SCHOOLS**  
 4000 South Figueroa Street  
 Los Angeles 37, California

RG-117

# BEST BUILT YET

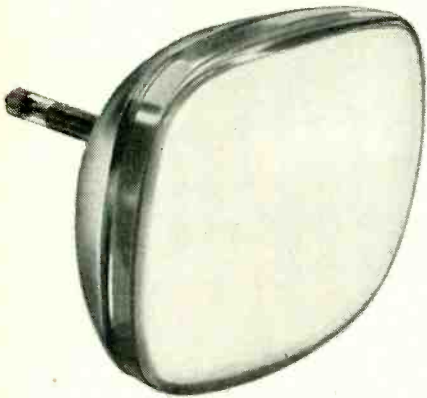

# BEST FOR EVERY SET



All Tung-Sol Tubes are engineered to one standard of quality—Blue Chip Quality. Whether they're for famous set makers or leading service dealers, Tung-Sol Tubes are identical in design and performance. Tell your supplier you'd rather have Tung-Sol!

*Blue Chip Quality*

## TUNG-SOL®

MAGIC MIRROR ALUMINIZED  
PICTURE TUBES  
RECEIVING TUBES

TUNG-SOL ELECTRIC INC., Newark 4, N. J. Sales Offices: Atlanta, Ga., Columbus, Ohio, Culver City, Calif., Dallas, Tex., Denver, Colo., Detroit, Mich., Irvington, N. J., Melrose Park, Ill., Newark, N. J., Seattle, Wash.

TUNG-SOL makes All-Glass Sealed Beam Lamps, Miniature Lamps, Signal Flashers, Picture Tubes, Radio, TV and Special Purpose Electron Tubes and Semiconductor Products.

# News Briefs

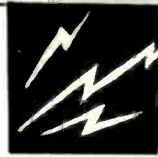

**RETMA CHANGES NAME.** The Radio-Electronics - Television Manufacturers Association has changed its name to Electronic Industries Association (EIA). This is hoped to be the end of a series of changes, by which the Radio Manufacturers Association (RMA) successively became RTMA and then RETMA before adopting its present title.

**2 TV PROGRAMS TO A CHANNEL,** making it possible for one to be used for pay-TV and the other for free viewing, has been proposed to the FCC by Blonder-Tongue Labs. Though exact technical details are not yet available, it was revealed that two pairs of signals

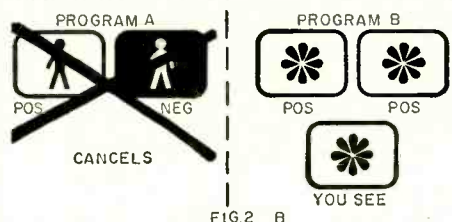
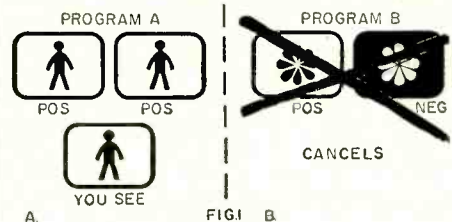

are to be transmitted by the TV station, one pair for program A and the other for program B. Program A consists of two positive units (see Fig. 1-a) which combine to produce a show on the viewer's screen. However, program B is made up of one positive and one negative signal. (see Fig. 1-b). These signals cancel each other and do not appear.

When you wish to see program B, a Bi-Tran decoding signal is fed to the receiver. The decoding signal reverses the negative image in the B program to positive and the B program is received (see Fig. 2-b). Simultaneously, one of the positive signals for the A program is reversed to negative and the A program is cancelled out (see Fig. 2-a). As applied to pay TV, the normal (free) program would come through on the A channel and the pay program on the B channel. To watch the pay program, the set would be switched to the B channel. This would bring decoding signals—carried on the regular telephone line—to the receiver,

and at the same time would transmit information as to the program selected back to the telephone office. The payment could be included in the viewer's monthly phone bill.

Modification of both receiving and transmitting equipment would, of course, be necessary.

In military uses the Bi-Tran system could allow transmission of classified information as only persons who knew the proper decoding signals could decipher the signal.

Doubling the number of TV channels would also permit educational programs and public service information as required by police and fire departments and hospitals to be transmitted without disturbing any existing programs.

### Calendar of Events

- 1957 Toronto High-Fidelity Exposition, Oct. 30-Nov. 2, Park Plaza Hotel, Toronto, Canada.
- Technical Conference of IRE Professional Group on Electron Devices, Oct. 31-Nov. 1, Shoreham Hotel, Washington, D. C.
- High Fidelity Music Show, Nov. 1-3, Hotel Mulnomah, Portland, Ore.
- International Congress and Exhibition of Measuring Instrumentation and Automation, (Interkama 1957), Nov. 2-10, Düsseldorf, Germany.
- Third IRE Aeronautical-Communications Symposium, Nov. 6-8, Hotel Utica, Utica, N. Y.
- Puerto Rico Hi-Fi show, Nov. 8-10, Normandie Hotel, San Juan, P. R.
- High-Fidelity Music Show, Nov. 8-10, New Washington Hotel, Seattle, Wash.
- Third Annual IRE Instrumentation Conference, Nov. 11-13, Biltmore Hotel, Atlanta, Ga.
- EIA (RETMA) Radio Fall Meeting, Nov. 11-13, King Edward Hotel, Toronto, Canada.
- New England Radio-Electronics Meeting, Nov. 15-16, Mechanics Hall, Boston, Mass.
- High Fidelity Music Show, Nov. 22-24, Statler Hotel, St. Louis, Mo.
- 1957 Eastern Joint Computer Conference, Dec. 9-13, Sheraton-Park Hotel, Washington, D. C.
- RETMA Conference on Maintainability of Electronic Equipment, Dec. 18-19, University of Southern California, Los Angeles, Calif.

**NEW BATTERY** makes electricity direct from gases, by feeding oxygen and hydrogen through its electrodes. The simplified diagram shows the basic operation of this new battery, called a fuel cell. Hydrogen and oxygen enter the cell through specially treated, hollow, porous carbon electrodes. When the gases diffuse to the electrodes' surfaces, they come into contact with the electrolyte, a solution of potassium hydroxide. At the hydrogen electrode, the electrochemical reaction releases an electron which flows through the external circuit and is accepted at the oxygen electrode. This flow of electrons is the current that powers electrical

(Continued on page 10)

**DEVRY TECH CAN PREPARE YOU  
IN SPARE TIME AT HOME AS AN**

# ELECTRONICS TECHNICIAN!

## No Previous Technical Experience or Advanced Education Needed!

Laborers and bookkeepers, store clerks, farmers, salesmen — men of nearly every calling — have taken the DeVry program and today have good jobs or service shops of their own in Electronics.

Here's proof positive that it can be done — done by men like yourself — men who had no previous technical experience, no advanced education.

If you are 17 to 55, we will tell you free how you may prepare for exciting, interesting jobs in Automation Electronics, Radar, Guided Missiles, Communications, Industrial Electronics and many others shown at right. Here is a chance of a lifetime to prepare to cash in on one of today's fastest growing fields. Mail the coupon for details.

DeVry Tech's amazingly practical home method enables you to spend minimum time to get maximum knowledge. In fact, you get exactly the same type of basic training equipment used in our Chicago and Toronto training laboratories — among the finest!

Send coupon for free facts NOW!

### Live-Wire Employment Service

DeVry Tech's Placement Department is in contact with some of the best-known employers in the Electronics field. The service is free to all graduates—and DeVry Tech's record in helping to place men has been outstanding.



### Draft Age?

We have valuable information for every man of draft age; so if you are subject to military service, be sure to check the coupon.

### What a DeVry Tech Diploma Meant to These Men!



G. F. Beane, W. Virginia, was a truck driver. He took the DeVry Tech Training Program, and is now a technical electronics sales representative.



Edward Hahn, Illinois. Was a laborer, now an electronics project engineer with Televiso, Inc. DeVry Tech training helped him prepare for his present position.



Nick Barton, Illinois, came directly from high school to DeVry Tech. Now has his own service shop and tells us he is "literally snowed with work."



George D. Crouch, California, was a retail store clerk. He took the DeVry Program, and today is in the servicing field for himself.

"One of North America's Foremost Electronics Training Centers"



Accredited Member of  
National Home Study Council

**DEVRY TECHNICAL INSTITUTE**

CHICAGO 41, ILLINOIS

FORMERLY

**DEFOREST'S TRAINING, INC.**

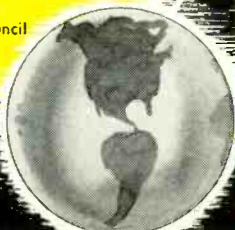

**AN  
INDEX  
to a  
BETTER JOB,  
A BRIGHTER  
FUTURE**

COMMUNICATIONS

RADAR

GUIDED  
MISSILES

TELEVISION

MICRO-WAVES

RADIO

INDUSTRIAL  
ELECTRONICS

COMPUTERS

AUTOMATION  
ELECTRONICS

**Sample Lesson  
FREE!**

See for yourself how DeVry Tech trains you for real opportunities in Electronics. We'll also give you a free copy of an interesting booklet, "Electronics and YOU."

### Mail Coupon Today!

DeVry Technical Institute  
4141 Belmont Ave., Chicago 41, Ill., Dept. RE-11-N

Please give me FREE Sample Lesson and your booklet, "Electronics and YOU," and tell me how I may prepare to enter one or more branches of Electronics as listed above.

Name \_\_\_\_\_ Age \_\_\_\_\_  
Please Print

Street \_\_\_\_\_ Apt. \_\_\_\_\_

City \_\_\_\_\_ Zone \_\_\_\_\_ State \_\_\_\_\_

Check here if subject to military training.  
DeVry Tech's Canadian Training Center is located  
at 626 Roselawn Avenue, Toronto 12, Ontario  
2004

portable . . . or permanent



# BOGEN FLEX-PAK<sup>®</sup>

MAKES EVERY PA JOB AN EASY ONE

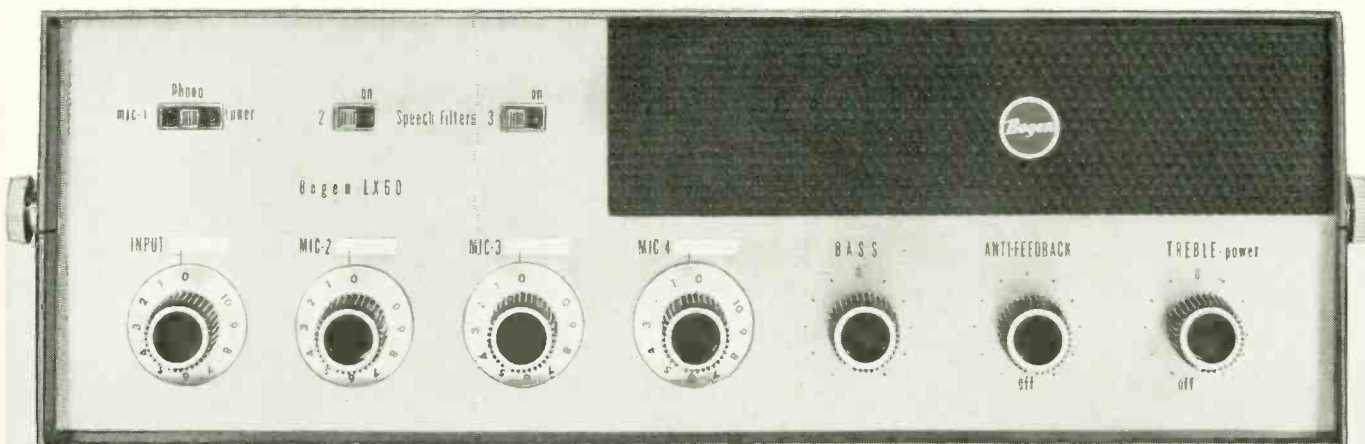

**pre-engineered to serve 90% of your sound installations**



**Deluxe LX30 30-Watt Amplifier**

4 Microphone Inputs (panel switch converts one microphone channel for phono or tuner); Built-In Remote Gain-Control Circuit; Exclusive Anti-Feedback Control; Speech Filters; Separate Bass and Treble Tone Controls.

H. 5 $\frac{3}{8}$ " W. 16 $\frac{1}{4}$ " D. 13" Wgt.: 25 lbs.



**Superb LX30 30-Watt Amplifier**

3 Microphone Inputs (panel switch converts one microphone channel for phono or tuner); Speech Filters; Separate Bass and Treble Tone Controls.

H. 5 $\frac{3}{8}$ " W. 14 $\frac{1}{4}$ " D. 13" Wgt.: 24 lbs.

BOGEN'S FLEX-PAK LINE has the flexibility you need to meet virtually every PA installation problem. Flex-Pak units are light, compact, portable, and can be used separately or grouped together. The amplifiers are available in every popular price range and power output . . . 13 models in all. That's why, with Flex-Pak, you can tailor the sound system to fit the job, with none of the fuss and bother of custom installations.

And remember—you can look to Bogen for *all* your sound equipment needs . . . speakers, microphones, turntables, tuners, and accessories. See your Bogen distributor today.

**EASY SERVICE . . . EASY INSTALLATION**

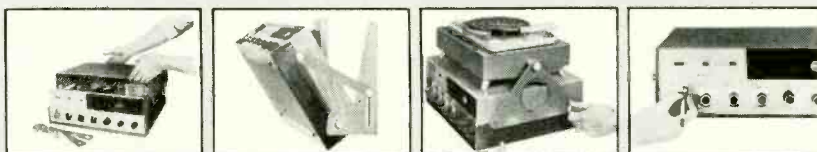

Loosen 4 thumbscrews and the lid's off for fast, easy servicing. **Folds back when not in use in easy-sliding wall-mount bracket.** **4 thumbscrews attach accessory record player mount.** **Easily erased write-in's on gain controls mark level settings.**

**Bogen** **EVERYTHING IN SOUND**  
A Division of Unitronics Corporation

David Bogen Company, Paramus, N. J., Dept. Q-11  
Gentlemen: Please send me descriptive catalog on your BOGEN FLEX-PAK Public Address Equipment and 24-page, illustrated brochure, "What You Should Know About Sound Systems."

NAME \_\_\_\_\_  
FIRM \_\_\_\_\_  
CITY \_\_\_\_\_ ZONE \_\_\_\_\_ STATE \_\_\_\_\_  
Check one  dealer  distributor  sound specialist

**MAIL COUPON TODAY**

MANUFACTURERS OF HIGH-FIDELITY COMPONENTS PUBLIC ADDRESS EQUIPMENT AND INTERCOMMUNICATION SYSTEMS



WHERE WILL YOU BE IN

# Electronics

6 MONTHS FROM TODAY?

add technical training to your practical experience

get your FCC license quickly!

then use our effective job-finding service

Get These Valuable Booklets FREE . . .



learn how

We guarantee

to train you until you receive

Your FCC license

If you fail to pass your Commercial License exam after completing our course, we guarantee to continue your training, without additional cost of any kind, until you successfully obtain your Commercial license.

### Employers Make Offers Like These To Our Trainees Every Month!

**Radio Operators & Technicians** — American Airlines has openings for radio operators and radio mechanics. Operators start at \$334.53 per month. Radio mechanic's salary up to \$1.99 per hour. Periodic increases with opportunity for advancement. Many company benefits.

**Electronic Technicians** — Convair Electronics Department: Radio and Radar Mechanics, Electronics Technicians, and Junior Engineers are wanted for a special program on fire control development and installation. Beginning rate: \$365 and up.

Here's Proof

Name and Address	License	Time
John H. Johnson, Boise City, Okla.....	1st	20 weeks
Prentice Harrison, Lewes, Del.....	1st	27 weeks
Herbert W. Clay, Phoenix, Ariz.....	2nd	22 weeks
Thomas J. Bingham, Finley, N. Dak.....	2nd	9 weeks
William F. Masterson, Key West, Fla.....	2nd	24 weeks

(Names and addresses of trainees in your area sent on request)

Accredited by the National Home Study Council

### Cleveland Institute of Radio Electronics

Desk RE-11, 4900 Euclid Ave., Cleveland 6, Ohio

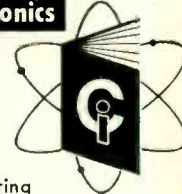

## learn how

Our Amazingly Effective Job-Finding Service Helps Cleveland Institute Trainees Get Better Jobs . . . Here are some recent examples:

**Chief Engineer**—"Since enrolling with Cleveland Institute I have received my 1st class license, served as a transmitter engineer and am now Chief Engineer of Station WAIN. I also have a Motorola 2-Way Service Station. Thanks to the Institute for making this possible."

Lewis M. Owens, Columbia, Ky.

**Airlines**—In a year and a half, he received his first class FCC License. He is continuing his training with Cleveland Institute. His goal is much higher than his present position with Eastern Airlines, so he is adding technical "know-how" to his practical experience.

Bob Thompson, Nashville 14, Tennessee

**Test Engineer**—"I am pleased to inform you that I recently secured a position as Test Engineer with Melpar, Inc. (Subsidiary of Westinghouse). A substantial salary increase was involved. My Cleveland Institute training played a major role in qualifying me for this position."

Boyd Daugherty, Falls Church, Va.

**CLEVELAND INSTITUTE OF RADIO ELECTRONICS**  
Desk RE-11      4900 Euclid Bldg.      Cleveland 6, Ohio

Please send Free Booklets prepared to help me get ahead in Electronics. I have had training or experience in Electronics as indicated below:

- |   |   |
|---|---|
| <input type="checkbox"/> Military           | <input type="checkbox"/> Broadcasting       |
| <input type="checkbox"/> Radio-TV Servicing | <input type="checkbox"/> Home Experimenting |
| <input type="checkbox"/> Manufacturing      | <input type="checkbox"/> Telephone Company  |
| <input type="checkbox"/> Amateur Radio      | <input type="checkbox"/> Other.....         |

In what kind of work are you now engaged?.....

In what branch of Electronics are you interested?.....

Name ..... Age.....

Address .....

City..... Zone..... State.....

Special Tuition Rates to Members of Armed Forces RE-11

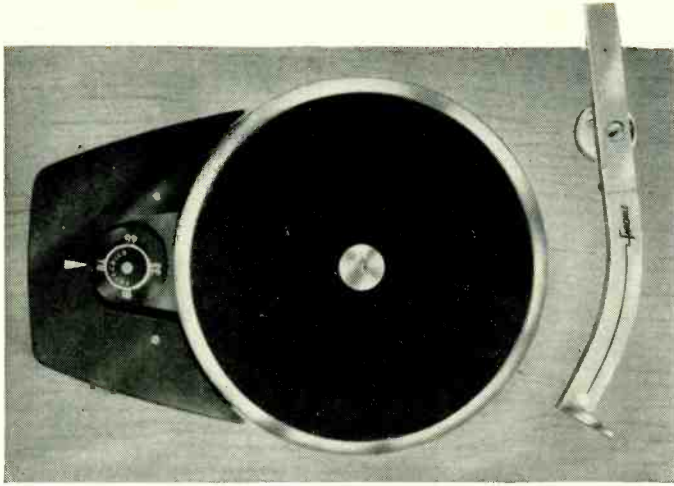

**ELECTRONICALLY OPERATED  
HIGH FIDELITY TURNTABLE SYSTEM  
ACHIEVES UNPRECEDENTED PERFORMANCE**

NEW

**FAIRCHILD** *E/D*

*electronically controlled  
and speed-regulated*

Exciting, brilliantly engineered, the new Fairchild E/D brings to the turntable — a traditionally mechanical device — all the precision and accuracy of modern electronics.

Gone are the intricate couplings — the step-pulleys, cams, rubber wheels, etc. And gone with them are the principle causes of turntable distortion.

The new Fairchild E/D achieves a quality of performance beyond anything we have ever known. Rumble, wow and flutter become academic questions. They are virtually non-existent in the E/D. Speed constancy is maintained to an incredible accuracy — precisely regulated by an electronic power source. And the E/D's performance is entirely unaffected by variations in power line voltage and frequency.

**PERFORMANCE SURPASSES ALL INDUSTRY STANDARDS**

RUMBLE CONTENT	} 100% better than NARTB standards — better even than standards specified for primary professional recording equipment.
FLUTTER CONTENT	
SPEED REGULATION	

**HOW IT WORKS**

In the new Fairchild E/D turntable speed is changed by changing the speed of the hysteresis-synchronous motor. The speed of the motor is changed by altering the frequency of the current used to drive it.

This current is furnished by a variable-frequency oscillator-amplifier, called the Electronic Control-Regulator. Four frequencies are available which operate the turntable at 16⅔, 33⅓, 45 and 78 rpm respectively. Individual controls also permit the user to adjust each speed ±5%.

The Fairchild E/D can be operated from any AC power line supplying 85 to 135 volts. It can be operated with DC, using a converter — or with storage batteries and a vibrator-inverter. No matter which source is used, the quality and accuracy of turntable performance remain the same.

The Turntable Unit, which incorporates the turntable, hysteresis motor and 2-belt drive, can be purchased without the Electronic Control-Regulator (ECR) and used as a high quality single-speed 33⅓ rpm turntable from a 60-cycle power line. The ECR can be obtained at a later date, and easily mounted in the unitized turntable enclosure.

**PRICES ARE:** Fairchild E/D complete, \$186.50; Turntable Unit (less ECR), \$99.50; Electronic Control-Regulator (ECR) \$94.00; Hardwood Base (shock-mounted) in walnut, mahogany or korina, \$31.50.

See your Fairchild dealer for a demonstration. Literature on request. FAIRCHILD Recording Equipment Co., 10-40 45th Avenue, L. I. C. 1, N. Y.

NEWS BRIEFS (Continued)

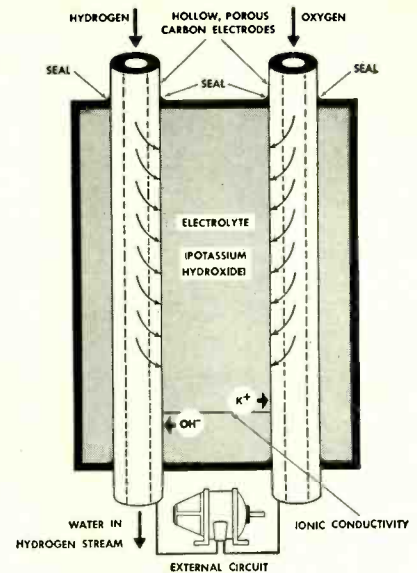

equipment. Ionic conductivity through the electrolyte completes the circuit, positive potassium ions picking up their missing electrons at the oxygen anode. Water formed in the reaction passes from the cell in the hydrogen stream. There is no deterioration of electrodes or electrolyte, and the cell can operate indefinitely as long as "fuel" (oxygen and hydrogen) is supplied to it. Research has indicated that the optimum fuel-cell design will deliver approximately 1 kilowatt from a unit 1 cubic foot in volume. Potential across the terminals is about 1 volt.

As a producer of electrical energy, the fuel cell, developed by the National Carbon Co., depends on a practical and economical source of hydrogen. This gas, at present, is expensive and requires relatively bulky containers.

**AIRCRAFT COLLISION WARNING** device is expected to give pilots 20 seconds' notice of impending disaster. The new detector is said to pick up infra-red radiation from a second plane 2-4 miles away. An Aerojet-operated DC-3 is scheduled to make actual air tests of the system. If the tests are favorable, airlines would probably start installing detectors by the end of 1958.

The system's operation is comparatively simple. A rotating infra-red detector scans a 360° arc around the plane horizontally. The vertical scanning arc is 150°. When another plane is detected, a light flashes on a cockpit dial and an arrow shows the direction of the intruder. Two additional detectors cover the area above and below the plane. Any intruder within 800 feet sets off a second warning, giving the pilot sufficient time to avoid an accident.

Scheduled airlines have been worried about the collision danger for two years or more. A 1955 survey showed a large number of near collisions. The Aerojet-designed system will give only limited protection against high-speed jets, and its usefulness would be confined to clear weather. Storms limit the range of the

**FREE!**

# ALLIED'S 1958 CATALOG

**404** value-packed PAGES

the only **COMPLETE** catalog for everything in electronics

Get ALLIED'S 1958 Catalog—it's complete, up-to-date—404 pages packed with the world's largest selection of quality electronic equipment at lowest, money-saving prices. Get every buying advantage at ALLIED: fastest shipment, expert personal help, lowest prices, guaranteed satisfaction...



## WORLD'S LARGEST STOCKS

- Latest Hi-Fi Systems and Components
- Money-Saving, Build-Your-Own KNIGHT-KITS
- Recorders and Supplies
- Public Address Systems and Accessories
- TV Tubes, Antennas and Accessories
- Amateur Receivers, Transmitters, Station Gear
- Test & Lab Instruments
- Specialized Industrial Electronic Equipment
- Huge Listings of Parts, Tubes, Transistors, Tools, Books



### EASY-PAY TERMS:

Only 10% down, up to 18 months to pay. Available on orders over \$45. Fast handling—no red tape.

featuring:

### ALLIED'S money-saving knight-kits:

Finest electronic equipment in money-saving kit form. Over 50 quality kits available—Hi-Fi amplifier, tuner and speaker kits, Hobby kits, Test Instruments, Ham kits (see our KNIGHT-KIT values elsewhere in this publication). ALLIED KNIGHT-KITS are easiest to build and they SAVE YOU MORE.

### EVERYTHING IN HI-FI

World's largest selection of quality Hi-Fi components and complete music systems—available for immediate shipment from stock. Save on exclusive ALLIED-Recommended complete systems. Own the best in Hi-Fi for less!



*Our 37th Year*

# ALLIED RADIO

World's Largest Electronic Supply House

NOVEMBER, 1957

send for the leading electronic supply guide

**FREE!**

ALLIED RADIO CORP., Dept. 2-L7  
100 N. Western Ave., Chicago 80, Ill.

Send FREE 404-Page 1958 ALLIED Catalog

Name \_\_\_\_\_

Address \_\_\_\_\_

City \_\_\_\_\_ Zone \_\_\_\_\_ State \_\_\_\_\_

the  
finest...  
from  
every  
point  
of  
view...

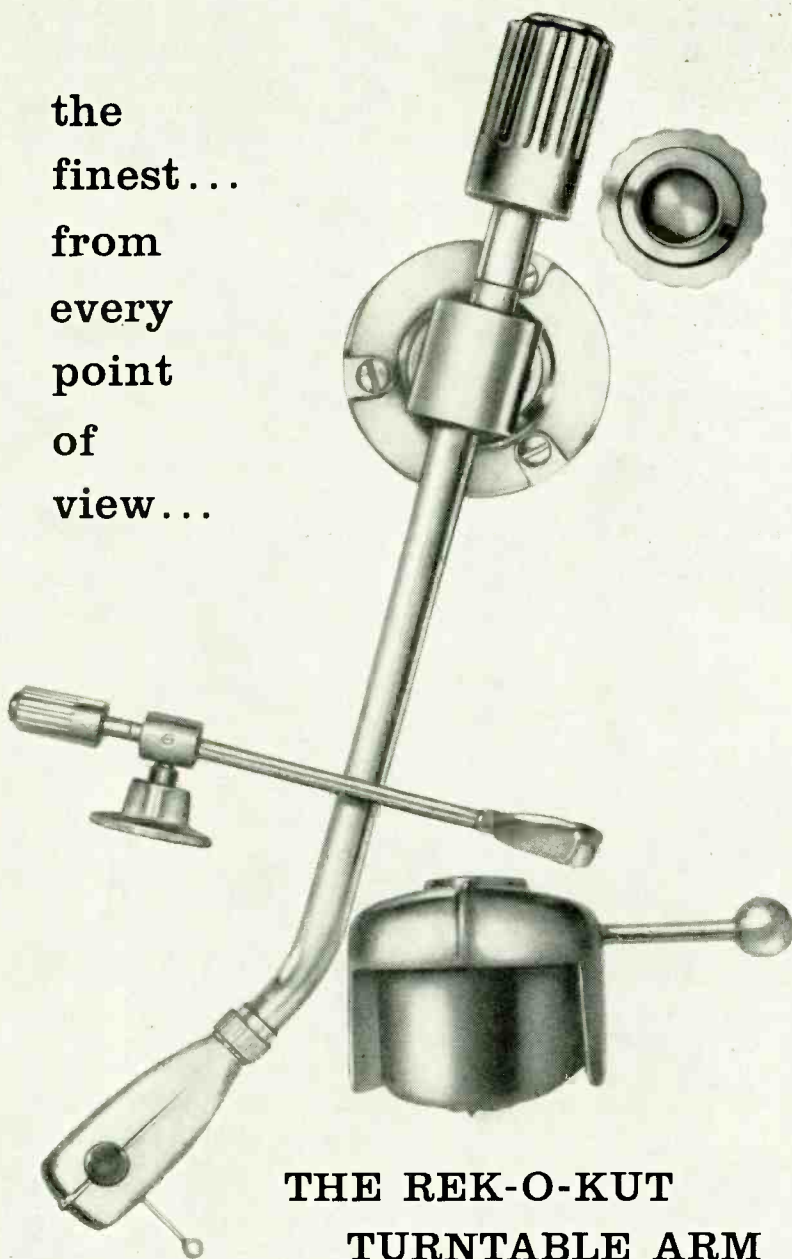

## THE REK-O-KUT TURNTABLE ARM

Most superbly styled of all arms — this is also the *one* turntable arm that offers best compliance, lowest resonance, optimum tracking . . . to give you better sound! That is why it is the *one* arm invariably sold with every turntable — *outselling all other turntable arms combined!* Write for catalog and free Strobe disc. \$26.95 12" Arm, \$29.95 16" Arm.

**EXCLUSIVE FEATURES!** • Patented sealed Versa-Twin bearing pivot provides superior horizontal compliance. • For free vertical motion, arm pivots are mounted in chrome steel ball-bearing races. • Micrometer gram weight adjustment gives correct stylus pressure without need for stylus gauge. • Has easy arm-height adjustment. Takes all popular cartridges.



**REK-O-KUT**

HIGH FIDELITY TURNTABLES—TURNTABLE ARMS  
38-19 108th St., Corona 68, N.Y.

### NEWS BRIEFS (Continued)

detectors. However, a large majority of near-collisions occur in clear weather. If these could be avoided, the system would be worth while.

**LESS ELECTRICITY IN THE AIR** was reported by D. J. L. Koenigsfeld, director of the Magnetic Observatory of Manhay at the University of Liege in Belgium. The air 1 meter above the ground has been found in the past to have a normal potential of 100 volts in relation to the earth. Now, as measured in Belgium, it is only 15 volts.

According to Professor H. R. Byers, chairman of the Department of Meteorology at the University of Chicago, an increase in ionization of the lower part of the earth's atmosphere could create a layer of ionized air similar to the ionosphere. Such a layer might result in a new kind of radio blackout. It might also affect weather, reducing the number of lightning flashes in thunderstorms.

Whether this change in potential is part of a normal cycle or what may be causing the drop was not stated, although the suggestion was made that it could possibly be due to the injection of radioactive material into the atmosphere.

**SIX NEW TV STATIONS**, scattered throughout the country, started off the fall season:

WWL-TV, New Orleans, La.....	4
WIIIC, Pittsburgh, Pa.....	11
WAVY-TV, Portsmouth-Norfolk, Va.....	10
KTCA-TV, St. Paul-Minneapolis, Minn.....	2
KSPR-TV, Casper, Wyo.....	7
WFGA-TV, Jacksonville, Fla.....	12
WENS, Pittsburgh, Pa., channel 16, quit telecasting on Aug. 31.	

The following stations changed call letters since our last report:

KVIP-TV, Redding, Calif.....	7
(formerly KVIP)	
WKXP-TV, Lexington, Ky.....	27
(formerly WLAP-TV)	
WJZ-TV, Baltimore, Md.....	13
(formerly WAAM)	

These developments change the total figures to 508 operating U. S. stations (419 vhf and 89 uhf), 26 of which are noncommercial (6 uhf).

**A FUNDAMENTAL RADAR PATENT**, which gives the Government a royalty-free license, was granted to Col. William R. Blair, retired U. S. Army Signal Corps scientist.

The pulse-echo method of direction finding and ranging covered by the patent was conceived by Colonel Blair before 1930. The system was developed during the 1930's at Signal Corps laboratories at Fort Monmouth, N. J.

In early 1937, a complete, workable radar set was demonstrated for the Secretary of War and members of Congress. Due to the high degree of secrecy surrounding the development of radar, a patent application was not filed by the Signal Corps until June, 1945, and the passage of a private bill by Congress was necessary to remove the bar of late filing. END

Cast your ballot for a successful future!

# 256 I.C.S. COURSES



Whether you stand at a machine or sit at a desk . . . whether you're making \$75 a week or \$75 hundred a year . . . whether your interest is Power Plants or Paper Pulp, Advertising or Electronics . . . chances are I.C.S. has exactly the course you need to get ahead.

I.C.S. is not only the oldest and largest correspondence school. It also offers the most courses. 256 in all. Each one success-proved by graduates who rose to top technical and administrative positions. Chief engineers. Superintendents. Foremen. Managers. Executive assistants.

I. C. S. Courses cover bedrock facts and theory plus practical, on-the-job applications. No skimping. Texts

are prepared by leading business and industrial authorities working with I.C.S. editors and educators. They are constantly being reviewed and revised in line with current developments.

As an I.C.S. student, you study in your spare time, set your own pace. No time lost getting to class or waiting for slower students to catch up. If you wish, I.C.S. will make progress reports to your employer. You win recognition as a "comer," one who is ready to move ahead. Thousands of students report pay increases and promotions within a few months of enrollment. All graduates win the coveted, approved I. C. S. diploma.

**3 FREE BOOKS!** Check the subject that interests you in the coupon below. I. C. S. will rush you (1) a special book outlining your opportunities in this field, (2) the 32-page gold mine of career tips, "How to Succeed," (3) a sample I. C. S. lesson (Math.) demonstrating the famous "I. C. S. Method." "X" MARKS OPPORTUNITY.



**For Real Job Security—Get an I. C. S. Diploma! I. C. S., Scranton 15, Penna.**

Accredited Member,  
National Home Study Council

## INTERNATIONAL CORRESPONDENCE SCHOOLS



BOX 23910K, SCRANTON 15, PENNA.

(Partial list of 257 courses)

Without cost or obligation, send me "HOW TO SUCCEED" and the opportunity booklet about the field BEFORE which I have marked X (plus sample lesson):

**ARCHITECTURE and BUILDING CONSTRUCTION**

- Air Conditioning
- Architecture
- Arch. Drawing and Designing
- Building Contractor
- Building Estimator
- Carpentry and Millwork
- Carpenter Foreman
- Heating
- Interior Decoration
- Painting Contractor
- Plumbing
- Reading Arch. Blueprints

**ART**

- Commercial Art
- Magazine & Book Illus.
- Show Card and Sign Lettering
- Sketching and Painting

**AUTOMOTIVE**

- Automobiles
- Auto Body Rebuilding and Refinishing
- Auto Engine Tuneup
- Auto Technician

**AVIATION**

- Aero-Engineering Technology
- Aircraft & Engine Mechanic

**BUSINESS**

- Accounting
- Advertising
- Business Administration
- Business Management
- Cost Accounting
- Creative Salesmanship
- Managing a Small Business
- Professional Secretary
- Public Accounting
- Purchasing Agent
- Salesmanship
- Salesmanship and Management
- Traffic Management

**CHEMICAL**

- Analytical Chemistry
- Chemical Engineering
- Chem. Lab. Technician
- Elements of Nuclear Energy
- General Chemistry
- Natural Gas Prod. and Trans.
- Petroleum Prod. and Engr.
- Professional Engineer (Chem)
- Pulp and Paper Making

**CIVIL ENGINEERING**

- Civil Engineering
- Construction Engineering
- Highway Engineering
- Professional Engineer (Civil)
- Reading Struc. Blueprints
- Structural Engineering
- Surveying and Mapping

**DRAFTING**

- Aircraft Drafting
- Architectural Drafting
- Drafting Machine Design
- Electrical Drafting
- Mechanical Drafting
- Sheet Metal Drafting
- Structural Drafting

**ELECTRICAL**

- Electrical Engineering
- Elec. Engr. Technician
- Elec. Light and Power
- Practical Electrician
- Practical Lineman
- Professional Engineer (Elec)

**HIGH SCHOOL**

- High School Diploma

- Good English
- High School Mathematics
- Short Story Writing

**LEADERSHIP**

- Industrial Foremanship
- Industrial Supervision
- Personnel-Labor Relations
- Supervision

**MECHANICAL and SHOP**

- Diesel Engines
- Gas-Elec. Welding
- Industrial Engineering
- Industrial Instrumentation
- Industrial Metallurgy
- Industrial Safety
- Machine Design
- Machine Shop Practice
- Mechanical Engineering
- Professional Engineer (Mech)
- Quality Control
- Reading Shop Blueprints
- Refrigeration and Air Conditioning
- Tool Design
- Tool Making

**RADIO, TELEVISION**

- General Electronics Tech.

- Industrial Electronics
- Practical Radio-TV Eng'g
- Practical Telephony
- Radio-TV Servicing

**RAILROAD**

- Car Inspector and Air Brake
- Diesel Electrician
- Diesel Engr. and Fireman
- Diesel Locomotive

**STEAM and DIESEL POWER**

- Combustion Engineering
- Power Plant Engineer
- Stationary Diesel Engr.
- Stationary Fireman

**TEXTILE**

- Carding and Spinning
- Cotton Manufacture
- Cotton Warping and Weaving
- Loom Fixing Technician
- Textile Designing
- Textile Finishing & Dyeing
- Throwing
- Warping and Weaving
- Worsted Manufacturing

Name \_\_\_\_\_ Age \_\_\_\_\_ Home Address \_\_\_\_\_  
 City \_\_\_\_\_ Zone \_\_\_\_\_ State \_\_\_\_\_ Working Hours \_\_\_\_\_ A.M. to P.M. \_\_\_\_\_  
 Occupation \_\_\_\_\_

Canadian residents send coupon to International Correspondence Schools, Canadian, Ltd., Montreal, Canada. . . . Special tuition rates to members of the U. S. Armed Forces.

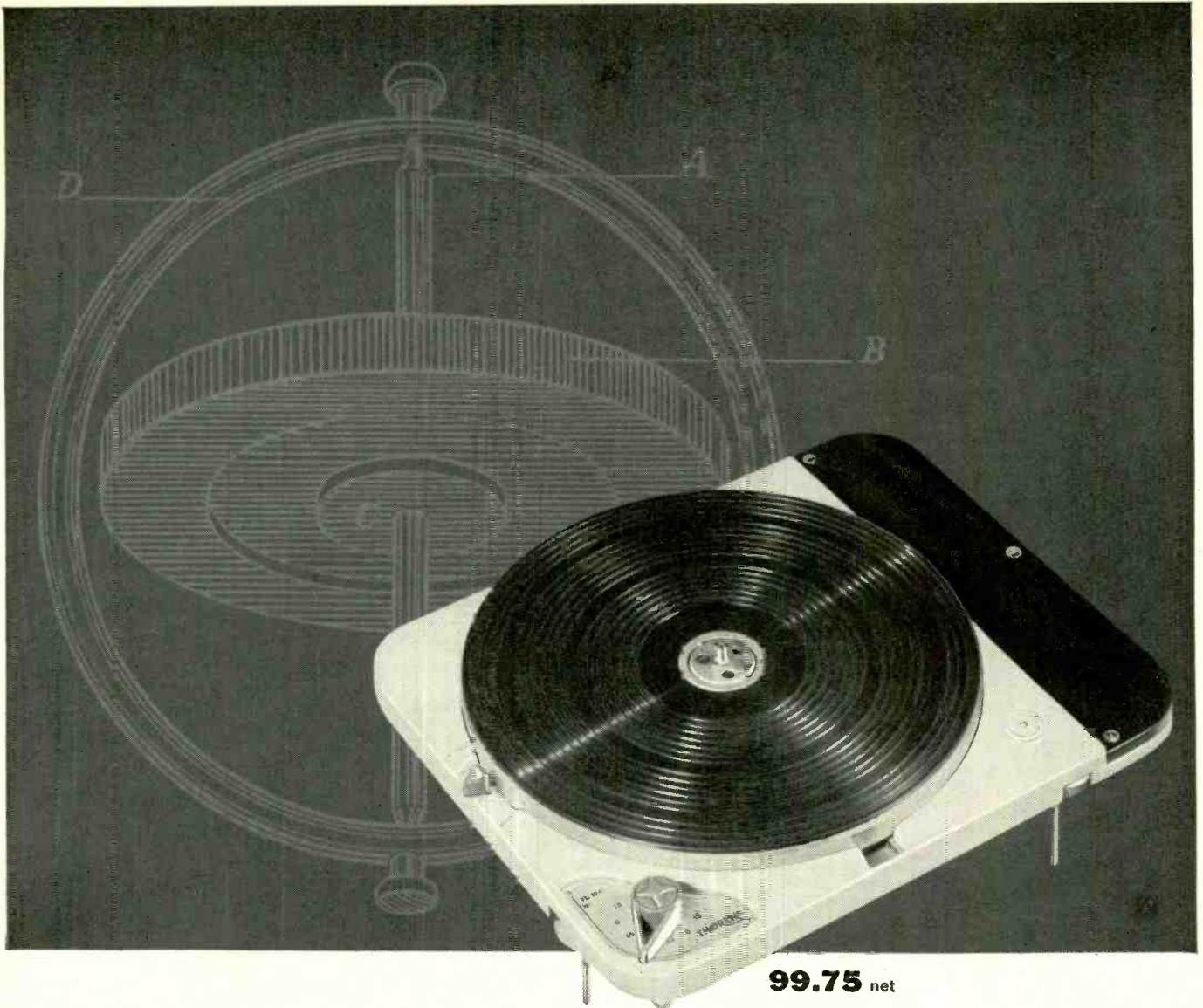

99.75 net

## NEW 12" PRECISION TURNTABLE

### OUTSTANDING FEATURES

Four speeds, each with  $\pm 3\%$  speed adjustment. Built-in illuminated strobe disk for all speeds. Built-in level bubble and leveling screws. Precision 4-pole motor, extra-compliant belt-drive and idler system plus exclusive Thorens Roto-Drive principle, provide complete vibration isolation, absolutely constant speed. Provision for easily changing arms without leaving unsightly permanent marks—just replace low-cost arm mounting board, available for 12" or 16" arms in various finishes. Easy to mount, the TD-124 requires only  $2\frac{3}{4}$ " clearance below mounting board. Furnished with attached line cord, shielded cable and solder plate.

**Gyro-like Roto-Drive gives new Thorens TD-124 absolute speed uniformity. Heavier than 16-inch turntables, yet it starts, stops in less than  $\frac{2}{3}$  turn!**

How to get the heaviest possible turntable for smooth, absolutely quiet operation without sacrificing fast starts and stops.

That's the problem Thorens engineers faced when they set out to build the best four-speed, 12-inch, hi-fi turntable money can buy. You'll be amazed at the simplicity of their solution.

The new TD-124 really has two turntables in one: (1) a heavy 10-lb. rim-concentrated, cast-iron flywheel (outweighs 16" aluminum turntables) (2) a light aluminum cover, or turntable proper. An exclusive, Thorens-originated clutch couples or decouples the light aluminum table to the heavy flywheel for instant starts and stops. What's more, the Thorens double turntable system gives you the weight of a cast-iron table (3 times as heavy as aluminum) without danger of attracting any pickup magnet. And with this unique construction, your pickup gets magnetic shielding from motor or transformer hum fields by the iron turntable.

Ask your hi-fi dealer to show you the Thorens TD-124. Better yet, arrange to hear one of those critical, slow piano records on the TD-124. If you don't know who your dealer is, write Thorens Company, Dept. E117, New Hyde Park, N. Y. 79



# THORENS

SWISS MADE PRODUCTS

HI-FI COMPONENTS · LIGHTERS · SPRING-POWERED SHAVERS · MUSIC BOXES

RADIO-ELECTRONICS

# GET IN ON THE TV



L. C. Lane, B.S., M.A.  
President, Radio-Television  
Training Association. Executive  
Director, Pierce School  
of Radio & Television.

# BOOM!

## TRAIN FOR A TOP-PAY JOB AS A TELEVISION TECHNICIAN NO PREVIOUS EXPERIENCE NEEDED — study AT HOME in your SPARE TIME

Next to the atom and hydrogen bombs, the biggest noise being made today is by the booming radio-television-electronics industry.

Now, while the boom is on in full force, is the time for you to think about how you can share in the high pay and good job security that this ever-expanding field offers to trained technicians.

Just figure it out for yourself. There are more than 400 television broadcasting stations operating right now

and hundreds more to be built; more than 34 million sets in the country and sales increasing daily. Soon moderately priced color television sets will be on the market and the color stampede will be on.

All these facts mean that good jobs will be looking for good men. You can be one of those men if you take advantage of my training now — the same training that has already prepared hundreds of men for successful careers in the radio-television-electronics field.



### LEARN BY DOING

As part of your training I give you the equipment you need to set up your own home laboratory and prepare for a BETTER-PAY TV JOB. You build and keep an Electromagnetic TV RECEIVER designed and engineered to take any size picture tube up to 21-inch, (10-inch tube furnished. Slight extra cost for larger sizes.) . . . also a Super-Het Radio Receiver, AF-RF Signal Generator, Combination Voltmeter-Ammeter-Ohmmeter, C-W Telephone Transmitter, Public Address System, AC-DC Power supply. Everything supplied, including all tubes.

**EARN WHILE YOU LEARN** Almost from the very start you can earn extra money while learning by repairing radio-TV sets for friends and neighbors. Many of my students earn enough each week to pay for their entire training from spare time earnings . . . start their own profitable service business.

**FCC COACHING COURSE** Qualifies you for Higher Pay! Given to all my students AT NO EXTRA COST. Helps you qualify for the TOP JOBS in Radio-TV that demand an FCC license! Full training and preparation at home for your FCC license.

## Radio-Television Training Association

52 EAST 19th STREET • NEW YORK 3, N. Y.

Licensed by the State of New York • Approved for Veteran Training

No experience necessary! You learn by practicing with professional equipment I send you. Many of my graduates who now hold down good paying technician jobs started with only grammar school training.

If you have previous Armed Forces or civilian radio experience you can finish your training several months earlier by taking my FM-TV Technician Course. Train at home with kits or parts, plus equipment to build YOUR OWN TV RECEIVER. ALL FURNISHED AT NO EXTRA COST!

After you finish your home study training in the Radio-FM-TV Technician Course or the FM-TV Technician Course you get two weeks, 50 hours, of intensive Laboratory work on modern electronic equipment at our associate school in New York City, Pierce School of Radio & Television.

**COLOR TV TECHNICIAN COURSE**—All new! Learn the latest. Be prepared for those Color TV servicing profits ahead! Contains the most up-to-date servicing data, procedures and circuits. For men with radio or TV training or experience.

### RADIO-FM-TV TECHNICIAN TRAINING

### FM-TV TECHNICIAN TRAINING

**Sylvania Now-Sponsoring  
RTTA's Color TV  
Technician Course**  
One of the nation's  
largest electronics man-  
ufacturers and mar-  
keters Sylvania Electric  
Products Inc. in its con-  
tinuing effort to co-  
operate with independent  
service dealers is now  
sponsoring the RTTA  
Color Television Tech-  
nician Course. Available  
to Authorized Sylvania  
Dealers.

## VETERANS!

My School fully approved to train Veterans under new Korean G. I. Bill. Don't lose your school benefits by waiting too long. Write discharge date on coupon.

YOU GET  
THESE  
free!



### MAIL THIS COUPON TODAY!

Mr. Leonard C. Lane, President  
RADIO-TELEVISION TRAINING ASSOCIATION  
Dept. RE-11D, 52 East 19th Street, New York 3, N. Y.  
Dear Mr. Lane: Send me your NEW FREE BOOK, FREE  
SAMPLE LESSON that will show me how I can make TOP  
MONEY IN TELEVISION. I understand I am under no  
obligation.

(PLEASE PRINT PLAINLY)

Name \_\_\_\_\_ Age \_\_\_\_\_

Address \_\_\_\_\_

City \_\_\_\_\_ Zone \_\_\_\_\_ State \_\_\_\_\_

- Color TV Technician Course
- Radio-FM-TV Technician Course
- FM-TV Technician Course
- TV Studio Technician Course

**VETERANS!**  
Write discharge date

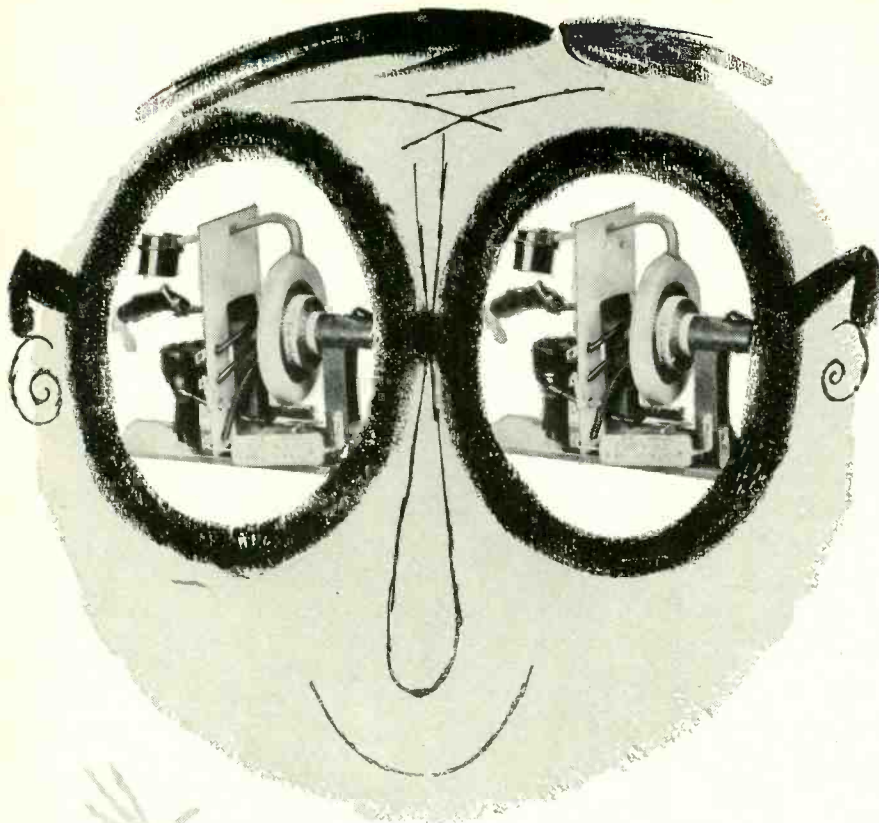

## Seeing Double?

**SURE...THEY LOOK ALIKE BECAUSE  
THEY ARE EXACTLY ALIKE**

Each Merit product of the same type is exactly the same as another—both in construction and appearance.

**COMPARE IT WITH MERIT**

Take a Merit product off the shelf. Compare it with any other similar product on the market. You'll find Merit *is* superior!

**COMPARE IT WITH MERIT**

Only Merit live tests its products to insure uniform quality.



# MERIT

MERIT COIL AND TRANSFORMER CORP.  
4427 North Clark Street · Chicago 40, Illinois

## Correspondence



### BETTER BASS—CORRECTION

In my article "Better Bass Response," published in the September issue, I stated (page 34) that the flare cutoff of the Klipschorn is about 50 cycles. I was mistaken — the K-horn uses a 40-cycle flare.

One other statement in the article may be misleading to some readers. The sentence reads, "Below its cutoff frequency, a horn acts as a mass coupled to the driver cone." This is quite true — it acts as a mass coupled to the cone *as well* as retaining to some degree the resistive characteristic of horn loading. In other words, a finite horn of fairly large throat area does not abruptly unload its driver at cutoff frequency. The transition is more gradual than graphs based on theoretically infinite horns indicate. Moreover, the throat impedance of such a horn *never* reaches zero, but approaches a small finite value.

I should perhaps have made this point more emphatically in the article. Unfortunately, to go into an explanation of the various factors involved in the performance of various commercial horn designs below theoretical flare cutoff would require a separate article.

GEORGE L. AUGSPURGER  
*Los Angeles, Calif.*

### HORN CUTOFF

*Dear Editor:*

This concerns Mr. Augspurger's article in the September issue and his letter of correction.

I'd like to point out that the horn has a property of unloading gradually, rather than abruptly at the so-called cutoff point. My paper "A Note on Acoustic Horns" (*Proceedings of the IRE*, Vol. 33, No. 17, pages 447-49, July, 1945) shows the actual throat impedance, both resistive and reactive components, to be continuous and finite through the point of cutoff.

Actually, the useful impedance of a horn can be made available down to about 80% of the cutoff frequency. Thus in our Klipschorn, referred to by Mr. Augspurger, the design cutoff due to taper is 40.5 cycles, calculated on the shortest length of a string stretched from throat to mouth. Taking the mean path, the taper cutoff calculates to about 37 cycles. The response is down 10 db at 32 cycles (relative to 100 cycles) so 32 cycles is taken as the practical cutoff, though wave propagation and sound pressure are still being produced to below 30 cycles.

I hope that you can use this authentic data. It seems to me rather to be



**RCA** offers you the  
 finest training  
 at home in  
 Radio-TV  
 electronics,  
 TV servicing,  
 Color TV



**SEND FOR THIS FREE  
 BOOK NOW!**

**Pay-as-you-learn. You need pay for only one study group at a time. Practical work with very first lesson. All text material and equipment is yours to keep. Courses for the beginner and advanced student.**



**RCA INSTITUTES, INC.**  
 A SERVICE OF RADIO CORPORATION OF AMERICA  
 350 WEST FOURTH STREET, NEW YORK 14, N.Y.

In Canada—RCA Victor Company, Ltd.,  
 5001 Cote de Liesse Rd., Montreal 9, Que.

NOVEMBER, 1957

RCA Institutes, Inc., Home Study Dept. RE-117  
 350 West Fourth Street, New York 14, N. Y.  
 Without obligation, send me FREE 52 page CATALOG on Home Study Courses in Radio, Television and Color TV. No Salesman will call.

Name .....  
 Please Print

Address.....

City..... Zone..... State.....

KOREAN VETS! Enter discharge date.....  
 To save time, paste coupon on postcard

## Versatile as a one-man band

(Our apologies,  
Mr. Petrillo!)



### Centralab Model B Control

Try a Model B just once and you'll see why we blow our horn about this 15/16" control that adapts readily to virtually any application.

Universal, fluted, knurled-type shaft fits all knobs — split knurl, shallow flat, deep flat, half-round, round.

KB-Fastatch switches snap on, to convert control to switch-type unit.

Sound like music to your ears? It does to other servicemen! That's why Centralab distributors are selling Model B's to beat the band. Order your supply now.



**Centralab** A DIVISION OF GLOBE-UNION INC.  
922K EAST KEEFE AVENUE • MILWAUKEE 1, WISCONSIN  
Y-1458

### CORRESPONDENCE (Continued)

regretted that such a large mass of the published material is derived from hearsay instead of from authentic sources. This is not by way of criticizing Mr. Augspurger, whom I admire, nor his papers which have been more factual than most, but I feel these things should be checked before rather than after publication. For this, I'd be inclined to pin the responsibility on the publisher. You undoubtedly realize how many people feel a printed item is true, just because it is printed. This really puts a terrific moral responsibility on the publisher to try and keep his articles factual.

Hope, Ark.

PAUL W. KLIPSCH

(The publishers of this magazine — and of most other responsible technical magazines, we hope — make every effort to be certain that the articles printed are correct and factual. In some fields, however, the authorities themselves differ as to what constitutes the facts, and nowhere is this so true as in the field of loudspeakers and their associated equipment. We could find authorities to check our articles, of course, but who could we find to check the authorities? — *Editor*)

### WANTS CARTOONS

Dear Editor:

I am beginning to miss the cartoons in your magazine. Once upon a time you had anywhere from 5 to 10 cartoons in my favorite magazine. Now I can hardly find them. Not only that, but they seem to be shrinking in size, too. How come?

St. Louis, Mo.

FRANK ALLROY

### . . . ELIMINATED

Dear Editor:

I have noted your cartoons for some years now and to me they are getting worse all the time. Maybe there is something wrong with my sense of humor, but I wish you would cut them out and give us live reading matter instead. How about it?

Chicago, Illinois

HAROLD DICKENS

(More cartoons? No cartoons? What do our readers want? Drop us a postcard with your vote.—*Editor*)

### HIGH PERVEANCE?

Dear Editor:

In the February, 1957, issue (page 119), under the heading of 25CD6-GB I note you use the term high-perveance. I have checked and can find no definition of perveance. I would appreciate it, if you would enlighten me as to the meaning of this word.

Niles, Ohio

JACK RICHARDS

The term "perveance" is an attempt to get a factor somewhat resembling that of straight dc ohmic resistance. (Plate resistance, as you know, refers to ac resistance as measured by small voltage changes near the operating point.) Thus, the perveance of a tube is a function (in a diode, where the term was first used) of the area of the

# Learn TELEVISION-RADIO

## Servicing or Communications by Practicing at Home in Spare Time

WITHOUT EXTRA CHARGE you get special NRI kits developed to give actual experience with TV-Radio equipment. You build, test, experiment with receiver or broadcasting circuits. All equipment yours to keep.



**NRI Has Trained Thousands for Successful Careers in TV-Radio**

### Have the High Pay, Prestige, Good Future of a Skilled TV-Radio Technician

People look up to and depend on the Technician, more than ever before. Offices, plants, homes everywhere are obliged to buy his knowledge and services. His opportunities are great and are increasing. Become a TV-Radio Technician. At home, and in your spare time, you can learn to do this interesting, satisfying work—qualify for important pay. To ambitious men everywhere here in the fast growing Television-Radio field is rich promise of fascinating jobs, satisfaction and prestige as well as increasing personal prosperity.

### Increased Opportunities in Growing Field

A steady stream of new Electronic products is increasing the job and promotion opportunities for Television-Radio Technicians. Right now, a solid, proven field of opportunity for good pay is servicing the tens of millions of Television and Radio sets now in use. The hundreds of TV and Radio Stations on the air offer interesting jobs for Operators and Technicians.

### More Money Soon—Make \$10 to \$15 a Week Extra Fixing Sets in Spare Time

NRI students find it easy and profitable to start fixing sets for friends and neighbors a few months after enrolling. Picking up \$10, \$15 and more a week gives substantial extra spending money. Many who start in spare time soon build full time TV-Radio sales and service businesses.

**Act Now—See What NRI Can Do for You**

NRI has devoted over 40 years to developing simplified practical training methods. You train at home. Get practical experience, learn-by-doing. Address: NATIONAL RADIO INSTITUTE, Washington 16, D. C.



**Studio Engr., Station KATV**  
"I am now Studio Engineer at Television Station KATV. Before enrolling for the NRI Course, I was held back by limitation of a sixth grade education." BILLY SANCHEZ, Pine Bluff, Ark.

**Has All the Work He Can Do**  
"Since finishing NRI Course I have repaired more than 2,000 TV and Radio sets a year. NRI training certainly proved to be a good foundation." H. R. GORDON, Milledgeville, Ga.

**Has Good Part Time Business**  
"Quite early in my training I started servicing sets. Now have completely equipped shop. My NRI training is the backbone of my progress." E. A. BREDA, Tacoma, Wash.

**The Tested Way To Better Pay** **See Other Side**   
CUT OUT AND MAIL CARD NOW

**SAMPLE LESSON AND CATALOG BOTH FREE**

NO STAMP NEEDED!  
WE PAY POSTAGE

This card entitles you to Actual Lesson on Servicing, shows how you learn Television-Radio at home. You'll also receive 64-Page Catalog.

**NATIONAL RADIO INSTITUTE, Dept. A Washington 16, D. C.**

Please mail me the FREE sample lesson and 64-Page Catalog. (No Salesman will call.)

Name.....Age.....

Address.....

City.....Zone.....State.....

ACCREDITED MEMBER, NATIONAL HOME STUDY COUNCIL



**Technical "KNOW-HOW" Can Give You Interesting, Important Work  
LEARN-BY-DOING with Kits NRI Sends at No Extra Charge**



**YOU BUILD AC-DC Superhet Receiver**

NRI Servicing Course includes all needed parts. By introducing defects you get actual servicing experience practicing with this modern receiver. Learn-by-doing.

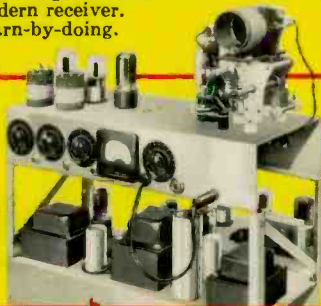

**YOU BUILD Signal Generator**

You build this Signal Generator. Learn how to compensate high frequency amplifiers, practice aligning typical I.F. amplifiers in receiver circuits. Make tests, conduct experiments.

**YOU BUILD Broadcasting Transmitter**

As part of NRI Communications Course you build this low power Transmitter, learn commercial broadcasting operators' methods, procedures. Train for your FCC Commercial Operator's License.

**YOU BUILD Vacuum Tube Voltmeter**

Use it to earn extra cash fixing neighbors' sets; bring to life theory you learn from NRI's easy-to-understand texts.



# For Higher Pay, Better Jobs Be a Television-Radio Technician



**Servicing Needs More Trained Men**

Portable TV, Hi-Fi, Transistor Radios, Color TV are making new demands for trained Technicians. Good opportunities for spare time earnings or a business of your own.



J. E. Smith, Founder

**Train at Home the NRI Way Famous for Over 40 Years**

NRI is America's oldest and largest home study Television-Radio school. The more than 40 years' experience training men for success, the outstanding record and reputation of this school—benefits you in many ways. NRI methods are tested, proven. Successful graduates are everywhere, from coast to coast, in small towns and big cities. You train in your own home, keep your present job while learning. Many successful NRI men did not finish high school. Let us send you an actual lesson, judge for yourself how easy it is to learn.

**Broadcasting Offers Satisfying Careers**

4000 TV and Radio stations offer interesting positions. Govt. Radio, Aviation, Police, Two-Way Communications are growing fields. Trained Radio-TV Operators have a bright future.



**No Experience Necessary—NRI Sends Many Kits for Practical Experience**

You don't have to know anything about electricity or Radio to understand and succeed with NRI Courses. Clearly written, well-illustrated NRI lessons teach TV-Radio-Electronic principles. You get NRI kits for actual experience. All equipment is yours to keep. You learn-by-doing. Mailing the postage-free card may be one of the most important acts of your life. Do it now. Reasonable tuition. Low monthly payments available. Address: NATIONAL RADIO INSTITUTE, Washington 16, D. C.

**NRI Graduates Do Important Work**



**Now Quality Control Chief Understand**  
"Had no other training in Radio before enrolling, obtained job working on TV amplifiers before finishing course. Now Quality Control Chief." T. R. FAVAROLO, Norwich, N. Y.

**NRI Course Easy to Understand**  
"I opened my own shop before receiving my diploma. I have had to hire extra help. I am independent in my own business." D. P. CRESSEY, Stockton, Cal.

**Works on Color-TV**  
"NRI changed my whole life. If I had not taken the course, probably would still be a fireman, struggling along. Now Control Supervisor at WRCA-TV." J. F. MELINE, New York, N. Y.

FIRST CLASS  
Permit No. 20-R  
(Sec. 34.9, P. L. & R.)  
Washington, D.C.

**BUSINESS REPLY CARD**

No Postage Stamp Necessary if Mailed in the United States

POSTAGE WILL BE PAID BY

NATIONAL RADIO INSTITUTE

Washington 16, D. C.

**SAMPLE LESSON  
64-page CATALOG  
both FREE**

**See Other Side  
for more  
information on  
the Tested Way  
to Better Pay**

**CORRESPONDENCE (Continued)**

cathode and the distance between it and the anode. In a triode tube, the grid enters the picture and the perveance is a function of the product of the grid - and cathode - plate spacing and the cathode - plate spacing, as well as of the element areas. With other factors constant, perveance increases with cathode area and with less spacing between cathode and the first element outside the cathode.

A standard formula for perveance for a tube is:

$$G = \frac{i_k}{e_b^{3/2}}$$

where  $i_k$  is the cathode current and  $e_b^{3/2}$  is the 3/2 power of the plate voltage.

(The current in a tube tends to rise not linearly with the voltage but in proportion to the 3/2 power of the voltage.) That is the reason for the peculiar expression.—*Editor*

**AGAINST LICENSING AND PAY TV**

*Dear Editor:*

I agree with Mr. Henry ("Licensing Not the Answer," page 21, September issue). Licensing will just mean an extra expense for the technician. I am a part-time technician myself and do not believe this business needs a licensed technician. I suggest that all who oppose licensing write and let no such move go through. Licensed technicians can pull underhanded deals too. If no complaint is lodged, they get away with it too.

I am also opposed to pay television. The enjoyment of television is the convenience of having the program brought into your own livingroom, *without cost*. If I have to pay to see a movie, I might as well go to the theater. The airways are free. What's wrong with the present method of sponsoring programs? I say those who oppose pay TV better speak up now and not permit any such move to go through. **BRIAN CHIN KING**  
*New York, N. Y.*

**RED AND FUZZBALL**

*Dear Editor:*

I wish to report that I thoroughly enjoyed the article "Practical Color TV Installation" by Bob Middleton. I am looking forward to Part II. Part I was clear and very well received. Give us more. **D. WADE PITTMAN**  
*Fountain Head, Tenn.*

*Dear Editor:*

You can bet our boots I enjoyed the article titled "Practical Color TV Installation."

Sure would like to see more written like that. The fact that Bob Middleton tells *where* the adjustments are and what they look like helps me a lot. I mean the things around the picture tube (color), beam positioning magnets, etc. **PETE KOWALCHIK**  
*Kingston, Penn.*

(And more in the same vein. No opposing votes yet.—*Editor.*) **END**

**EXCITINGLY NEW COMPONENTS FROM H. H. SCOTT.....**

**Get the facts! 11 brand new H. H. Scott components. NEW styling...NEW features... a completely NEW line for '58.**

Want all the facts on the most exciting hi fi line of the year? Then write for H. H. Scott's new free catalog.

Get all the technical data on Scott's brand new Model 300 AM-FM tuner. Get technical specs on our completely redesigned 210F amplifier.

Read all about the new features we've added to our famous '99" complete amplifier.

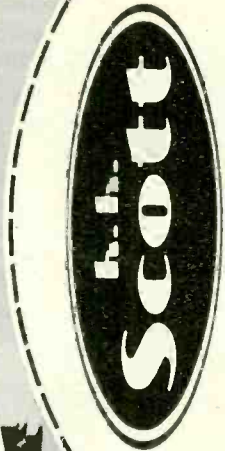

**H. H. Scott, 111 Powdermill Road, Maynard, Massachusetts**  
Export Dept: Telesco International Corp.  
36 West 40th Street, New York City

*Rush me your new catalog E-11 and complete technical specifications on H. H. Scott components for '58.*

NAME .....

ADDRESS .....

CITY ..... STATE .....

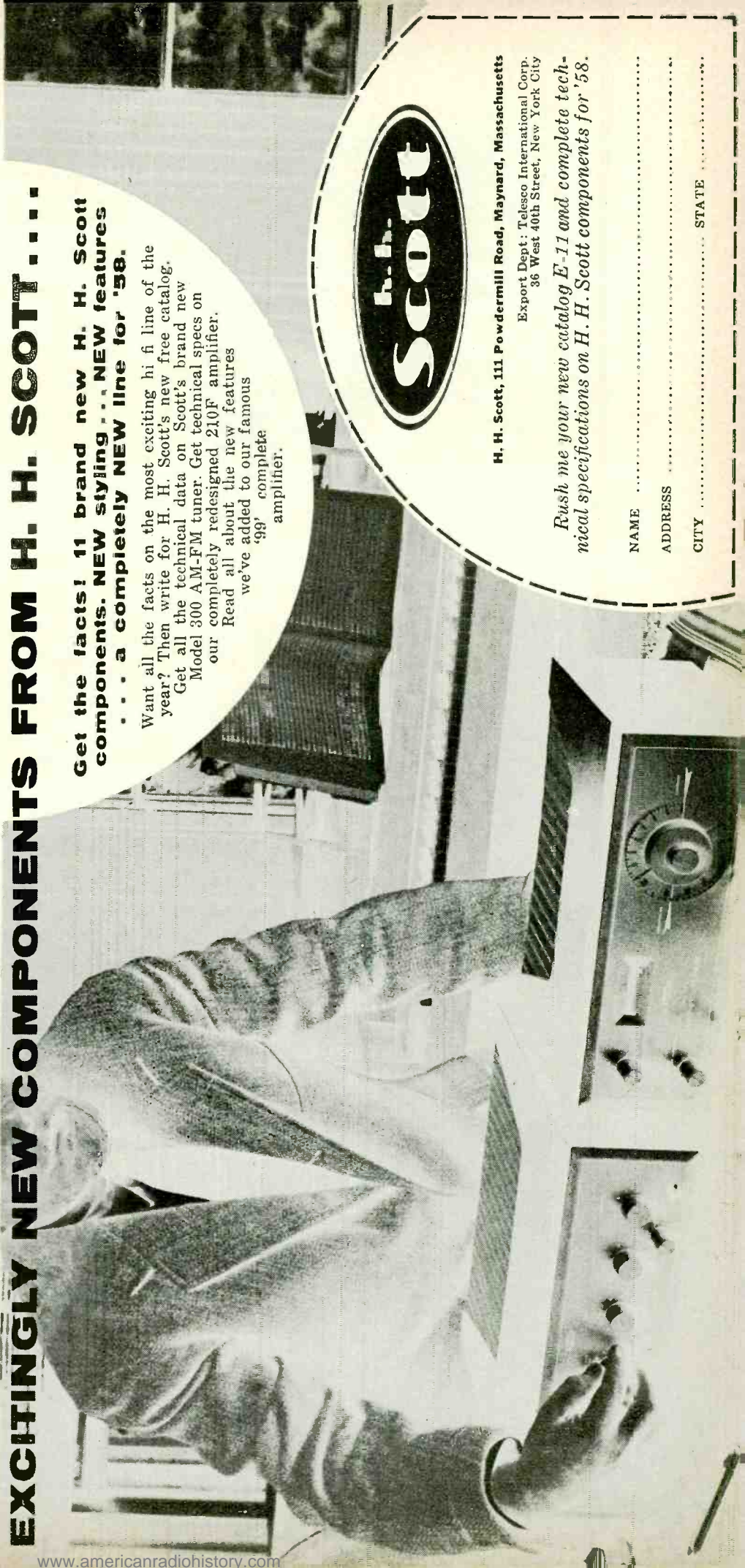

# how long would it take you to solve this service problem?

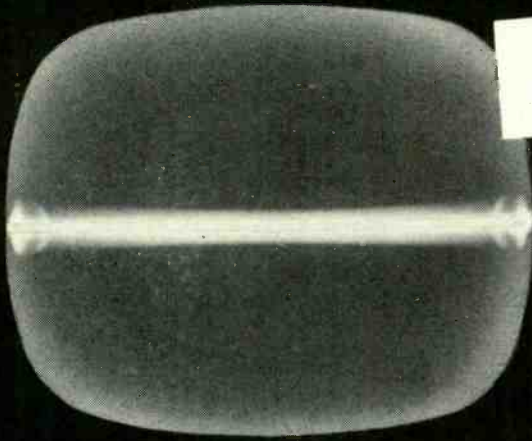

(Based on an actual case history taken from the Howard W. Sams book "TV Servicing Guide")

**SYMPTOM:**  
Loss of Vertical Sweep

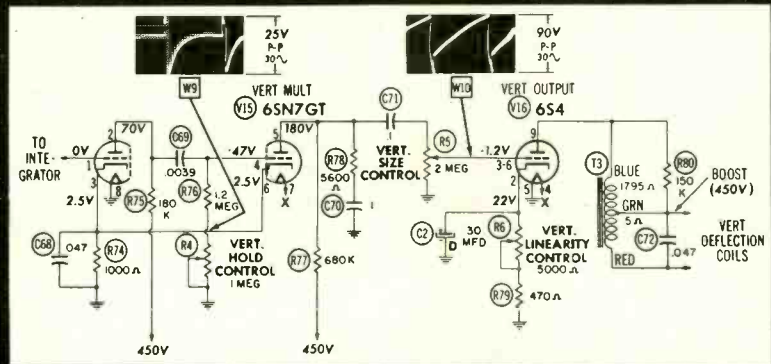

## PHOTOFACT helps you lick problems like this in just minutes for only \* **2½¢** per model!

Let's take a look at this problem: This trouble symptom is present when there is no driving signal to the vertical deflection coils and when the horizontal scanning is normal. Look for the following possible causes:

1. Defective multivibrator or output tubes
2. Open coupling capacitors C71 or C69
3. Open linearity control R6 or cathode resistor R79
4. Open size control R5
5. Open output transformer T3

With the applicable PHOTOFACT Folder at your fingertips, you trouble-shoot and solve this problem in just minutes. Here's how:

Using the Tube Placement chart (you'll find it in every PHOTOFACT TV Folder) you can quickly locate and check

the multivibrator and output tubes.

Tubes okay?—then: Check waveform at grid of vertical output tube (W10). Wave shapes and peak-to-peak values appear right on the PHOTOFACT Standard Notation schematic. Waveform correct?—then: Check for open R6, or R79 or for faulty components in the output plate circuit. The DC resistance of the vertical output transformer and the lead colors are also shown right on the schematic.

Waveform incorrect?—then: Check voltages at the pins of the multivibrator tube. They're right on the exclusive Standard Notation schematic.

Whatever the trouble, you'll locate it faster and easier with a PHOTOFACT Folder by your side. Be sure to use the complete Replacement Parts List to select the proper replacement for the repair.

Use the servicing method you prefer—checking of waveform, voltage or resistance—you'll find all the information you need at your finger-tips in PHOTOFACT. For only \*2½¢ per model, PHOTOFACT helps you solve your service problems in just minutes—helps you service more sets and earn more daily!

\*Based on the average number of models covered in a single set of PHOTOFACT Folders.



**MONEY BACK GUARANTEE!**

Got a tough repair? Try this—at Howard W. Sams' own risk: see your Parts Distributor and buy the proper PHOTOFACT Folder Set covering the receiver. Then use it on the actual repair. If PHOTOFACT doesn't save you time, doesn't make the job easier and more profitable for you, Howard W. Sams wants you to return the complete Folder Set direct to him and he'll refund your purchase price promptly. GET THE PROOF FOR YOURSELF—TRY PHOTOFACT NOW!

**FREE**



**FOR SERVICE TECHNICIANS ONLY**

Fill out and mail coupon today for Free subscription to the Sams Photofact Index — your up-to-date guide to virtually any receiver model ever to come into your shop. Send coupon now.

**HOWARD W. SAMS & CO., INC.**

Howard W. Sams & Co., Inc.  
2205 E. 46th St., Indianapolis 5, Ind.

Put me on your mailing list to receive the Sams Photofact Index and Supplements. My (letterhead) (business card) is attached.

I'm a Service Technician:  full time;  part time

My Distributor is: \_\_\_\_\_

Shop Name \_\_\_\_\_

Attn: \_\_\_\_\_

Address: \_\_\_\_\_

City \_\_\_\_\_ Zone \_\_\_\_\_ State \_\_\_\_\_

The

"GEM" of them all--

ROHN



### TOWERS

Rohn Towers are the only complete line of towers... from the No. 6 "all purpose" tower which is most suitable for TV installations, to the giant No. 40 communications tower. Hot-dipped galvanized finish is featured in the entire line.

No. 6 Tower is ideal for heights 50-120'. Features Magic Triangle construction that assures great strength, stability and durability. Stocking Rohn No. 6 Towers means you can fulfill practically all tower needs!

No. 40 Communications Tower for extreme heights and heavy duty work. Uses large 18" equilateral triangular design which allows heights up to 300 ft.

or lesser heights where considerable strength is needed. Used widely



ly for radio communication and micro wave throughout U. S. Sell this tower for these requirements existing in your locality.

Both the No. 6 and No. 40 Towers are in 10' sections and are easily installed without special equipment.

Also available: No. 30 Towers and a unique space-saver PACKAGED TOWER, the latter available in heights from 24' to 64'.

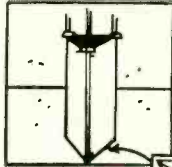

### NEW BASE

"Same day" installation base available NOW for No. 6 and P. T. Tower! Use this unique base that permits "on the spot" erection and "on the ground" assembly. Towers are then merely "walked up" into position.

### Telescoping MASTS

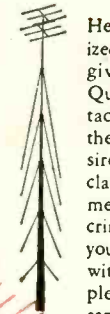

Heavy-duty hot-dipped galvanized steel tubing and rigid joints give extraordinary strength. Quick installation... mast attached to base—antenna fixed, then mast hoisted quickly to desired height. Utilizes special clamp and guy ring arrangement. Flanged interior section; crimped exterior section gives you a mast that won't pull apart with unequalled stability. Complete with guy rings and necessary erection parts. In 20, 30, 40 and 50 ft. sizes. Bases and ground mounts available.

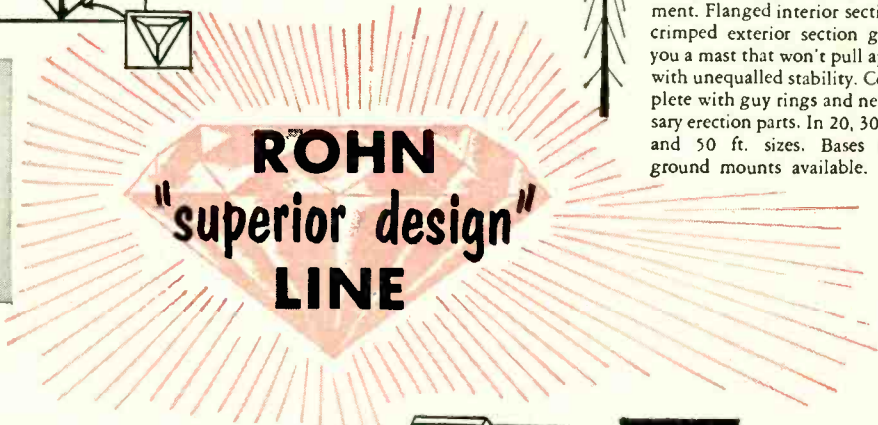

### TUBING



True hot-dipped galvanized tubing coating both inside and out. Machined to perfection... available with 6" expanded end or plain—and in either 5' or 10' lengths. Painted if desired also available.



### ACCESSORIES

A full line of accessories are available—all—Hot Dipped Galvanizing! Some of the items are: rotor posts, house brackets, eave brackets, peak and flat roof mounts, instant drive-in bases, hinged base sections, telescoping mast bases, guying brackets, UHF antenna mounts, erection fixtures, and a variety of mounts and supports for masts or tubing.



### ROOF TOWERS

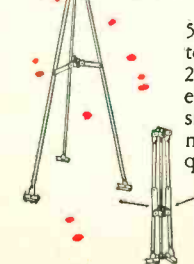

5 "Superior Design" roof towers in heights from 2½' to 10'. Most all models are collapsible for easy shipping and storage. All models ideal answer for quick, inexpensive roof top installation. Get full information on this fine line of roof towers.



### ROHN offers these exclusives

- Hot-dipped galvanizing
- unequalled design and engineering
- mass production for low cost
- universal customer acceptance
- pioneer manufacturers
- complete line.

**SEND COUPON TODAY!**

"World's Largest Exclusive Manufacturer of TV-Communications Towers"

**ROHN** Manufacturing Co.

116 LIMESTONE, BELLEVUE

PEORIA, ILLINOIS PHONE 4-9156

GET COMPLETE DETAILS AND CATALOG NOW

Rohn Mfg. Co., 116 Limestone, Bellevue Peoria, Ill.

Gentlemen: Please rush me complete details on the full line of Rohn Towers and Accessories.

FIRM \_\_\_\_\_

NAME \_\_\_\_\_ TITLE \_\_\_\_\_

ADDRESS \_\_\_\_\_

CITY \_\_\_\_\_ STATE \_\_\_\_\_

**A wonderful offer  
from the  
RAYTHEON RECEIVING  
TUBE DISTRIBUTORS  
who sponsor the  
RAYTHEON BONDED  
DEALER PROGRAM**



at no added cost

# GROUP LIFE INSURANCE

(Administered and Underwritten by New England Mutual Life Insurance Co.)

for <sup>Registered\*</sup> Raytheon Bonded Electronic Technicians  
who by preference use Raytheon Receiving Tubes

Now, Registered Bonded Dealers can gain personal security for themselves and their families — automatically increase their life insurance coverage, through their regular purchases of Raytheon Receiving Tubes. The amount of coverage is determined by the quantity of Receiving Tubes the dealer buys.

The New England Mutual Life Insurance Company has created a Group Life Insurance Plan for Raytheon Bonded Electronic Technicians — a plan offered exclusively by Raytheon Distributors who sponsor the Bonded Dealer Program. Any such Distributor who meets the necessary requirements for

setting up a Group Life Insurance Plan for Bonded Dealers may give them this valuable protection without the necessity of a physical examination. Check with your Raytheon Sponsoring Distributor and see if he has it available to you.

If you're not at present a Raytheon Bonded Dealer, better see your Sponsoring Distributor as to whether you can qualify. You'll find being a Raytheon Bonded Dealer a real asset to you. You'll find using Raytheon quality receiving tubes is a big help, too.

*\*Only Registered Raytheon Bonded Dealers who own their businesses and have the necessary shop facilities and equipment to qualify for Bonding, are eligible for Group Insurance under this plan.*



## RAYTHEON MANUFACTURING COMPANY

Receiving and Cathode Ray Tube Operations

NEWTON 58, MASS. 55 Chapel Street  
CHICAGO, ILL. 9501 Grand Ave. (Franklin Park)  
ATLANTA 6, GA. 1150 Zanolite Rd. N.E.  
LOS ANGELES 7, CALIF. 2419 So. Grand Ave.

Raytheon makes all these

Receiving and Picture Tubes, Reliable Subminiature and Miniature Tubes, Semiconductor Diodes and Transistors, Nucleonic Tubes, Microwave Tubes.





# What Does F.C.C. Mean To You?

## What is the F. C. C.?

F. C. C. stands for Federal Communications Commission. This is an agency of the Federal Government, created by Congress in 1934 to regulate all radio communication and radio and television broadcasting in the United States.

## What is an F. C. C. Operator License?

The F. C. C. requires that only qualified persons be allowed to install, maintain, and operate electronic communications equipment, including radio and television broadcast transmitters. To determine who is qualified to take on such responsibility, the F. C. C. gives technical examinations. Operator licenses are awarded to those who pass these examinations. There are different types and classes of operator licenses, based on the type and difficulty of the examination passed.

## What are the Different Types of Operator Licenses?

The F. C. C. grants three different types (or groups) of operator licenses—commercial radiotelePHONE, commercial radioteleGRAPH, and amateur.

**COMMERCIAL RADIOTELEPHONE** operator licenses are those required of technicians and engineers responsible for the proper operation of electronic equipment involved in the transmission of voice, music, or pictures. For example, a person who installs or maintains two-way mobile radio systems or radio and television broadcast equipment must hold a radiotelePHONE license. (A knowledge of Morse code is NOT required to obtain such a license.)

**COMMERCIAL RADIOTELEGRAPH** operator licenses are those required of the operators and maintenance men working with communications equipment which involves the use of Morse code. For example, a radio operator on board a merchant ship must hold a radioteleGRAPH license. (The ability to send and receive Morse is required to obtain such a license.)

**AMATEUR** operator licenses are those required of radio "hams"—people who are radio hobbyists and experimenters. (A knowledge of Morse code is necessary to be a "ham".)

## What are the Different Classes of RadiotelePHONE licenses?

Each type (or group) of license is divided into different classes. There are three classes of radiotelePHONE licenses, as follows:

(1) **Third Class RadiotelePHONE License.** No previous license or on-the-job experience is required to qualify for the examination for this license. The examination consists of F. C. C. Elements I and II covering radio laws, F. C. C. regulations, and basic operating practices.

(2) **Second Class RadiotelePHONE License.** No on-the-job experience is required for this examination. However, the applicant must have already passed examination Elements I and II. The second class radiotelePHONE examination consists of F. C. C. Element III. It is mostly technical and covers basic radiotelePHONE theory (including electrical calculations), vacuum tubes, transistors, amplifiers, oscillators, power supplies, amplitude modulation, frequency modulation, measuring instruments, transmitters, receivers, antennas and transmission lines, etc.

(3) **First Class RadiotelePHONE License.** No on-the-job experience is required to qualify for this examination. However, the applicant must have already passed examination Elements I, II, and III. (If the applicant wishes, he may take all four elements at the same sitting, but this is

not the general practice.) The first class radiotelePHONE examination consists of F. C. C. Element IV. It is mostly technical covering advanced radiotelePHONE theory and basic television theory. This examination covers generally the same subject matter as the second class examination, but the questions are more difficult and involve more mathematics.

## Which License Qualifies for Which Jobs?

The **THIRD CLASS** radiotelePHONE license is of value primarily in that it qualifies you to take the second class examination. The scope of authority covered by a third class license is extremely limited.

The **SECOND CLASS** radiotelePHONE license qualifies you to install, maintain, and operate most all radiotelePHONE equipment except commercial broadcast station equipment.

The **FIRST CLASS** radiotelePHONE license qualifies you to install, maintain, and operate every type of radiotelePHONE equipment (except amateur, of course) including all radio and television stations in the United States, and in its Territories and Possessions. This is the highest class of radiotelePHONE license available.

## How Long Does it Take to Prepare for F. C. C. Exams?

The time required to prepare for FCC examinations naturally varies with the individual, depending on his background and aptitude. Grantham training prepares the student to pass FCC exams in a minimum of time.

In the *Grantham Correspondence Course*, the average beginner with NO previous experience or training in radioelectronics should obtain his second class radiotelePHONE license after from 200 to 300 hours of study. This same student should then prepare for his first class FCC license in approximately 100 additional hours of study.

In the *Grantham Resident Course*, the time required to complete the course and get your license (under normal circumstances) is as follows:

In the **DAY** course (5 days a week) you should get your second class license at the end of the first 9 weeks of classes, and your first class license at the end of 3 additional weeks of classes. This makes a total of 12 weeks (just a little less than 3 months) required to cover the whole course, from "scratch" through first class.

In the **EVENING** course (2 nights a week) you should get your second class license at the end of the 22nd week of classes and your first class license at the end of 8 additional weeks of classes. This makes a total of approximately

7 months required to cover the whole course, from "scratch" through first class, in the evening course.

The Grantham course is designed specifically to prepare you to pass FCC examinations. All the instruction is presented with the FCC examinations in mind. In every lesson test and pre-examination you are given constant practice in answering FCC-type questions, presented in the same manner as the questions you will have to answer on your FCC examinations.

## Why Choose Grantham Training?

The Grantham Communications Electronics Course is planned primarily to lead to an F.C.C. license, but it does this by TEACHING electronics. This course can prepare you quickly to pass F. C. C. examinations because it presents the necessary principles of electronics in a simple "easy to grasp" manner. Each new idea is tied in with familiar ideas. Each new principle is presented first in simple, everyday language. Then after you understand the "what and why" of a certain principle, you are taught the technical language associated with that principle. You learn more electronics in less time, because we make the subject easy and interesting.

## Is the Grantham Course a "Memory Course"?

No doubt you've heard rumors about "memory courses" or "cram courses" offering "all the exact FCC questions". Ask anyone who has an FCC license if the necessary material can be memorized. Even if you had the exact exam questions and answers, it would be much more difficult to memorize this "meaningless" material than to learn to understand the subject. Choose the school that teaches you to thoroughly understand—choose Grantham School of Electronics.

## Is the Grantham Course Merely a "Coaching Service"?

Some schools and individuals offer a "coaching service" in FCC license preparation. The weakness of the "coaching service" method is that it presumes the student already has a knowledge of technical radio and approaches the subject on a "question and answer" basis. On the other hand, the Grantham course "begins at the beginning" and progresses in logical order from one point to another. Every subject is covered simply and in detail. The emphasis is on making the subject easy to understand. With each lesson, you receive an FCC-type test so you can discover daily just which points you do not understand and clear them up as you go along.

**HERE'S PROOF** that Grantham Students prepare for F.C.C. examinations in a minimum of time. Here is a list of a few of our recent graduates, the class of license they got, and how long it took them:

	License	Wks.
Albert Meehleib, Box 136, Elrama, Pa.	1st	12
Leo Bishop, 37 Calle Contenta, Flagstaff, Ariz.	1st	12
Carl Deare, Jr., P.O. Box 467, Jeanerette, La.	1st	11
Robert Umthun, 1918 Eye St., NW, Washington, D.C.	1st	21
Dan Breece, Station KOVE, Lander, Wyo.	1st	12
Robert Todd, Station WWBG, Bowling Green, Ohio.	1st	13
Jackson York, 1029 N. Quincy St., Arlington, Va.	1st	15
Paul Chuckray, 6874 Weber Rd., Afton, Mo.	1st	11

**OUR GUARANTEE:** If you should fail the F.C.C. exam after finishing our course, we guarantee to give you additional training at NO ADDITIONAL COST. Read details in our free booklet.

## TWO COMPLETE SCHOOLS

To better serve our many students throughout the entire country, Grantham School of Electronics maintains two complete schools—one in Hollywood, California and one in Washington, D.C. Both schools offer the same rapid courses in F.C.C. license preparation, either home study or resident class.

For further details concerning F. C. C. licenses and our training, send for our FREE booklet, "Opportunities in Electronics". Clip the coupon below and mail it to the School nearest you.

Get your First Class Commercial F.C.C. License in 12 weeks by training at



**GRANTHAM SCHOOL OF ELECTRONICS**

HOLLYWOOD DIVISION

1505 N. Western Avenue, Hollywood 27, Calif. Phone: HO 2-1411

WASHINGTON DIVISION

821 - 19th Street, N.W., Washington 6, D.C. Phone: ST 3-3614

NOVEMBER, 1957

## MAIL TO SCHOOL NEAREST YOU

Grantham Schools, Desk 74-S

821 - 19th Street N.W. OR 1505 N. Western Ave.  
Washington 6, D.C. Hollywood 27, Calif.

Please send me your free booklet telling how I can get my commercial F.C.C. license quickly. I understand there is no obligation and no salesman will call.

Name \_\_\_\_\_ Ago \_\_\_\_\_

Address \_\_\_\_\_

City \_\_\_\_\_ State \_\_\_\_\_

I am interested in:  Home Study,  Resident Classes



AR-22



TR-2



TR-4

# CDR ROTORS



TR 11 and 12

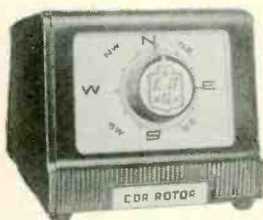

AR 1 and 2

## 5-star feature...

- 1 **the best color TV picture**  
the growth of color TV means an even greater demand for CDR Rotors for pin-point accuracy of antenna direction.
- 2 **a better picture on more stations**  
CDR Rotors add to the pleasure of TV viewing because they line up the antenna perfectly with the transmitted TV signal giving a BETTER picture . . . and making it possible to bring in MORE stations.

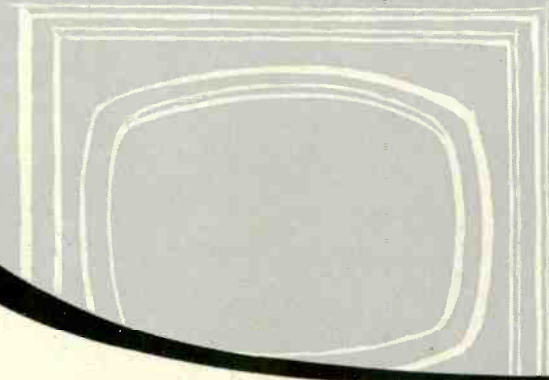

- 3 **tested and proven dependable**  
thousands and thousands of CDR Rotors have proven their dependability over years of unflinching performance in installations everywhere in the nation. Quality and engineering you know you can count on.
- 4 **pre-sold to your customers**  
the greatest coverage and concentration of full minute spot announcements on leading TV stations is working for YOU . . . pre-selling your customers.
- 5 **the complete line**  
a model for every need . . . for every application. CDR Rotors make it possible for you to give your customer exactly what is needed . . . the right CDR Rotor for the right job.

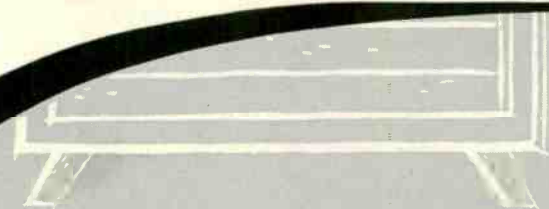

CORNELL-DUBILIER  
SOUTH PLAINFIELD, N. J.



THE RADIART CORP.  
CLEVELAND 13, OHIO

Prepare for a Good Paying Job — Or Your Own Business

Learn PRACTICAL RADIO-TV  
with **25 BIG KITS**

of equipment I send you while  
you train with me . . . for valuable  
shop bench experience . . .



This is the new Sprayberry Training Television receiver, built and tested in sections for greatest instruction value.

I now offer this fine modern oscilloscope to help you learn practical Television servicing.

You will build this powerful short wave and broadcast superhet radio receiver for valuable shop instruction practice.

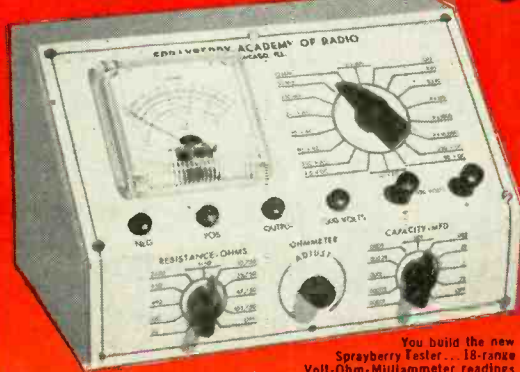
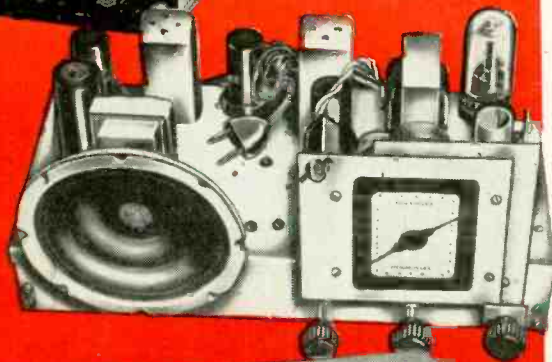

You build the new Sprayberry Tester . . . 18-range Volt-Ohm-Milliammeter readings plus output meter and condenser and resistor substitution selector.

Average cost per lesson  
**ONLY \$3.42**  
Including Kits and Equipment

"I Will Train You at Home in  
**RADIO-TELEVISION**  
On Liberal No Obligation Plan!"

New Equipment! New Lessons! Enlarged Course! The true facts are yours in my big new catalog . . . **YOURS FREE . . .**

**JUST MAIL COUPON!**

I can train and prepare you in as little as 10 months to step into the big opportunity Radio-Television service field. Train *without* signing a binding contract . . . without obligating yourself to pay any regular monthly amounts. You train entirely at home in spare hours . . . you train as fast or as slowly as you wish. You'll have your choice of **THREE SPRAYBERRY TRAINING PLANS** . . . planned for both beginners as well as the more experienced man. Get the true facts about the finest most modern Radio-Training available today . . . just mail the coupon for my big new 56 page fact-filled catalog plus sample lesson—both **FREE**.



Frank L. Sprayberry  
Educational Director

**Train the Practical Way—with Actual Radio-Television Equipment**

My students do better because I train both the mind and the hands. Sprayberry Training is offered in 25 individual training units, each includes a practice giving kit of parts and equipment . . . all yours to keep. You will gain priceless practical experience building the specially engineered Sprayberry Television Training Receiver, Two-Band Radio Set, Signal Generator, Audio Tester and the new Sprayberry 18 range Multi-Tester, plus other test units. You will have a complete set of Radio-TV test equipment to start your own shop. My lessons are regularly revised and every important new development is covered. My students are completely trained Radio-Television Service Technicians.

**NEWEST DEVELOPMENTS**

Your training covers U H F, Color Television, F M, Oscilloscope Servicing, High Fidelity Sound and Transistors.

**See for Yourself . . . Make Your Own Decision . . . Mail Coupon Today!**

The coupon below brings you my big new catalog plus an actual sample Sprayberry Lesson. I invite you to read the facts . . . to see that I actually illustrate every item I include in my training. With the facts in your hands, you will be able to decide. *No salesman will call on you.* The coupon places you under no obligation. Mail it now, today, and get ready for your place in Radio-Television.

**SPRAYBERRY ACADEMY OF RADIO-TELEVISION**

1512 Jarvis Avenue, Dept. 20-U, Chicago 26, Illinois

**Mail This Coupon For Free Facts and Sample Lesson**

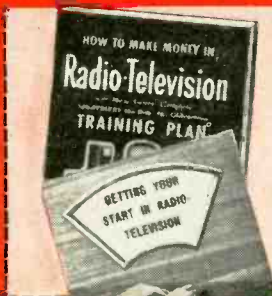

**SPRAYBERRY ACADEMY OF RADIO-TELEVISION**  
1512 Jarvis Ave., Dept. 20-U, Chicago 26, Ill.

Please rush all information on your ALL-NEW Radio-Television Training Plan. I understand this does not obligate me and that no salesman will call upon me. Include New Catalog and Sample Lesson FREE.

Name \_\_\_\_\_ Age \_\_\_\_\_  
Address \_\_\_\_\_  
City \_\_\_\_\_ Zone \_\_\_\_\_ State \_\_\_\_\_

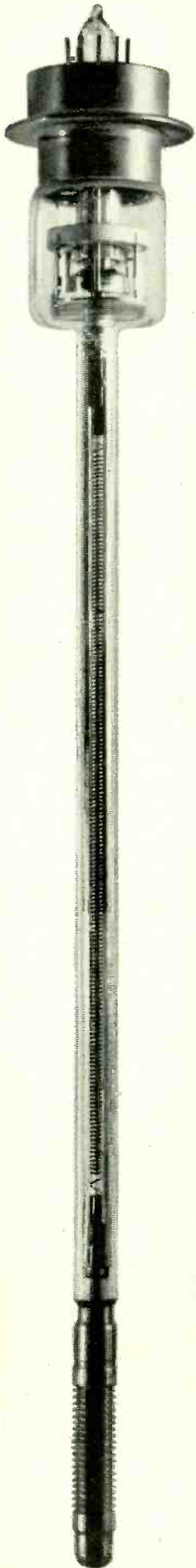

## A GREAT AMPLIFIER TUBE IS PERFECTED FOR TELEPHONY

A new transcontinental microwave system capable of carrying four times as much information as any previous microwave system is under development at Bell Laboratories. A master key to this development is a new traveling-wave tube of large frequency bandwidth.

The traveling-wave amplifying principle was discovered in England by Dr. Rudolf Kompfner, who is now at Bell Laboratories; the fundamental theory was largely developed by Labs scientist Dr. John Pierce. Subsequently the tube has been utilized in various ways both here and abroad. At the Laboratories it has been perfected to meet the exacting performance standards of long distance telephony. And now for the first time a traveling-wave tube will go into large-scale production for use in our nation's telephone systems.

The new amplifier's tremendous bandwidth greatly simplifies the practical problem of operating and maintaining microwave communications. For example, in the proposed transcontinental system, as many as 16 different one-way radio channels will be used to transmit a capacity load of more than 11,000 conversations or 12 television programs and 2500 conversations. Formerly it would have been necessary to tune several amplifier tubes to match each channel. In contrast, a single traveling-wave tube can supply all the amplification needed for a channel. Tubes can be interchanged with only very minor adjustments.

The new amplifier is another example of how Bell Laboratories research creates new devices and new systems for telephony.

*Left:* A traveling-wave tube. *Right:* Tube being placed in position between the permanent magnets which focus the electron beam. The tube supplies uniform and distortionless amplification of FM signals over a 500 Mc band. It will be used to deliver an output of five watts.

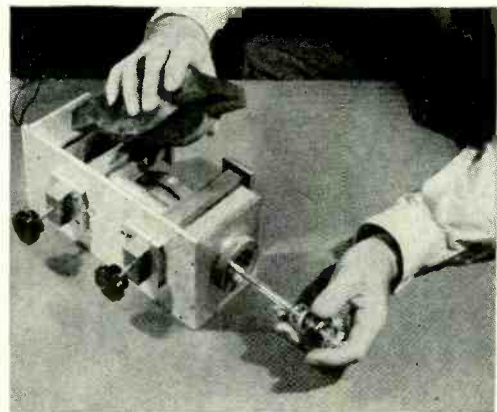

**BELL TELEPHONE LABORATORIES**

WORLD CENTER OF COMMUNICATIONS RESEARCH AND DEVELOPMENT



RADIO-ELECTRONICS

**NEW! 12-WATT Williamson-type HIGH FIDELITY INTEGRATED AMPLIFIER HF12**



with Preamplifier, Equalizer & Control Section  
KIT \$34<sup>95</sup> WIRED \$57<sup>95</sup>

Compact, beautifully packaged & styled. Provides complete "front-end" facilities and true high fidelity performance. Direct tape head & magnetic phono inputs with NARTB (tape) & RIAA (phono) feedback equalizations. 6-tube circuit, dual triode for variable turnover bass & treble feedback-type tone controls. Output Power: 12 w cont., 25 w pk. IM Dist. (60 & 5000 cps @ 4:1): 1.5% @ 12 w; 0.55% @ 6 w; 0.3% @ 4 w. Freq. Resp.: 1 w:  $\pm 0.5$  db 12 cps - 50 kc; 12 w:  $\pm 0.5$  db 25 cps - 20 kc. Harmonic Dist.: 20 cps: 2% @ 4.2 w; 1/2% @ 2.5 w; 30 cps: 2% @ 11 w; 1/2% @ 6.3 w; 40 cps: 1% @ 12 w; 1/2% @ 9.3 w; 2000 cps: 1/2% @ 12 w; 10 kc: 1% @ 10 w; 1/2% @ 6 w. Transient Resp: excellent square wave reproduction (4 usec rise-time); negligible ringing, rapid settling on 10 kc square wave. Inverse Feedback: 20 db. Stability Margin: 12 db. Damping Factor: above 8, 20 cps - 15 kc. Speaker Connections: 4, 8, 16 ohms. Tone Control Range: @ 10 kc,  $\pm 13$  db; @ 50 cps,  $\pm 16$  db. Tubes: 2-ECC83/12AX7, 1-ECC82/12AU7, 2-EL84, 1-EZ81. Size: HWD: 3 3/4" x 12" x 8 1/4". 13 lbs. Mounts in or out of cabinet.

**NEW! 50-WATT Ultra-Linear HIGH FIDELITY POWER AMPLIFIER**

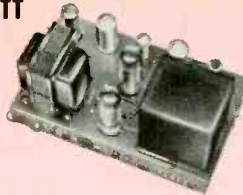

HF50 KIT \$57<sup>95</sup> WIRED \$87<sup>95</sup>

Like the HF60 shown below, the HF50 features virtually absolute stability, flawless transient response under either resistive or reactive (speaker) load, and no bounce or flutter under pulsed conditions. Extremely high quality output transformer with extensively interleaved windings, 4, 8, & 16 ohm speaker connections, grain-oriented steel, & fully potted in seamless steel case. Otherwise identical to HF60. Output Power: 50 w cont., 100 w pk. IM Distortion (60 & 6000 cps @ 4:1): below 1% at 50 w; 0.5% @ 45 w. Harmonic Dist.: below 0.5% between 20 cps & 20 kc within 1 db of rated power. Freq. Resp. at 1 w:  $\pm 0.5$  db 6 cps - 60 kc;  $\pm 0.1$  db 15 cps - 30 kc at any level from 1 mw to rated power; no peaking or raggedness outside audio range. All other specs identical to HF60 below. Matching cover Model E-2, \$4.50.



**NEW! 50-WATT Ultra-Linear HIGH-FIDELITY**

**INTEGRATED POWER AMPLIFIER HF52** with Preamplifier, Equalizer & Control Section  
KIT \$69<sup>95</sup> WIRED \$109<sup>95</sup>

Combines a power amplifier section essentially identical to the HF50 power amplifier with a preamp-equalizer control section similar to HF20 below. Provision for use with electronic crossover network & additional amplifier(s). See HF50 for response & distortion specs: HF60 for square wave response, rise-time, inverse feedback, stability margin, damping factor, speaker connections; HF20 for preamplifier, equalizer & control section description. Hum & noise 60 db below rated output on magnetic phono input (8 mv input for rated output), & 75 db below rated output on high level inputs (0.6 v input for rated output). Matching cover Model E-1, \$4.50.

**7 NEW BEST BUYS by**



**NEW HIGH FIDELITY PREAMPLIFIER**

#HF61A KIT \$24<sup>95</sup>, WIRED \$37<sup>95</sup>

With Power Supply: #HF61 KIT \$29<sup>95</sup>, WIRED \$44<sup>95</sup>

Will not add distortion or detract from the wide-band or transient response of the finest power amplifiers at any control settings. High quality feedback circuitry throughout plus the most complete control & switching facilities. Heavy-gauge solid brushed brass panel, concentric controls, one-piece brown enamel steel cabinet for lasting attractive appearance. Feedback-type, sharp cut-off (12 db/octave) scratch & rumble filters. Low-distortion feedback equalization: 5 most common recording curves for LPs & 78s including RIAA. Low-distortion feedback tone controls: provide large boost or cut in bass or treble with mid-freqs & volume unaffected. Centralab printed-circuit Senior "Compentrol" loudness control with concentric level control, 4 hi-level switched inputs (tuner, tv, tape, aux.) & 3 low-level inputs (separate front panel low-level input selector permits concurrent use of changer & turntable). Proper pick-up loading & attenuation provided for all quality cartridges. Hum bal. control. DC superimposed on filament supply, 4 convenience outlets. Extremely flat wideband freq. resp.:  $\pm 1$  db 8-100,000 cps;  $\pm 0.3$  db 12-50,000 cps. Extremely sensitive. Negligible hum, noise, harmonic or IM distortion. Size: 4-7/8" x 12-5/16" x 4-7/8". 8 lbs.



**NEW 60-WATT Ultra-Linear HIGH FIDELITY POWER AMPLIFIER #HF60** with ACRO TO-330 OUTPUT TRANSFORMER  
KIT \$72<sup>95</sup> WIRED \$99<sup>95</sup>

Superlative performance, obtained through finest components & circuitry. EF86 low-noise voltage amplifier direct-coupled to 6SN7GTB cathode coupled phase inverter driving a pair of Ultra-Linear connected push-pull EL34 output tubes operated with fixed bias. Rated power output: 60 w (130 w peak). IM Distortion (60 & 6000 cps @ 4:1): less than 1% at 60 w; less than 0.5% at 50 w. Harmonic Distortion: less than 0.5% at any freq. between 20 cps & 20 kc within 1 db of 60 w. Sinusoidal Freq. Resp.: at 1 w: 35 kc at any level from 1 mw to rated power; no peaking or raggedness outside audio range. Square Wave Resp.: excellent from 20 cps to 25 kc, 3 usec rise-time. Sensitivity: 0.55 v for 60 w. Damping Factor: 17. Inverse Feedback: 21 db. Stability Margin: 16 db. Hum: 90 db below rated output. ACRO TO-330 Output Transformer (fully potted). Speaker Taps: 4, 8, 16 ohms. GZ34 extra-rugged rectifier (indirectly-heated cathode eliminates high starting voltage on electrolytics & delays B+ until amplifier tubes warm up). Input level control. Panel mount fuse holder. Both bias and DC - balance adjustments. Std octal socket provided for pre-amplifier power take-off. Size: 7" x 14" x 8". 30 lbs. Matching cover Model E-2 \$4.50.



**NEW COMPLETE with Preamplifier, Equalizer & Control Section 20-WATT Ultra-Linear Williamson-Type HIGH FIDELITY AMPLIFIER #HF-20**  
KIT \$49<sup>95</sup> WIRED \$79<sup>95</sup>

A low-cost, complete-facility amplifier of the highest quality that sets a new standard of performance at the price, kit or wired. Rated Power Output: 20 w (34 w peak). IM Distortion (60 & 6000 cps/4:1) at rated power: 1.3%. Max. Harmonic Distortion between 20 & 20,000 cps at 1 db under rated power: approx. 1%. Mid-band Harmonic Distortion at rated power: 0.3%. Power Response (20 w):  $\pm 0.5$  db 20-20,000 cps;  $\pm 1.5$  db 10-40,000 cps. Freq. Resp. (1/4 w):  $\pm 0.5$  db 13-35,000 cps;  $\pm 1.5$  db 7-50,000 cps. 5 feedback equalizations for LPs & 78s. Low-distortion feedback tone controls: large boosts or cuts in bass or treble with mid-freqs. & volume unaffected. Loudness control & separate level set control on front panel. Low Z output to tape recorder. 4 hi-level switched inputs: tuner, tv, tape, aux; 2 low-level inputs for proper loading with all cartridges. Hum bal. control. DC superimposed on filament supply. Extremely fine output transformer: interleaved windings, tight coupling, careful balancing, grain-oriented steel. 8 1/2" x 15" x 10". 24 lbs. Matching cover Model E-1, \$4.50.

**NEW COMPLETE with FACTORY-BUILT CABINET - 2-WAY HI-FI SPEAKER SYSTEM #HFS1 \$39<sup>95</sup>**



Genuine 2-way book-shelf size speaker system. Jensen heavy duty 8" woofer (6.8 oz. magnet) & matching Jensen compression-driver exponential horn tweeter with level control. Smooth clean bass & crisp extended highs free of coloration or artificial brilliance. Factory-built tuned bass reflex birch hardwood cabinet (not a kit) constructed to high quality standards. Neutral acoustical grille cloth framed by a smooth-sanded solid birch molding. Freq. Resp. measured 2 ft. away on principal axis in anechoic chamber with 1 watt input - Woofer:  $\pm 4$  db 80-1800 cps; Tweeter:  $\pm 2$  db 2800-10,000 cps; Crossover Region: 1800-2800 cps, shift in level over this region depends on tweeter level control setting. Power-handling capacity: 25 watts. Size: 23"x11"x9". 25 lbs. Wiring Time: 15 min.

33-00 Northern Blvd., L.I.C. 1, N.Y.

Turn page for other EICO ad.

See the "BEST BUYS" NOW IN STOCK at your nearest distributor. Fill out coupon on other side for FREE CATALOG.

Prices 5% higher on West Coast.



the specs prove it . . .  
your **BEST BUY** is  
**EICO**®

for COLOR & Monochrome TV servicing

**FREE CATALOG**

shows you **HOW TO SAVE 50%**  
on 50 models of top quality  
professional test equipment.  
**MAIL COUPON NOW!**

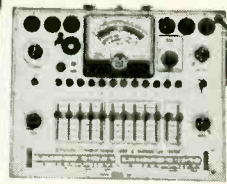

**NEW! DYNAMIC  
CONDUCTANCE  
TUBE & TRANSISTOR  
TESTER #666**  
KIT \$69<sup>95</sup> WIRED \$109<sup>95</sup>

**COMPLETE** with steel cover and handle.  
SPEED, ease, unexcelled accuracy & thoroughness. Tests all receiving tubes (and picture tubes with adapter). Composite indication of Gm, Gp & peak emission. Simultaneous sel of any 1 of 4 combinations of 3 plate voltages, 3 screen voltages, 3 ranges of continuously variable grid voltage (with 5% accurate pot). New series-string voltages: for 600, 450, 300 ma types. Sensitive 200 ua meter. 5 ranges meter sensitivity (1% shunts & 5% pot). 10 SIX-position lever switches: freepoint connection of each tube pin. 10 pushbuttons: rapid insert of any tube element in leakage test circuit & speedy sel. of individual sections of multi-section tubes in merit tests. Direct-reading of inter-element leakage in ohms. New gear-driven rollechart. Checks n-p-n & p-n-p transistors: separate meter readings of collector leakage current & Beta using internal dc power supply. Deep-etched satin aluminum panel; rugged grey wrinkle steel cabinet. CRA Adapter \$4.50

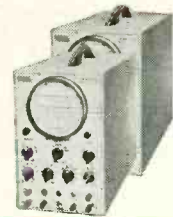

**5" PUSH-PULL  
OSCILLOSCOPE  
#425**  
KIT \$44.95  
Wired \$79.95

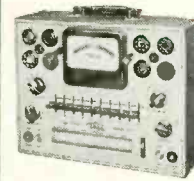

**TUBE TESTER  
#625**  
KIT \$34.95  
Wired \$49.95  
• tests 600 mil series string type tubes  
• illuminated roll-chart

Pix Tube Test Adapter .....\$4.50



Sep. volt-  
meter  
&  
ammeter

KIT  
\$29.95

Wired  
\$38.95

**6V & 12V BATTERY ELIMINATOR &  
CHARGER #1050**



Sep. hi-gain RF  
& lo-gain audio  
inputs.  
Special noise  
locator. Calibra-  
ted wattmeter.

KIT \$24.95  
Wired \$39.95

**DELUXE MULTI-SIGNAL TRACER #147**

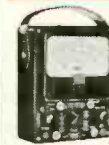

**20,000 Ohms/Volt  
MULTIMETER #565**  
KIT 24.95  
Wired \$29.95



**1000 Ohms/Volt  
MULTIMETER  
#536**  
KIT \$12.90  
Wired \$14.90



Reads 0.5 ohms  
-500 megs, 10  
mmd-5000 mfd,  
power factor.

KIT  
\$19.95  
Wired  
\$29.95

**R-C BRIDGE & R-C-L COMPARATOR  
#950B**



**VTMV PROBES**

Peak-to-Peak	KIT \$4.95	Wired \$6.95
RF	\$3.75	\$4.95
High Voltage Probe-1		\$6.95
High Voltage Probe-2		\$4.95

**SCOPE PROBES**

Demodulator	\$3.75	\$5.75
Direct	\$2.75	\$3.95
Low Capacity	\$3.75	\$5.75

EICO, 33-00 Northern Blvd.  
Long Island City 1, N. Y.

C-11

Show me **HOW TO SAVE 50%** on Test Equip-  
ment and Hi-Fi. Send me **FREE** Catalog and  
name of neighborhood distributor.

Name.....  
Address.....  
City.....Zone.....State.....



**NEW!  
TV-FM SWEEP  
GENERATOR &  
MARKER #368**

KIT \$69<sup>95</sup> WIRED \$119<sup>95</sup>

Entirely electronic sweep circuit (no mechanical devices) with accurately-biased inductor for excellent linearity. Extremely flat RF output: new AGC circuit automatically adjusts osc. for max. output on each band with min. ampl. variations. Exceptional tuning accuracy: edge-lit hairlines eliminate parallax. Swept Osc. Range 3-216 mc in 5 fund. bands. Variable Marker Range 2-75 mc in 3 fund. bands; 60-225 mc on harmonic band. 4.5 mc Xtal Marker Osc., xtal supplied. Ext. Marker provision. Sweep Width 0-3 mc lowest max. deviation to 0-30 mc highest max. dev. 2-way blanking. Narrow range phasing. Attenuators: Marker Size, RF Fine, RF Coarse (4-step decade). Cables: output, "scope horiz., "scope vertical. Deep-etched satin aluminum panel; rugged grey wrinkle steel cabinet.



**NEW!  
COLOR  
and Monochrome  
DC to 5 MC LAB & TV  
5" OSCILLOSCOPE  
#460**

KIT \$79<sup>95</sup> WIRED \$129<sup>50</sup>

• Features DC Amplifiers!

Flat from DC-4.5 mc, usable to 10 mc. VERT. AMPL.: sens. 25 rms mv/in; input Z 3 megs; direct-coupled & push-pull thruout; k-follower coupling bet. stages; 4-step freq-compensated attenuator up to 1000:1. SWEEP: perfectly linear 10 cps-100 kc (ext. cap. for range to 1 cps); pre-set TV V&H positions; auto. sync. ampl. & lim. PLUS: direct or cap. coupling; bal. or unbal. inputs; edge-lit engraved lucite graph screen; dimmer; filter; bezel fits std photo equipmt. High intensity trace CRT. 0.06 usec rise time. Push-pull hor. ampl., flat to 400 kc, sens. 0.6 rms mv/in. Built-in volt. calib. Z-axis mod. Sawtooth & 60 cps outputs. Astig. control. Retrace blanking. Phasing control.



**NEW! RF  
SIGNAL GENERATOR  
#324**

KIT \$26<sup>95</sup> WIRED \$39<sup>95</sup>

150 ke to 435 mc with ONE generator! Better value than generators selling at 2 or 3 times its cost! Ideal for IF-RF alignment, signal tracing & trouble-shooting of TV, FM, AM sets; marker gen.; 400 cps audio testing; lab. work. 6 fund. ranges: 150-400 ke, 400-1200 ke, 1.2-3.5 me, 3.5-11 me, 11-37 me, 37-145 mc; 1 harmonic band 111-435 mc. Freq. accurate to ±1.5%; 6:1 vernier tuning & excellent spread at most important alignment freqs. Etched tuning dial, plexiglass windows, edge-lit hairlines. Colpitts RF osc. directly plate-modulated by K-follower for improved mod. Variable depth of int. mod. 0-50% by 400 cps Colpitts osc. Variable gain ext. amplifier: only 3.0 v needed for 30% mod. Turret-mounted coils slug-tuned for max. accuracy. Fine & Coarse (3-step) RF attenuators. RF output 100,000 uv; AF sine wave output to 10 v. 50-ohm output Z. 5-way jack-top binding posts for AF in/out; coaxial connector & shielded cable for RF out. 12AU7, 12AV7, selenium rectifier; xmfr-operated. Deep-etched satin aluminum panel; rugged grey wrinkle steel cabinet.



**NEW! PEAK-to-PEAK  
VTVM #232 & UNI-  
PROBE (pat. pend.)**

KIT \$29<sup>95</sup> WIRED \$49<sup>95</sup>

Half-turn of probe tip selects DC or AC-Ohms.

Uni-Probe - exclusive with EICO - only 1 probe performs all functions!

Latest circuitry, high sensitivity & precision, wide ranges & versatility. Calibration without removing from cabinet. New balanced bridge circuit. High Z input for negligible loading. 4 1/2" meter, can't burn-out circuit. 7 non-skip ranges on every function. 4 functions: +DC Volts, -DC Volts, AC Volts, Ohms. Uniform 3 to 1 scale ratio for extreme wide-range accuracy. Zero center. One zero-adj. for all functions & ranges. 1% precision ceramic multiplier resistors. Measure directly peak-to-peak voltage of complex & sine waves: 0.4, 14, 42, 140, 420, 1400, 4200. DC/RMS sine volts: 0-1.5, 5, 15, 50, 150, 500, 1500 (up to 30,000 v. with HVP probe & 250 mc with PRF probe). Ohms: 0.2 ohms to 1000 megs. 12AU7, 6AL5, selenium rectifier; xmfr-operated. Deep-etched satin aluminum panel, rugged grey wrinkle steel cabinet.

TURN PAGE  
FOR MORE  
EICO VALUES



Send for  
**FREE CATALOG**  
now

Prices 5% higher on West Coast.

33-00 Northern Blvd., Long Island City 1, N. Y.

# TACTILE ELECTRONICS

... The Sense of Touch Can Be Conveyed From Afar ...

**T**HE direct extension of the first human sense—hearing—over appreciable distances began with the telephone in 1876. In 1926, John Logie Baird of London, England, added the second sense—sight—when television made its debut.\*

Remote perception of the third sense—touch—by *teletactility*—feeling at a distance—has been partly with us for some time. It is possible that Elisha Gray was the first to approach it with his *telautograph* (1888), which is still in use today. By means of the telautograph you can write at a distance, instantaneously, in your own handwriting. True, this is not transmitting actual touch at a distance, but it comes close to it. Some of the telautograph features may be used in future teletactile apparatus.

To understand better the problem of teletactility and its enormous future technical applications, we should first analyze its essentials. The tactile sense of touch or feeling means coming in contact with something—a sensation conveyed through the tactile nerves. These sensitive nerves are highly susceptible to pressure, variations of surface from polished to rough unevenness such as velvety, sticky, soft or hard, etc. In addition, the tactile nerves are sensitive to temperature.

While no single instrument—let us call it a *Teletac*—yet in existence can successfully feel at a distance, there is no reason in the world why it cannot be developed in the future. We have practically all the means at hand to bring it to life soon.

Indeed, for many years industry has had (and used) parts of the future Teletac. Let us cite a few. In paper manufacturing, electronic instruments continuously feel and check the thickness, smoothness (coating) of the paper in process of manufacture. The instruments alert the attendants if the paper runs uneven, or stop the machine automatically. For thin (tissue) papers, electronic contacting devices guard against small holes in the sheet. Similar instruments are used in the manufacture of rolled metal sheeting, such as nickel, copper, brass, tinfoils, etc. Devices of the same kind are used in the textile industry to control weaving machinery for smoothness in finishes, density, thickness (weight), etc., of the final cloth product.

In the printing industry, where high-speed presses require extra-fast output, the metal rollers are heated or other heating means are used to dry the inks rapidly on the running paper sheet as it issues from the press. Thermo-electronic devices maintain an exact optimum temperature while the press runs.

In rubber manufacture, special electronically rigged rollers check the correct softness or hardness of rubber stock. Here, too, the electronic sensing device stops the machinery if the end product is too hard or too soft.

A recent sensing device, called the *proximity limit switch*, uses a special transducer. The entire instrument, less than 2 x 6 inches, is actuated, by the presence of magnetic materials, over a wide range of shapes, sizes, weights, roughness, whether at rest or speeding. The sensing head requires no physical contact and is effective up to a 1-inch distance. It has no moving parts and has many industrial uses.

The *Physiophone* of the author, first demonstrated in 1920 at the New York Institute for the Deaf, transformed sound waves into high-frequency electric waves. These were then conveyed via hand electrodes to the deaf. The sound was felt

as pleasant, slight tingling shocks. By holding hands a group of totally deaf persons could simultaneously “hear” music, speeches, etc.

Of interest also was a later electric instrument called *teletactor* used by the deaf. It converts sound waves into vibrations which are detected by the finger tips.

But let us now consider the comprehensive Teletac, a future instrument with which you can actually feel at a distance. The complex transmitter—not necessarily large—could then be plugged into any telephone which by that time will also be color-television equipped. You could then see, feel and order a suit or a bolt of cloth or any other merchandise across the continent. Fantastic? Yes, but not impossible. The sales clerk upon request would run his Teletac over the goods and you could actually feel the texture at a distance. Your Teletac receiver, an integral part of your own phone, requires that you merely insert your finger into its opening. Instantly you will feel the fabric and you will distinguish between silk, velvet, wool or linen. A doctor, too, can in this manner feel a patient's pulse, take his temperature, etc.

How can this be done? At the transmitter we have a metallic sensing “brush.” Its smooth, round “bristles” are of metal. The short bristles, very close together, are mounted on a sort of telephone diaphragm with an electromagnet under the diaphragm making the device act similarly to a telephone. Moving the bristles over a rough texture vibrates the diaphragm more than a smooth surface. By amplification the receiver diaphragm is displaced exactly as the one at the transmitter. The receiver has a similar diaphragm with bristles on which your finger rests. You now have the illusion of feeling the exact consistency of the texture at the far transmitter. Your finger is at rest, but *the bristles have the motion*, acting as if you moved the finger over the distant material—which is what actually occurs. This is of course only one way to accomplish teletactility. There are many other and more refined ways.

At the transmitter a thermistor surrounds the bristles at the same level as their tops but does not touch the bristles. When the ring touches any material—or the human body, for instance—the thermistor transmits an electric impulse over the line. At the receiver this impulse—amplified—heats a similarly shaped heater rim. Hence your finger senses the same degree of heat as that existing at the transmitter. A doctor can thus place a thermometer in the Teletac receiver and read the patient's temperature, provided the patient had a Teletac transmitter.

This is only a *very* sketchy and incomplete description of such a device without future refinements. For the immediate future and for industrial purposes, the problem is much simpler.

For oil-well drilling, for instance, the sensing organ can be quite rugged to tell the men instantly in what type of strata the drill head is biting. Pyrometers for heat interpretation at a distance are already on the market.

One interesting, noncommercial Teletac could easily be adapted for the blind. Braille books, using elevated dots for tactile reading are expensive. In the future, one monitoring person could guide a transmitter over the pages of a single book. Innumerable blind individuals could then simultaneously feel—read such a braille broadcast at small cost.

Industry has thousands of uses for various electronic teletacs. Few will be alike, as every manufacturing plant has its own special conditions. Yet one thing is certain: electronics will be able to supply *any* type of Teletac required to feel and sense efficiently at a distance.

—H.G.

\* Paul Nipkow in Berlin was first with the invention of the scanning disk, in 1884, but no fast, light-sensitive photoelectric cells were then in existence. Hence he never achieved true television.

# Two new approaches to

# AMPLIFICATION

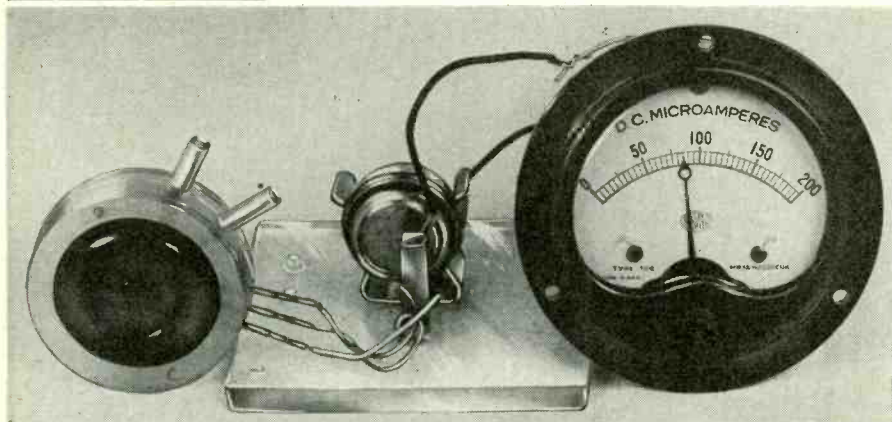

*New semiconductor and electrolytic devices may push ultra-high-frequency limits upward; far outdo transistors in circuitry simplification and compactness*

By ERIC LESLIE

(Top) Spacistor Collector vertical rod at bottom right; base, rod slanting to bottom left; injector, left slanting cat-whisker; modulator, one at right.

(Bottom) Solion (left) with special 0.9-volt battery (center) and an indicating meter, as used to measure moderate sound pressures.

**W**ITHIN the past few months two new amplifying devices have appeared in the field where for so many years de Forest's electron tube ruled alone, moving aside a little only in the past decade to permit the transistor to do some of its jobs.

One of the new devices, Raytheon's Spacistor (RADIO-ELECTRONICS, September, 1957, page 8) looks like a member of the transistor family. The other, the Naval Ordnance Laboratory's Solion (rhymes with Napoleon) ("Electrochemical Units," RADIO-ELECTRONICS, August, 1957, page 12), is like nothing else in this world. A flat cylindrical cell, which may be less than 2 inches across, divided or partly divided into two sections and filled with an electrolyte, it is a closer relative to the old wet cells that used to operate doorbells than to anything now used in the electric-electronic field. Yet it can measure pressures, flows, accelerations, and performs other functions which would otherwise require expensive, complex and bulky equipment. Operating on just under 1 volt, it runs for such long periods of time on an electric cell (battery XA-10B) specially constructed for it as to make even the transistor look like a current hog.

Neither of these devices has reached the commercial market, and it is still too early to predict what part they will play in an electronic world where the tube and transistor have already

proved themselves practical and versatile amplifiers. The Spacistor is expected to find its most useful applications in the uhf field; the Solion is limited to a top of 400 cycles at present, but can operate from there down to dc. It can also be used as a transducer to turn electric into mechanical energy.

The very name of the Spacistor puts it in the solid-state amplifier family, whose best known member is the transistor. But this semiconductor device acts in many ways more like a vacuum tube than a transistor. (See Fig. 1.)

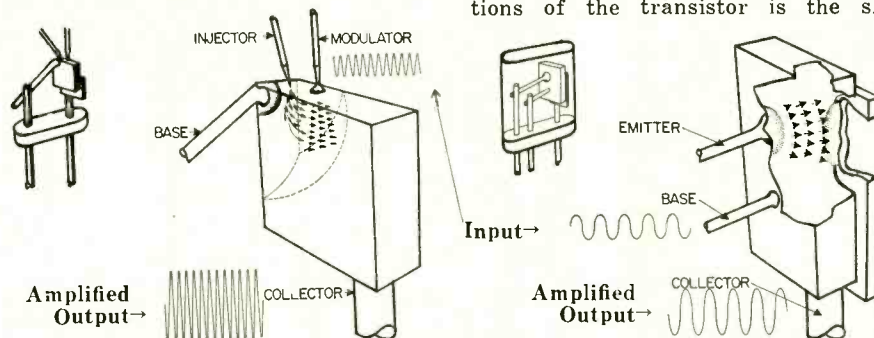

Fig. 1—Two amplifiers compared. **Spacistor**—High voltage is applied between collector and base in direction to produce strong electric field and practically no current. Electrons injected into this field flow very rapidly to collector. Flow is modulated by signal applied between base and modulator, which acts like vacuum-tube grid. **Transistor**—Similar but lower voltage is applied between collector and base. Since emitter (in n-p-n transistor) is more negative than base area near it, it injects electrons, which flow to positive collector (at lower speed than in the Spacistor, because of lower collector voltage). Signal to be amplified is applied between base and emitter, current from which increases and decreases as it becomes more or less negative with respect to base. Action is same in p-n-p transistor, with reversal of voltages and current flow.

The Spacistor operates at 100 volts; transistors are commonly low-voltage devices. Transistor output and input impedances are low; those of the Spacistor are high, even higher than for vacuum tubes. Transistor input capacitances, conversely, are high; the Spacistor's lower than those of vacuum tubes.

The transistor's most serious limitation has been frequency. Readers remember when commonly available ones would work well over only a little more than the audio range. The frequency limit has been pushed steadily upward since that time, but is still well below that of vacuum tubes.

One reason for the frequency limitations of the transistor is the slow



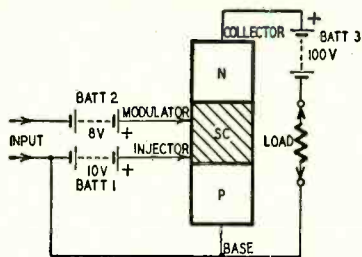

Fig. 2—Idealized cross section of an experimental Spacistor.

diffusion of charge carriers (electrons or holes) through the base region. The applied voltages are usually low, and little push is applied to the charge carriers. Therefore, they move at a relatively low speed and when faced with rapid alternations of signal current just can't get to their destinations rapidly enough to produce an output exactly mirroring that of the input. In the language of the scientists, the electric field in which they move doesn't give them enough acceleration.

A vacuum tube—with a drop of usually more than 100 volts between cathode and plate—has a strong field, and electrons are hurried right along in it. The same is true of the Spacistor, where 100 volts is applied across the body of the semiconductor, between collector and base in Fig. 2.

The unit is a p-n junction hooked up in reverse bias (the direction that opposes current flow). Thus, there is a sharp potential gradient throughout the Spacistor, and we find a heavy space charge somewhat like that in a vacuum tube. This charge exists to some extent throughout the semiconductor, but is much heavier in the area marked SC. In this area particularly, moving charges are speeded by high voltage across the Spacistor body.

So the problem of speeding up the charge carriers is solved. All that remains now is to get some charge carriers to speed up. We also have to control our stream of charges so as to get amplifier action. The tungsten-wire contact marked INJECTOR supplies the charges. It is connected to the base through a battery (BATT 1) which biases it slightly more negative than that part of the base with which it is in contact. Therefore it emits electrons into SC, the space charge area. The flow of electrons from the injector is limited by the backward pressure of the space charge, as in a vacuum tube.

The MODULATOR is placed a little farther along the body of the Spacistor and is also biased (with BATT 2) to be somewhat more negative than the area under it. But it is doped with a little p-type material, and thus forms a p-n junction with the underlying semiconductor. Since its bias is negative, it can emit no holes into the base and therefore draws no current.

The input signal is applied between the modulator and the base. The modulator acts like the grid of a vacuum tube; changes of voltage on it vary the current from the injector. The dc

bias voltage on the modulator also makes it act something like the screen grid in a vacuum tube. The field due to this voltage is felt through the whole space-charge region and has a greater effect on the no-signal current from the injector than does the voltage from BATT 3, across the whole Spacistor. Thus it tends to prevent the injector current from being affected by changes in the voltage between base and collector. This keeps the output impedance reasonably high—in excess of 30 megohms for an injected current of 30 ma. (The input impedance is likewise high—also about 30 megohms.)

The Spacistor is still in the early experimental stages and has not yet been tested to the limits of its capabilities. No checks at very- or ultra-high frequencies have been run, and the full amplifying power of the device is still unknown. Low-frequency power gains of 70 db and voltage gains of 3,000 have already been obtained from experimental units. Transconductance of present Spacistors is considerably below that of good vacuum tubes, but is comparable to that of dry-cell types.

The Spacistor's output capacitance is extremely low—values of less than 1  $\mu\text{mf}$  are entirely feasible—and it is expected that amplifiers can be built to operate at frequencies higher than 1,000 mc. Another advantage of the Spacistor is the isolation of input and output circuits by the modulator's screening action—a valuable feature in multistage circuits. It is further expected that it will be possible to construct Spacistors from much higher-temperature materials than transistors.

### The ionization cell

Many of us were given some idea of ionic action in our student days. In practical life, the flow of electrons has so far overshadowed that of ions that we may have forgotten that ions can carry current as well as electrons. Yet the ion still does play its part in our everyday life. It does useful work in gas tubes, like mercury-vapor rectifiers, thyratrons and voltage regulators, and is even more common in electrolytic capacitors, where ions actually form one of the plates. A more conspicuous (but less useful!) form of ionic activity

is corona discharge, ever more familiar with increasing voltages on TV tubes.

Ionization is the breaking down of atoms under electric stress. An atom so broken down may lose an electron, and be dissociated into a negative electron and a *positive ion*. Or it may gain an electron and become a *negative ion*.

An ion, then, is a charged particle of matter—an atom that has gained or lost one or more electrons.

Ions may be made by collision. In a mercury-vapor rectifier or thyatron, electrons on their way from cathode to anode knock electrons out of the gas atoms they run into on the way. These electrons accompany the first ones to the plate, increasing the tube's current output.

Ions may also be made chemically. *Electrolytes* are chemical solutions whose constituents may be ionized. A very common example of such ionization is the electric primary cell (a flashlight battery is the most common example). Chemical action dissolves zinc atoms out of the can. They leave in the form of positive ions, leaving electrons behind them, and unite with negative ions of chlorine to form zinc chloride. Energy is released by this chemical reaction; electrons piled up in the zinc electrode (the can) constitute a negative voltage and can be made to do work on their way back to the positive (carbon) electrode.

In some types of electrolytic cells we may put an external source of electricity across the electrodes instead of expecting energy from the cell itself. (The electrolytic capacitor again comes immediately to mind.) A cell with two electrodes of the same metal and an electrolyte composed of a salt of that metal can be used in electroplating. Atoms go into solution as positive ions at the positive electrode, each atom leaving an electron behind. These ions drift toward the negative electrode, where each one picks up its missing electron and again becomes an atom of the metal. (If the negative electrode is not of the same metal as the positive one, it will be *plated* with metal from it.)

### The Solion

A third type of electrolytic cell—the one used in the Solion—is one in which the electrodes take no part in the action. A typical Solion has platinum electrodes and a mixture of iodine molecules and potassium iodide in solution. The potassium iodide breaks up into positive potassium and negative iodide ions. The iodine molecules, drifting to the negative electrode at a rate virtually independent of the low voltage which is applied to the Solion, acquire electrons and become negative iodide ions. These ions move to the positive electrode, give up their electrons, again become iodine molecules.

The quantity of electric current that will flow is controlled by the rate at which iodine molecules are broken down into iodide ions at the cathode

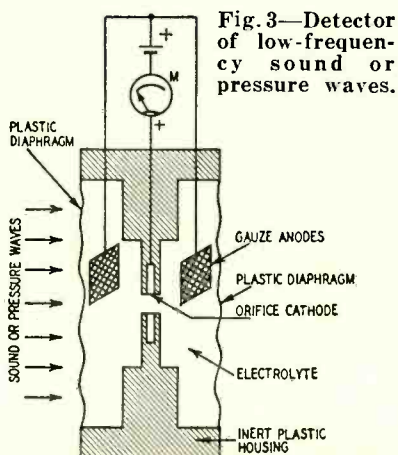

Fig. 3—Detector of low-frequency sound or pressure waves.

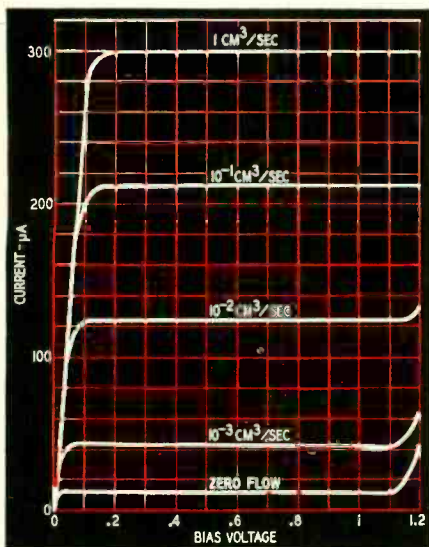

Fig. 4—Response of cell of Fig. 3 as signal is increased.

(negative electrode) rather than by their re-formation into iodine molecules at the positive electrode. Hence the current flow is independent of voltage and depends on factors such as stirring (movement of solution past the cathode).

Thus we can use mechanical energy (stirring) to regulate electrical energy or convert mechanical energy to electrical energy. The first application of such an effect that comes to mind is a flow meter, and the Solion can be used for that purpose.

Fig. 3 is an example of a flow meter. This is a typical Solion used as an acoustic detector (in other words, as a sort of microphone).

At the orifice cathode, iodine is changed to iodide ions. At the gauze anodes, iodide ions are reconverted to iodine molecules. The number of iodine molecules coming into contact with the orifice cathode controls the flow of electric current in the solution.

When there is a flow of electrolyte through the cathode orifice, the number of iodine molecules coming into contact with the cathode is greater than when the liquid is still. Sound waves striking the diaphragm at the left (Fig. 3) exert pressure on the liquid, causing it to flow back and forth through the orifice in proportion to the intensity of the sound. The meter indicates current changes accordingly.

The peculiar shape of the cathode is due to the response desired. A cathode so constructed will have roughly a logarithmic response, as indicated by Fig. 4. A cell of the type shown in Fig. 3 may pass a current of less than 20 μa with no flow of liquid through the cathode orifice. At .001 cubic centimeter (cc) per second the current increases to more than 40 μa, an easily measurable difference. At 1.0 cc per second, current is more than 300 μa.

The same type of cell may be used to indicate and measure low-frequency changes of pressure that would not be called sound waves. Results are particularly good between 2 and 10 cycles,

though the cell can be designed to increase response at a desired frequency (resonate) and is useful up to a top limit of about 400 cycles with present designs.

The "separated detector"

The Solion principle may be used in a variety of modified designs for special jobs. An example of a slightly different type of Solion is that in Fig. 5. It is adapted to the measurement of unidirectional flows and pressures. The hookup resembles that of Fig. 3, except that one of the outside electrodes is at the same voltage as the cathode, which in this cell is a piece of closely woven platinum gauze. (Its response is linear rather than logarithmic.) The ions tend to drift toward the left (positive) electrode (anode) where they become iodine molecules. In time, practically all the iodine ions find themselves, under the attraction of the anode, on the left side of the cathode (separator electrode). Now, if there is a movement of liquid toward the right, due to pressure on the left diaphragm, new ions are brought into contact with the cathode, and increased current flow is indicated on the meter. If flow is from right to left, there is no action—there are practically no iodine ions in the liquid in the cell's right section.

The electro-osmotic cell

The Solion is a two-way transducer—it can act as a flow meter which converts mechanical energy to electrical energy, and as a pump which converts electrical energy to mechanical energy. This pump can be made without moving parts by using *electro-osmosis*.

An electro-osmotic pump is shown in Fig. 6. It has long been known that when a liquid of low conductivity is placed in a tube of—for instance—glass, the inside surface of the tube takes on an excess negative charge. The solution close to this surface has an excess positive charge, its atoms having lost electrons to the glass. The great majority of these positive ions are tightly bound to the surface and are not free to move. Further out, they are freer to move, though they are also less numerous.

If a voltage is applied to electrodes at the ends of the tubes, as shown in Fig. 6, these ions start to move to the left, taking other molecules with them.

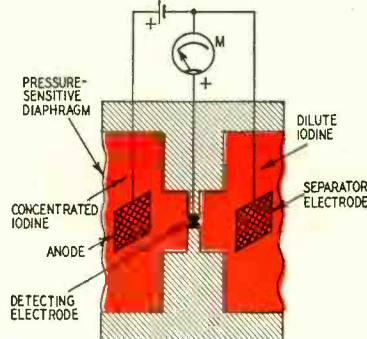

Fig. 5—Separated detector measures unidirectional liquid motion; acts as rectifier on back-and-forth flows.

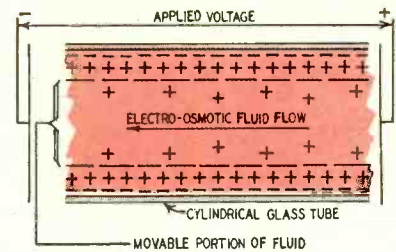

Fig. 6—How an electro-osmotic flow is produced.

The solution is literally "dragged by its skin" through the tube. The rate of flow can be varied by varying the voltage applied across the ends of the tube.

In the "pump" used in some Solion devices, the narrow tube is replaced by a porous disc which is essentially an arrangement of thousands of extremely small tubes. The electrodes are placed on the flat surfaces of the disc and thus liquid is forced from one side of it to the other.

An example of an electro-osmotic cell is shown in Fig. 7. It uses distilled water as a low-conductivity fluid, and the flow of liquid can be made linear with the applied voltage.

Such a cell may be combined with the separated detector of Fig. 5 to form an amplifier. A typical example is an electro-osmotic cell with 1 volt applied across it. The current can be held to about 30 μa, a power input of 30 microwatts. A linear separated detector hydraulically coupled to the electro-osmotic cell can be designed to give an output of 10 ma across 100 ohms. This is 10 milliwatts out for 30 microwatts in, a power gain of 330.

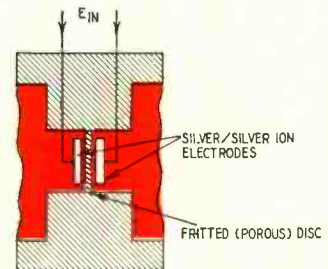

Fig. 7—Voltage applied to electro-osmotic cell produces liquid flow.

The possibilities of the Solion are by no means limited to the types described above. Other designs for special purposes or for obtaining outputs bearing a special mathematical relation to the input have been designed. But even those already described seem to have a wider range of applications than can at present be predicted or imagined. They are expected to be particularly useful in airplane instrumentation. Three of them coupled together, according to the Naval Ordnance Laboratory, can be used to show directional changes in the three dimensions through which an airplane flies, replacing hundreds of pounds of bulky equipment with three extremely simple, compact units whose weight is measured in ounces. The same compactness and simplicity are likely to open up many applications in industrial and other fields. END

# ... more about transistor types ...

*Part I—How drift and Unijunction transistors work and a discussion on the manufacture of alloy and diffusion transistors*

By PAUL PENFIELD, JR.

IN October and November, 1956, I attempted to clarify some of the confusion which was inevitable as a result of the barrage of numerous types of transistors, many with very strange-sounding names. Within the past year some new transistor types have appeared, specifically RCA's Drift transistor and G-E's Unijunction. In addition, there has been some recent confusion about the effects of various manufacturing methods on transistor properties. Therefore, it seems appropriate to go over this question.

### Drift transistors

The major limit on high-frequency response of junction transistors is the time it takes holes (for p-n-p transistors) to wander or diffuse across the base. Inside the base region there is no electric field, and the only reason why the holes travel across at all is that there are more of them near the emitter and they tend to spread out evenly.

There are three main ways to get around this effect. One is to make the base extremely thin (as in surface-barrier or micro-alloy transistors). Another is to devise a structure which does not have any current carriers diffusing, and restricts the flow of carriers directly instead (the field-effect transistor). A third way is to build an electric field in the base of an ordinary junction transistor to make the holes scoot across faster. When holes are acted on by an electric field they drift much faster than they would otherwise diffuse. The p-n-i-p transistor ("Confused About Transistor Types, Part I," RADIO-ELECTRONICS, October, 1956) has such a built-in electric field, but it is not as efficient as the one in the drift transistor.

The built-in electric field is produced by having a difference in the number of donor atoms distributed in various parts of the base. Near the emitter there are more than near the collector. The "why" is not obvious but, if properly done, this graded-impurity base

Fig. 4—Diffused E-C transistor. Special masks control the area of diffusion.

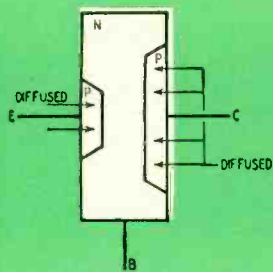

Fig. 5—Alloy-diffused transistor uses best features of alloy and diffused techniques to make a good drift transistor.

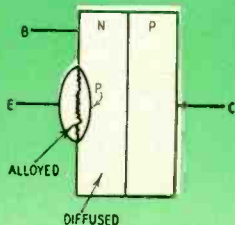

Fig. 6—Normal construction of drift transistor. Fourth lead is often added to provide shielding.

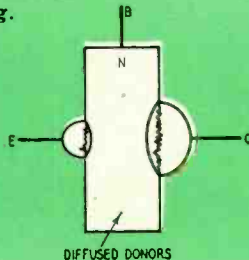

Fig. 7—Steps in making a double-diffused transistor.

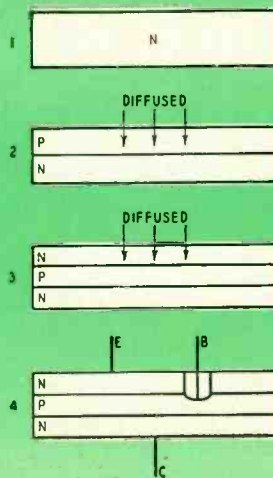

Fig. 1—Unijunction transistor has one junction, three leads.

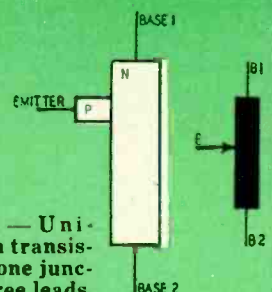

Fig. 2—Steps in making an alloy transistor.

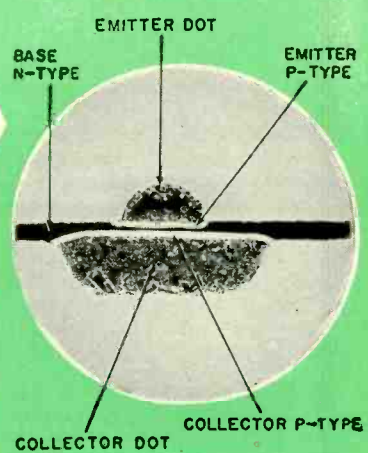
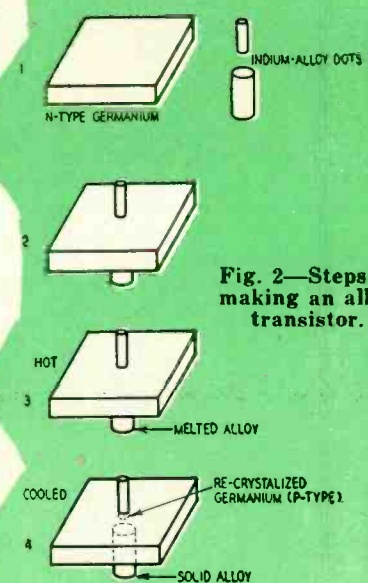

Fig. 3—Cross-section photograph of an alloy transistor. Note that the junctions are parallel. (Photo courtesy Raytheon Mfg. Co.)

## ELECTRONICS

produces an electric field which is in the proper direction to help holes cross rapidly to the collector.

The drift transistor is also called a diffused-base transistor because this describes the way the impurities are placed in the base. However, in operation, drift by electric field, not diffusion, is the method used for getting the holes across the base. Do not be confused by these terms.

This arrangement also leads to a small collector capacitance and a low base resistance—both desirable effects for high-frequency operation. Because of these factors the drift transistor can operate in the tens of megacycles.

### The Unijunction

Formerly known as the double-base diode, this device (shown in Fig. 1) has only one junction but two base contacts. (See "Using the Unijunction" RADIO-ELECTRONICS, July, 1957.) If it had an additional collector region on the right, it would be just like a tetrode transistor.

In operation, a steady current is passed between the two base electrodes, and the point where the emitter is located is at some voltage above base 2. As the emitter contact's potential is raised, nothing much happens until it reaches the potential of the base region directly opposite it. At this point the junction at the emitter becomes forward biased, and the current flows in.

The interesting thing is that as soon as the emitter junction passes current, the effective base-to-base resistance drops considerably because of the holes which the emitter passes into the base. Once this happens, the point in the base near the emitter junction will drop in voltage, causing the emitter to be even more forward biased, causing more emitter current, etc. This is an unstable condition, and the current would run away if it were not limited by external resistors. The device is now in a low-voltage high-current condition and is effectively on whereas before it was off.

The Unijunction transistor is not useful as an amplifier, but is good for switching circuits, multivibrators, etc. It has been compared to the thyatron because its firing action is similar.

### Transistor differences

Two transistors may be different, and therefore be given different names, for a number of reasons. They may be different types or they may be made from different materials—germanium, silicon or some other semiconductor.

Generally speaking, silicon is better at higher power levels and germanium at higher frequencies. In the future, one of the dozens of uninvestigated semi-conductors may turn out to be better transistor material than either germanium or silicon.

But an important third difference may be the method of manufacture. Junction transistors, for example, can

be made many ways, and the transistor's characteristics depend on the method used.

In making transistors the idea is to make two p-n junctions close together. Remember that a p-region is formed wherever the acceptor density is greater than the number of donor impurities, and n-type material has more donors than acceptors. Methods of making transistors depend on schemes to move impurity atoms about and change their density.

Four such schemes are important. One is crystal-growing with controlled amounts of impurities. Another is melting a piece of germanium and letting it refreeze (recrystallize). The third is a diffusion operation conducted at moderately high temperatures, and last comes the very important alloy technique. Many manufacturing methods use more than one of these four techniques.

*Alloy transistors\** are by far the most common, especially for everyday applications and for power transistors. Here we start off with, say, an n-type chip of germanium (see Fig. 2) and place small dots of indium-gallium-silver alloy on it. Upon heating, this alloy melts and dissolves some of the germanium. When the temperature is lowered, the germanium nearest the n-type germanium refreezes to form a single crystal, but heavily doped with gallium, which is an acceptor. Thus this region will be p-type.

In practice, two dots are placed on the chip of germanium simultaneously, one to be the collector and one the emitter. Fig. 3 is a microphotograph of a cross-section view of a completed structure. Special techniques were used to make the p-type regions, emitter and collector, appear white. Contact is made by soldering a wire onto the two dots and making an ohmic contact to the base region.

This method is simple and cheap and gives nearly 100% yield when done with care. Unfortunately it is not easy to control the base width accurately, so alloy transistors are not too good for high frequencies.

Silicon p-n-p and n-p-n alloy transistors are possible, as are germanium n-p-n models, but in each of these cases there are still unsolved problems.

### Diffusion types

Impurity atoms such as donors and acceptors can diffuse through solid germanium at moderately high temperatures just as a drop of ink will slowly diffuse through a glass of still water. The rate at which they diffuse depends on the temperature and also on the material.

Diffusion can take place from plated electrodes made of the diffusing material or from a vapor of the material.

\* Also known as alloy-junction, alloyed, fused-junction, fusion-alloy, diffused-alloyed, fused-alloy, and formerly known as diffused-junction, alloy-diffusion and diffused transistors. Do not be confused because of the many names, some of which are close to or the same as names for different manufacturing methods.

If doped material is heated in a vacuum, impurities will diffuse out from the surfaces.

Diffusion is a very versatile technique for moving impurities to form junctions, although not enough information is yet available about it. The temperature applied is moderate so the germanium does not melt, and the time required is measured in minutes so the process can be controlled fairly accurately.

Often, diffusion will occur in making other types of transistors, and it is not really known what role diffusion has in making alloy transistors. Because it is not easy to tell which mechanism is at work, alloy transistors used to be called diffusion transistors.

A *diffused emitter-collector* (or *diffused E-C transistor*) is made by diffusing in acceptor impurities on two sides of a thin slab of n-type material (see Fig. 4) to form two junctions. The device looks much like an alloy transistor.

An additional step is required to make contact to the p-regions, raising the cost slightly, but an advantage is that for power transistors the heat sink can be attached much closer to the collector junction. This type of construction is best suited for silicon and germanium power transistors. Both p-n-p and n-p-n transistors can be made.

An *alloy-diffused* (or *diffused-base*) transistor is made by diffusing an n-type layer on the surface of a p-type crystal. This n-layer becomes the base (as shown in Fig. 5) and the original crystal the collector. A p-type emitter is alloyed in on the top surface.

This technique is rather easy with germanium and gives a donor distribution in the base which makes the completed unit a drift transistor, not a normal junction transistor.

Alternatively, the original material could be intrinsic or slightly n-type, and both the emitter and the collector could be alloyed after the diffusion process. Fig. 6 shows the construction, which is used in commercial drift transistors.

*Double-diffused transistors*, still not commercially available, are quite practical for silicon. Here two diffusions are used, in the order indicated in Fig. 7. First a p-layer is diffused as the base and then on top of this, at a lower temperature, an n-layer is diffused on as the emitter.

There are several undesirable features about the double-diffused transistor, such as the necessity to drill a hole through the emitter region to make connection to the base. However at present this technique is one of the most promising for high-frequency silicon transistors.

Next month we will continue with this discussion of manufacturing methods. Bonded, micro-alloy, grown-junction, rate-grown, grown-diffused and melt-back transistors will be covered.

TO BE CONTINUED

Protect your transistors  
with circuit breakers

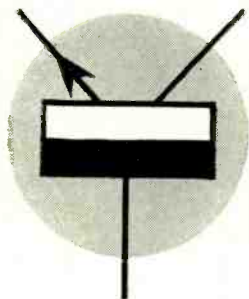

# TRANSISTOR CIRCUIT BREAKERS

By A. H. TAYLOR

**T**RANSISTORS need protection against mistakes in any circuit, but especially in class-B amplifiers. Fuses are simplest but their cost tempts you to fuse too heavily and their resistance makes trouble in low-impedance circuits.

You can make a circuit breaker that has lower resistance than a fuse from a transistor and a relay. It will soon pay for itself. The principle is very simple and is also good for using cheap, high-resistance meters in circuits which will not tolerate their resistance. Place a low resistance (R1) in series with the load and apply the drop across it to the emitter and base of a transistor as in Fig. 1. Put the relay coil (or meter) in series between the collector and the battery.

It makes no difference whether the battery returns to the base as in Figs. 1-a and -b or to the emitter as in Fig. 1-c, if the resistance of R1 is much lower than the common-base input resistance of the transistor. Very high alpha is no advantage but a low-current relay and a transistor with low input resistance make a circuit breaker with lower series resistance. Coil resistance up to about 10,000 ohms has no effect but to require a higher voltage. The battery supply (Ea) must be a volt or two more than the relay requires (operating current times coil resistance) but less than the transistor's maximum rating. Keep it as low as possible.

Voltage can be lowest in Fig. 1-a because the polarized relay has less resistance for the same operating current. The unbiased tongue remains tripped without battery drain and is reset by hand or reverse current. Capacitor C makes the breaker trip instead of just buzzing and can be larger if a delay is wanted.

Circuits in Figs. 1-b and 1-c use ordinary plate-circuit relays which operate with a few ma in coils of 2,500-10,000 ohms and are connected to hold on after tripping until reset. They do not need capacitor C if they make before they break, but with make-before-break contacts switch S1 is needed in Fig. 1-b to protect the transistor

during switching. A large value for capacitor C delays tripping.

## Three-terminal breaker

The breakers of Fig. 1 have only two terminals and can be used anywhere like a fuse. Fig. 2 shows the circuit of a compact three-terminal breaker which uses the battery of the protected circuit. It requires a p-n-p transistor if it breaks

the positive lead and a n-p-n transistor and reversed electrolytics if it breaks the negative lead. The photos show construction details of the unit.

The sensitive relay in this breaker keys a huskier one with better contacts. There should be several contacts, but the relay that fits the box doesn't have them. Besides, it is better to use independent breakers with circuits that have more than two battery leads.

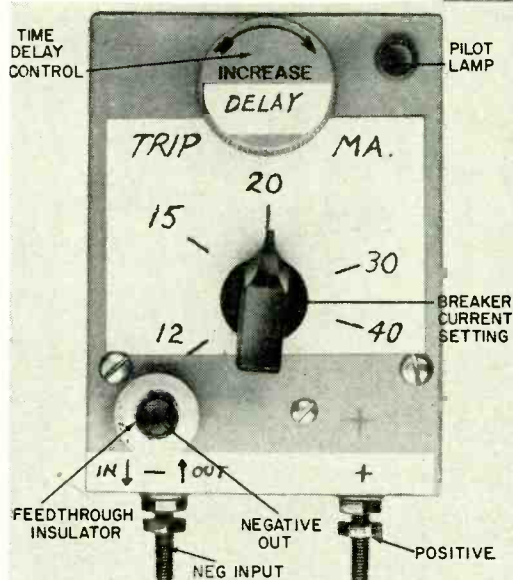

A compact three-terminal breaker opens the negative lead.

Construction of three-terminal circuit breaker.

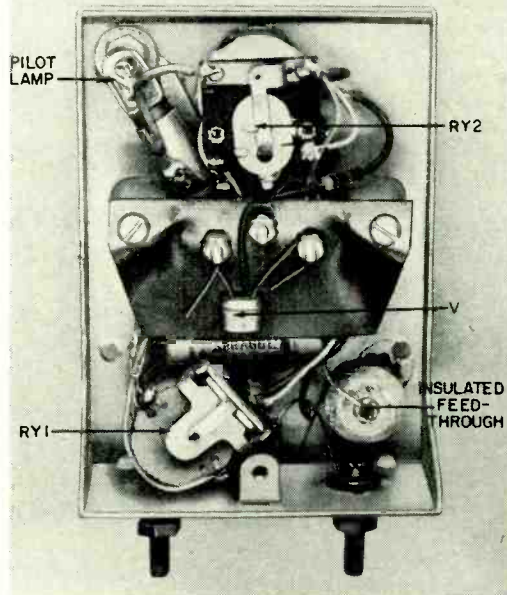

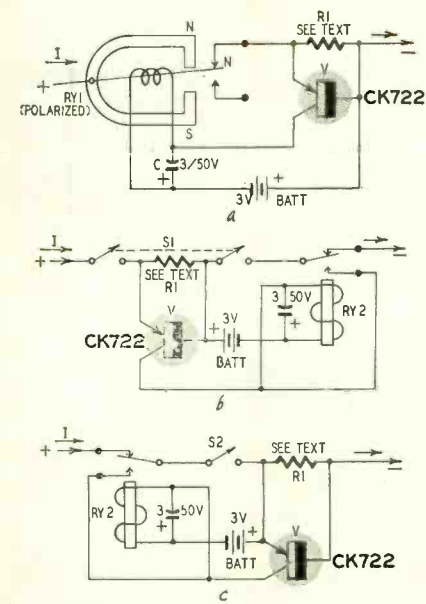

- R1—see text
- C—3  $\mu$ f, 50 volts
- Ry 1—polarized relay, 500-ohm coil
- Ry 2—nonpolar relay, 2,500 to 10,000 ohms
- S1—dpst toggle
- S2—spst toggle
- V—CK722
- Battery—3–22.5 volts

Fig. 1—Three basic circuit breakers.

A pilot light indicates that the breaker has been tripped and, if it burns out, the current through R1 holds the relay without it. The 75 ma drawn by the relay doesn't kill the battery if it is shut off promptly. Ry1 could be a latching relay that holds mechanically instead of electrically, but it would be bigger and cost more.

Tripping current and delay are continuously adjustable. C2 delays the tripping longer as R4 is decreased (it can have any one of a wide range of values) and C1 can be omitted if Ry1 makes

before it breaks. C1 causes no delay because it is charged directly from the battery through R2, which prevents contact pitting. Where there is chance of accidentally reversing polarity, C1 and C2 should each consist of two capacitors in series back to back, to trip the breaker instead of damaging the transistor or the capacitors. Some electrolytics do seem to work at low voltage with either polarity. To use this breaker with higher currents, just make R3 lower and F1 heavier.

A circuit breaker not only protects the transistors but also warns of amplifier clipping when set to the known overload point and not delayed. It trips on peaks which a milliammeter does not show but which distort the output.

Multistage breakers

Amplification increases the sensitivity, which means lower resistance. You can add alternate p-n-p and n-p-n stages to the simple dc amplifier of Fig. 3 until the amplified cutoff current trips the relay or temperature has too much effect. The gain is low because the first stage operates near cutoff. Bridge circuits would be better and stabler.

All these breakers need protection against dead shorts. Put a fast fuse heavy enough for negligible resistance in series, and preferably a light fuse in the base lead as in Fig. 2. A 10-ma fuse (263 ohms) cuts the sensitivity of a CK722 or a 2N97 about one-third, so use a 1/32-amp 8AG, whose 40 ohms have little effect. Even a resistor of this size might save the transistor till the other fuse can blow. The relay coil resistance protects the transistor's collector circuit.

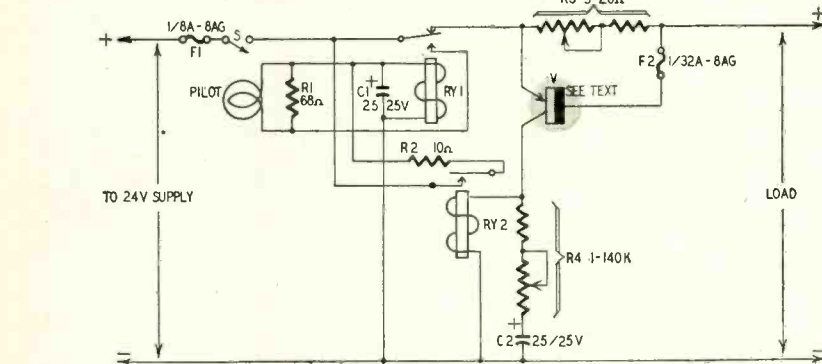

- R1—68 ohms, 1/2 watt
- R2—10 ohms, 1/2 watt
- R3—5–20 ohms, 1/2 watt
- R4—1,000–140,000 ohms, 1/2 watt
- C1, C2—25- $\mu$ f 25-volt electrolytic
- F1—1/8 amp, 8AG
- F2—1/32 amp, 8AG
- Ry1—spdt, normally open, 6,500 ohms, closes on 3 ma dc with 22.5-volt battery
- Ry2—spst, 320 ohms, 75 ma on 24 volts dc
- S—spst toggle
- V—CK722, 2N107 for breaking positive lead (see text); 2N97, 2N229 for breaking negative lead (see text)

Fig. 2—A three-terminal circuit breaker to open positive lead.

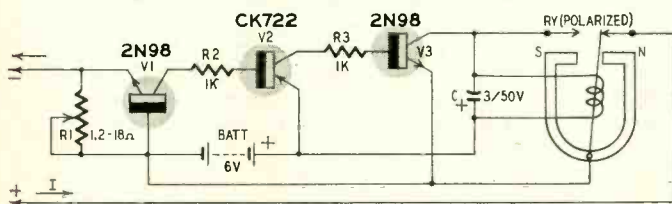

- R1—1.2–18 ohms
- R2, 3—1,000 ohms, 1/2 watt
- C—3  $\mu$ f, 50 volts
- Ry—polarized relay, 500-ohm coil
- V1, V3—2N98
- V2—CK722

Fig. 3—A multistage circuit breaker.

MULTIPLE SUN BATTERY

By RUFUS P. TURNER

THE dc output of an inexpensive sun battery is too low for most amateur and experimental applications such as supplying the bias for transistor circuits. However, more current or voltage can be obtained by connecting several of these cells in parallel or series.

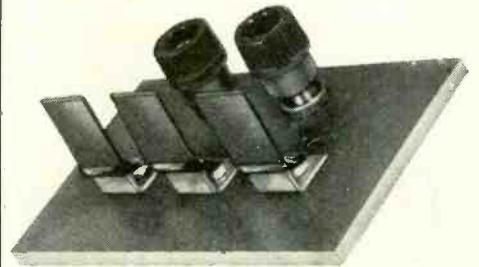

Completed sun battery.

Readers have several times expressed curiosity as to the performance of a battery of these cells and we decided to make a test to determine the output characteristics. First, it was figured that three cells would be about the largest number the average experimenter would buy. So three International Rectifier Corp. type B2M cells were mounted and connected as shown in the photo and Fig. 1.

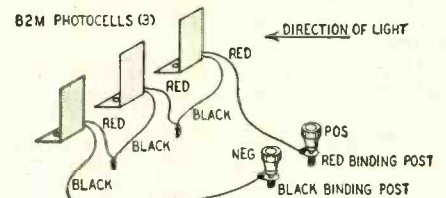

Fig. 1—Pictorial of wiring.

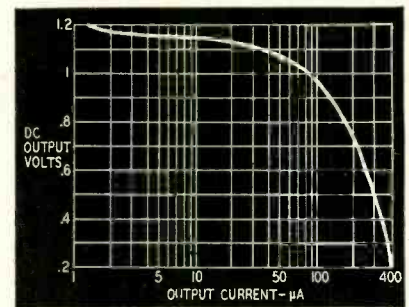

Fig. 2—Output of multiple sun battery.

Fig. 2 shows the dc output characteristic of this three-cell sun battery when exposed to direct sunlight. Note from this curve that the output varies from 1.2 volts at 1.2- $\mu$ a load (external resistance  $R_L = 1$  megohm) to 0.2 volt at 400  $\mu$ a ( $R_L = 500$  ohms). The dc output will be proportionately lower in dimmer light. In the 100–400- $\mu$ a region, in which most transistor operation probably will occur, there is a variation from 0.2 to 0.97 volt.



# HIGH FIDELITY

at **LOW COST...** with

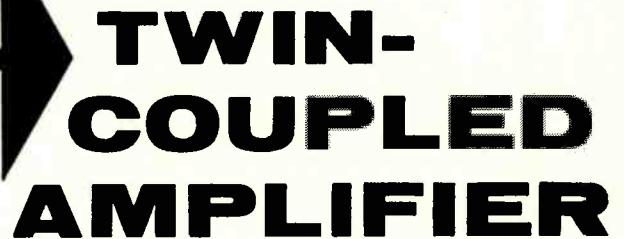

## TWIN-COUPLED AMPLIFIER

By **NORMAN H. CROWHURST**

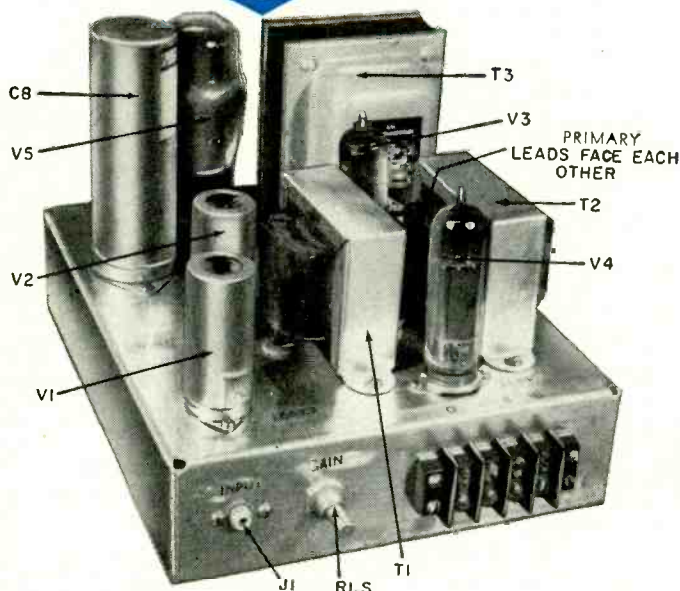

Twin-coupled high-fidelity amplifier delivers 15 watts.

*In this new circuit reproduction is improved by using two output transformers—without pushing up the price*

need a very good output transformer designed specifically for this purpose or other kinds of distortion will show up that the patent specification didn't tell you about.

### Unity-coupled

While Ultra-Linear operation makes pentode tubes much more tolerant of different loading, there is another fact about practical operation that allows us to use pentode operation, provided we do it the right way. This is the relationship between a speaker's impedance characteristic and power demand.

At the low-frequency end, where resonance causes a speaker's impedance characteristic to rise, resonance improves its electromechanical efficiency. What is needed is virtually constant *voltage* drive, rather than constant *power* drive. Less power is required if the speaker is matched to the amplifier in the region where its impedance is substantially resistive (see Fig. 1-a). This means that, although pentodes normally produce more distortion working into a higher load, we can utilize this impedance drive to reduce distortion by a greater ratio than the rise in impedance. The reduction in power demand from the output then results in a satisfactory distortion figure.

Reactive components in a speaker's impedance characteristic at the high-frequency end have a similar factor to help them. A speaker works best when fed by a constant voltage or high-damping-factor amplifier and, in most

**S**INCE I have written so many articles showing why different amplifiers cause different kinds of distortion and getting straight the way in which different circuits function, I have received a number of calls asking why don't I design a really good amplifier circuit using the best principles discussed. The reason is obvious—I have been too busy investigating and writing. However, it is time for the best principles to be put together into one amplifier. And—in response to popular demand—here it is.

Based on some of the popular misconceptions I have been bucking, some things this amplifier does will be derided by those who have been doing other things. So right here it will be well to explain just *why* the circuit is arranged the way it is:

Investigating different ways of coupling output tubes shows that using push-pull triodes gives the best chance of getting high quality with low distortion. But the output is rather inefficient, unless we go to transmitting triodes and get an output in the region of 100 to 200 watts by working in class B; in which case it is possible to achieve an efficiency comparable to, if not

higher than, that obtained at lower powers with pentodes.

Using simple push-pull pentode operation, the circuit is extremely critical of correct matching, which no practical loudspeaker achieves. The circuit is much more efficient in that the tubes give a much bigger output for lower cost, but the stability tolerances of an overall feedback arrangement can become very critical, especially of practical (speaker) loads. Many low-cost "high-fidelity" amplifiers do use push-pull pentodes with some degree of feedback in the output. But they cause their designers numerous headaches in getting distortion down to a satisfactory figure (working into a resistance load), juggling the circuit so it remains stable (if in fact it does) into the variety of possible practical loudspeaker loads and also adjusting the circuit so it *sounds* reasonably good.

The third alternative is Ultra-Linear. This splits the difference between triode and pentode operation and, in most tubes, also splits the difference in efficiency. As far as the *tubes* are concerned, it is often the best method of operation as regards linearity, but this is not the end of the story. You

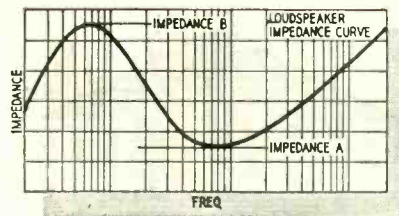
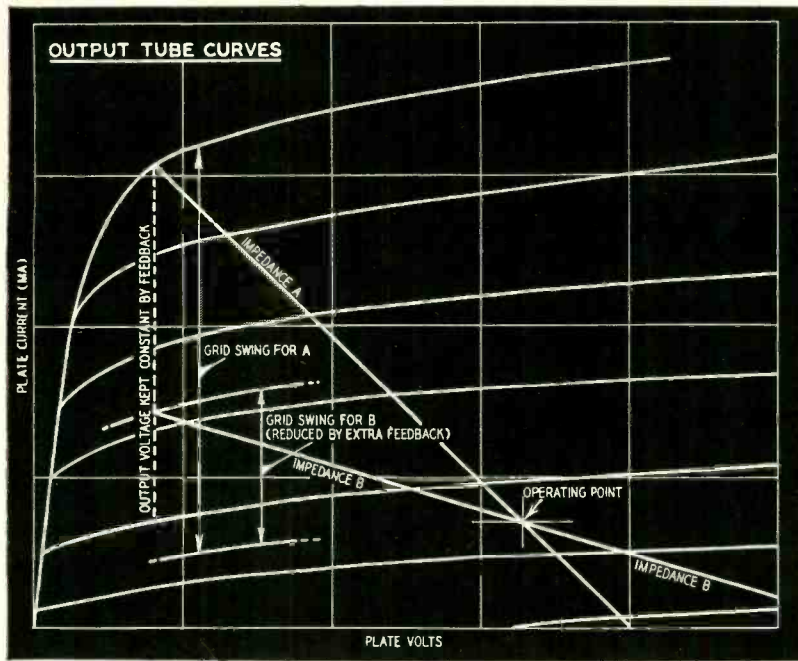

Fig. 1-a (above)—Speaker impedance varies with frequency. Fig. 1-b (left)—Properly applied voltage feedback can improve performance of pentodes into a speaker load without losing advantage of better efficiency.

program material, there is very little power at the extreme high frequencies. An amplifier using pentode output and a feedback arrangement that readjusts the tube operation to compensate for this (Fig. 1-b) and that delivers full power into a nominal resistance load over the entire audio-frequency range, will perform at least as well as the Ultra-Linear. It will be more efficient because pentode operation is still more efficient than Ultra-Linear, especially with class-B operation.

This is the philosophy behind two popular circuits, the unity-coupled by McIntosh and the Circlotron by Electro-Voice. The unity-coupled circuit uses a special output transformer, a vital feature of which is the bifilar winding of the primary. None of the transformer manufacturers produces a transformer for unity coupling, with a bifilar-wound primary. If they did, its cost would put unity coupling off the map for most amplifier builders. McIntosh can produce a competitive amplifier with this circuit only because they make their own transformers on a production line, integral with the manufacture of the amplifier itself.

The Circlotron is a circuit that is also specially adapted to production by a manufacturer who specializes in this type. The output transformer is not unusual (beyond having an unusual ratio), but the power transformer has to be because the circuit requires two separate high-voltage supplies.

**Twin-coupled circuit**

In the circuit I use, which I propose to call the twin-coupled circuit, instead of using two separate high-voltage supplies, or a very special bifilar-wound output transformer, I use a conventional power supply with two conventionally wound output transformers of moderate cost. The cost of these output transformers is such that two of

them can be obtained for less than the one found in more conventional high-quality amplifiers.

This is made possible by the use of a circuit which does not require output transformers to respond to frequencies far beyond the actual audible frequency range required, *merely to satisfy stability criteria* of the feedback circuit. It has always seemed to be a waste to require an output transformer that maintains response flat to somewhere between 100 kc and 1 mc to amplify satisfactorily frequencies that go up to only 20 kc.

The next question is how big are we going to make this amplifier? For the first model we decided to use a couple of EL84's to deliver a maximum output of 10-15 watts. This amplifier will deliver about 10 watts rms continuous sine wave. In practical audio program material it delivers the equivalent of 15 watt rms undistorted and 30 watts peak with slightly less than 1 volt input. This is because, when a continuous maximum output is passed, the B-plus voltage drops off a little and reduces the available power. So for performance comparison purposes this can be called a 15-watt amplifier.

The reason so small an output proves satisfactory is that it does not run into sudden kinds of distortion when the output is exceeded on momentary peaks. Careful observation and tests with various amplifiers of different power ratings have shown some interesting facts. Many circuits designed to deliver 50 watts or more probably deliver their rated output with very low distortion. But try to get 51 watts from a 50-watt amplifier and you will suddenly find you are getting only about 35 watts of *distorted* output.

This explains a fact that many have already noticed: that some lower power-output rated amplifiers give apparently cleaner and better output than those

with a bigger rating according to specification. Suppose we have an audio program run at an average level of, say, 5 watts, with peaks extending up to what should require 60 watts.

Using a 15-watt amplifier of good design, the average level will be pure and undistorted at 5 watts. The 60-watt peak will be slightly distorted, but clipped down to about 20 watts instead of 60. The overall result does not sound too bad.

Now the same apparent level from the 50-watt amplifier will sound considerably worse. The average 5-watt output, *by itself*, would sound the same as from the 15-watt amplifier. But the 60-watt peak drives the 50-watt amplifier into very severe distortion, so as to give only about 35 watts extremely distorted output. Not only this, but the distortion hangs over into the 5-watt level that immediately follows the 60-watt peak. Consequently even the average 5-watt level is much more distorted than it sounds in the well designed 15-watt amplifier.

To make the 50-watt amplifier sound as clean as the 15-watt amplifier we have to turn the gain control down so the peaks stay well below 50 watts, which means we shall no longer have the average operating level of 5 watts. Consequently the output will not sound as loud as it does from the 15-watt amplifier.

Based on this experience, the twin-coupled amplifier eliminates the causes of sudden-overload distortion and, surprisingly enough, gives performance that compares with many 50-watt amplifiers very favorably, although it is capable of delivering only 30 watts peak undistorted and 10 watts rms.

**Circuit details**

My circuit uses cathode bias. This is not an essential feature of the twin-coupled circuit but is thought best for this particular tube combination because the EL84 is rated to give 17 watts from a pair, either in class AB with cathode bias or in class B with fixed grid bias. Use of the class-B arrangement would improve power supply economy and possibly allow a bigger reserve power against maximum measured power—if this is an advantage. The disadvantage is that class-B operation with fixed bias runs us into that sudden-overload trouble.

There are ways of overcoming this problem by using extra tubes in the



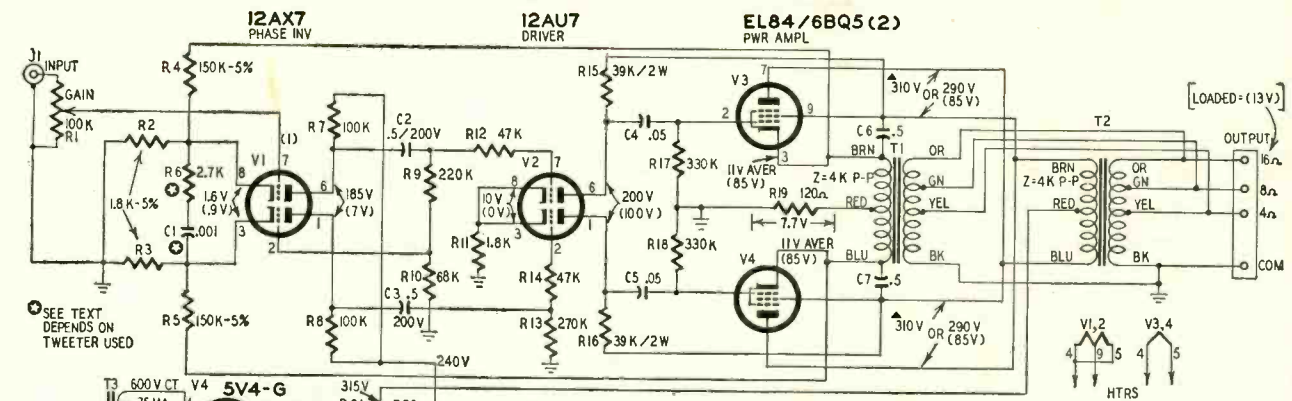

- SEE TEXT DEPENDS ON TWEETER USED
- 17V AC 3A
- 5V/2A
- 6.3V/3A TO HTRS
- R1—pot, 100,000 ohms, audio taper, with spst switch
  - R2, 3—1,800 ohms, 5%
  - R4, 5—150,000 ohms, 5%
  - R6—2,700 ohms, 5%
  - R7, 8—100,000 ohms
  - R9—220,000 ohms
  - R10—68,000 ohms
  - R11—1,800 ohms
  - R12, 14—47,000 ohms
  - R13, 26—270,000 ohms
  - R15, 16—39,000 ohms, 2 watts
  - R17, 18—330,000 ohms
  - R19—120 ohms, 2 watts
  - R20—33,000 ohms, 2 watts

- VOLTAGES IN PARENTHESES ARE AC WITH 1V INPUT SIGNAL
- ▲ WITH NO SIGNAL INPUT
- R21—1,000 ohms, 10 watts, wirewound
  - R22—pot, 50,000 ohms, linear tapes
  - R23—47,000 ohms
  - R24, 25—100,000 ohms
  - All resistors 1/2 watt, 10% unless noted
  - C1—.001 μf
  - C2, 3—0.5 μf, 200 volts, paper tubular
  - C4, 5—.05 μf, 600 volts
  - C6, 7—0.5 μf, 600 volts, paper tubular
  - C8—40—80—20 μf, 450 volts, electrolytic, can type
  - F—Fuse, 3 amp
  - J1, 2—phono jacks
  - S—spst switch on R1
  - T1, 2—output transformers, 7 1/2 watts, 4,000 ohms, plate to plate ct: 8-, 16-, 32-ohm secondary (Chicago Standard A-8094, Thordarson Meissner 22521, Merit A-2997, Triad S-34X
  - T3—power transformer: primary, 117 volts; secondary,

- Parts List includes components for alternate circuits in Figs. 5 and 6.
- 600 volts, ct. 75 ma; 5 volts, 2 amp; 6.3 volts, 3 amp. (Triad R9A, Chicago PV70A or equivalent)
  - V1—12AX7
  - V2—12AU7
  - V3, 4—Amperex EL84
  - V5—5V4
  - Chassis, 9 x 7 x 2 inches
  - Sockets, 9-pin shielded (2)
  - Sockets, 9-pin unshielded (2)
  - Socket, octal
  - Fuse extractor post
  - Barrier strip, Cinch-Jones 4-141 or equivalent
  - Grommets, 3/8 inch (4)
  - Grommet, 1/4 inch
  - Tie strip, Cinch Jones 52A
  - Tie strip, Cinch Jones 53C (one mounting lug removed)
  - Miscellaneous hardware

Fig. 2—Circuit of the twin-coupled amplifier.

circuit, but, for the purpose of this amplifier, as class-AB operation gives the same output as class B, the simpler method (and the cheaper one) is to switch to cathode bias and use class AB. Fig. 2 is the amplifier schematic.

The next point involves the choice of phase inversion. One idea considered was to use the 12AX7 with one half operating as a split-load phase inverter. This would enable single-ended feedback to be used, which was one reason for abandoning it. As we shall see, there are advantages to the use of entirely push-pull feedback in this circuit. The other reason is that the split-load phase inverter comes immediately before the 12AU7 driver (V2), which has boot-strap coupling in the plate circuit to get enough swing to drive the output tubes. This means that the input grid swing to the 12AU7 on each half is just about the maximum possible by the time you reach maximum output from the EL84's. Under this condition a split-load phase inverter introduces a rather curious distortion and one which overall feedback tends to exaggerate rather than minimize.

When the grid of the 12AU7 coupled to the cathode of the split-load phase inverter begins to conduct, as it will if peak output is even slightly exceeded, it clips the waveform, the same as with any other grid current in an R-C-coupled circuit. But, as well as clipping the waveform of the drive stage coupled to the cathode, it produces a very sharp peak in the waveform fed to the other half of the 12AU7. This is because the cathode half of the split load is virtually bypassed by zero impedance as soon as grid current begins to flow in the tube it drives. This means that the tube

begins to operate into the plate half of the load as a full amplifier, instead of a split-load inverter. Consequently a sudden, very sharp pointed peak, in a negative direction, appears in the plate circuit (Fig. 3).

All of this begins to happen at about the same time other circuits reach overload points. The effect of feedback is to exaggerate this sharp peak. It takes a variety of forms at different frequencies. Some places appearing as a

notch, at other places it begins to look like a damped parasitic oscillation on the waveform. This is shown by Fig. 4.

This defect can be avoided by using push-pull operation throughout, which is the circuit I finally adopted. A further advantage of using push-pull operation throughout is that it allows entirely push-pull feedback. This means the output transformers can be removed from the feedback loop. Some will immediately object that this means the

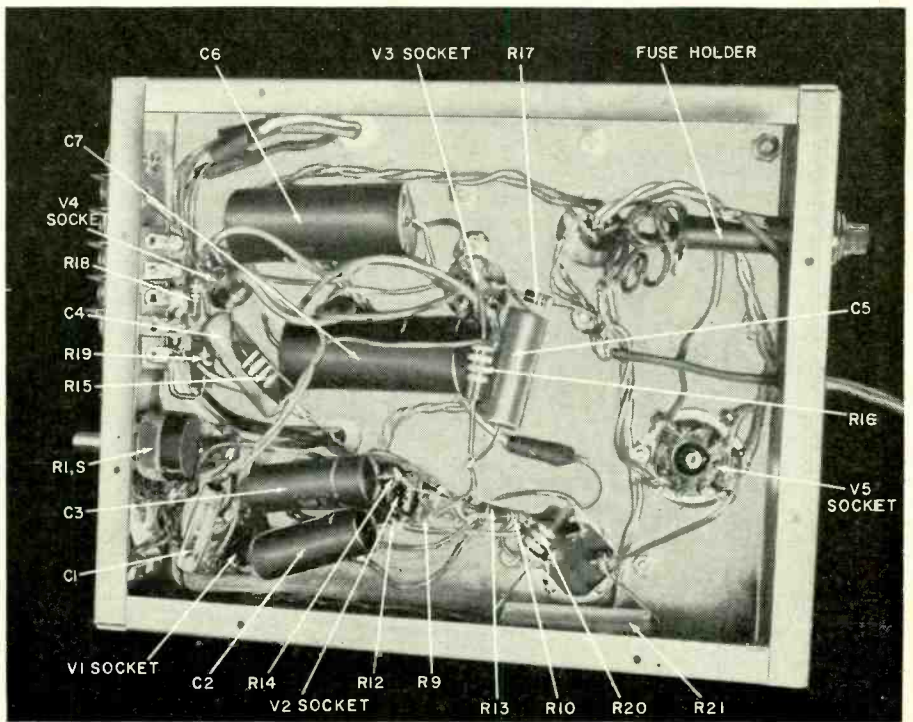

Underchassis view shows the relatively uncluttered wiring.

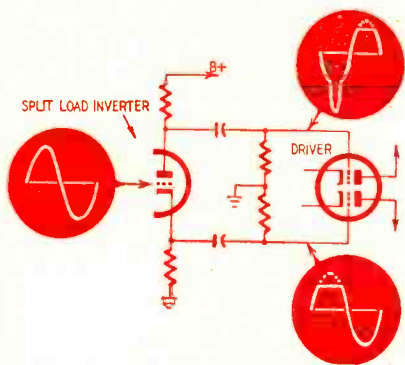

Fig. 3—Waveform distortion due to split-load and other inverters, when operated to maximum swing of following stage.

feedback does not cancel distortion "produced by" the output transformer. This is not true, as I have shown in previous articles.

Output transformers cause distortion in two ways: by the direct effect of the magnetizing current at low frequencies or due to their internal reactance at very high frequencies.

Usually the latter effect is produced, only due to the method of operating the tube or due to overall feedback. Consequently, removing the transformers from the overall feedback loop, rather than allowing them to produce distortion at the high-frequency end, frees them from the liability of doing so and also makes it possible to use a transformer that does not have to respond up to 100 kc or higher to produce satisfactory performance up to 20 kc.

At the low-frequency end, feedback from the primary is as effective in reducing distortion due to transformer magnetizing current as feedback from the secondary. So, by using overall feedback from the output tubes back to the input 12AX7, we avoid the need for unnecessarily high-quality output transformers and produce an amplifier which is inherently more stable than any kind of circuit with output transformers in the feedback loop.

In this circuit it is important to have close tolerance values for feedback resistors R2 and R3 in the cathodes of the 12AX7 and R4 and R5 from the cathodes of the EL84's. These resistors should be 5% tolerance or better.

The phase-inversion circuit is somewhat new, although it looks like a straight paraphase. It is different because the overall feedback operation is included in phase inversion. If the inversion provided by resistors R9 and R10 is not exact, overall feedback will correct for this.

The use of a paraphase inversion is still liable to produce an effect similar to that described with the split-load phase inverter. The presence of overall feedback in push-pull minimizes the effect, but it still can increase the distortion a little before the clipping point is reached, due to the fact that 12AU7's do not start to conduct grid current suddenly.

The remedy for this is to insert resistors R12 and R14 in series with the 12AU7's grids. This prevents the slight grid current commencement at pin 7 of the 12AU7 from being reflected into the 12AX7 grid at pin 2 and producing an asymmetrical signal through the amplifier. Instead the signal fed to pin 2 of the 12AX7 is a true inversion of that at the input, pin 7. The slight droop at maximum signal, due to the very small commencement of grid current through R12 and R14, is symmetrical and readily compensated for by the feedback arrangement, until clipping occurs on the output tubes.

Checks with the indicated values for R9 and R10, used for phase inversion, show that close tolerance is not critical. The closely controlled push-pull feedback takes care of slight fluctuations at this point. Serious deviation from the correct values, such as using 47,000 or 100,000 ohms in place of 68,000 ohms, will result in unbalance in the drive to the 12AU7 and consequent un-

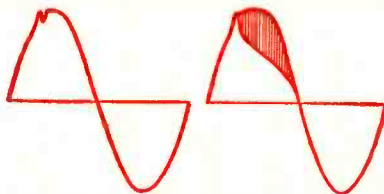

Fig. 4—Two waveforms resulting from the effect of Fig. 3 working in a feedback amplifier.

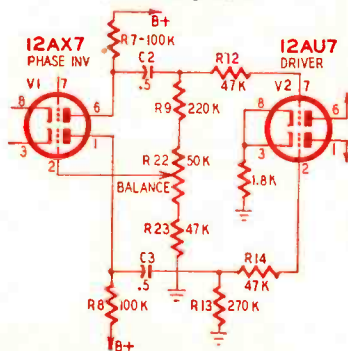

Fig. 5—Circuit shows how to add a balance control.

balance in the drive to the EL84's. This will be approximately equalized in the output due to the transformer and cross-coupling action, so the feedback signal gets almost equalized by the time it reaches the cathodes of the 12AX7. The degree of unbalance in the drive to the 12AU7 and EL84's will be less than the degree of error in the phase-inverter values. Due to feedback action, the feedback signal at V1's cathode will be unequal to compensate for the inequality the phase inversion tends to produce.

But to produce maximum output and avoid a form of notch distortion, which may show up above 3,000 cycles, it is best to use the indicated values for R9 and R10, as well as close-tolerance feedback resistors. If you want to incorporate a refinement to be sure of obtaining absolutely the best performance from this amplifier (and some people always like to have a BALANCE

control in a push-pull amplifier) use a 50,000-ohm potentiometer in conjunction with a 47,000-ohm resistor in the phase-inverter circuit. This circuit is shown in Fig. 5. Adjust the BALANCE control for equal voltages on the grids of the 12AU7, at a 1,000-cycle input signal.

Another comparatively minor advantage of this amplifier circuit is that it readily lends itself to modification to push-pull input. This has some advantages if you wish to operate the amplifier with a compressor, expander or coded controls, using variable-gain stages ahead of it. These circuits work with much less distortion if the variable-gain tubes are used in push-pull so as to give a push-pull output. In using this amplifier, it is then possible to use push-pull coupling throughout. All that is necessary to make the change is to remove the phase-inversion components, put another 270,000-ohm unit in the grid circuit to pin 2 of the 12AX7 and bring out another input lead. This is shown in Fig. 6.

How it works

Now come the points that everyone wants to know—how this amplifier really works. It uses two output transformers, the primary of one being in the cathode circuit while the primary of the other is in the plate and screen circuits, with these cross-coupled. The secondaries are connected in parallel, not only at the ends but at each tap. This means that whichever secondary tap is used, half the output current will be delivered by each transformer.

On the primary the same resultant current flows through both transformer windings because they are virtually in series. The high voltage goes in at the center tap of one, through the tubes and out through the center tap of the other from the cathodes. So half the audio voltage is developed on each output transformer's primary.

For the extremely low frequencies, magnetic coupling from one primary to the other by the parallel-connected secondaries is sufficient to insure that screen voltage is always in phase with cathode voltage and that plate voltage is equal but in opposite phase on each tube. To take care of the middle and higher frequencies, where the leakage inductance of the transformer would loosen off this coupling, the simple expedient of placing a 0.5- $\mu$ f capacitor between screen and cathode of each tube is used. This means that good coupling

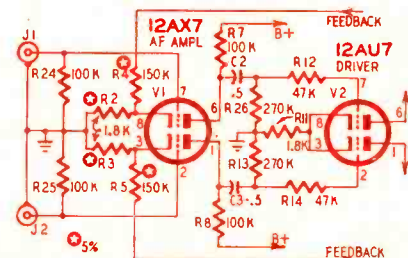

Fig. 6—Circuit modification provides push-pull input.

in the tube is maintained out to a frequency far beyond that possible in an output circuit of this type where the correct maintenance of voltage between screen and cathode depends on transformer coupling.

Here many will ask, "Why, if you are using a low-cost transformer of conventional construction, do you have to get one specially made?" This was something I hoped to avoid. But everything I could find listed had to be rejected for one of two reasons.

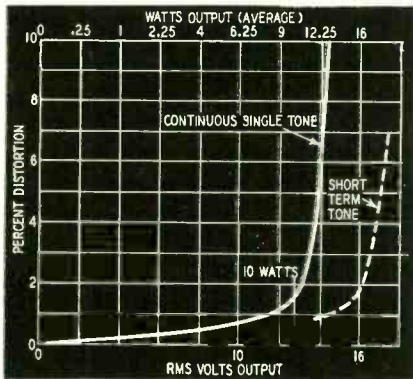

Fig. 7—Distortion characteristic: for continuous tone and short-term power demand. Harmonic content below the sharp upward turn is almost entirely second, negligible third and higher order.

Single-ratio transformers in this power rating (7.5 watts per transformer, since each delivers half the total) do not have the right impedances. As we have explained, the primary of each transformer presents half the normal plate-to-plate load for these tubes. Also the nominal secondary impedance needs to be twice that of the speaker system to which the two are connected, as they supply the total power in parallel, between them.

Some of the so-called "universal-output" transformers might include the correct impedance ratios. But these types are invariably intended for even poorer frequency range than we can tolerate. While complicated design, to get an unnecessary high end response, can be avoided, we still need iron to get the low end. Most of the universal type list a weight of less than 1 pound, which means they could never give power below 60 cycles—if they go that far.

For this reason, I designed a suitable transformer for the job (although two transformers are used, they are identical) and had them made up. Having proved that the amplifier works up to expectations, a number of well-known transformer manufacturers have agreed to cooperate with readers of this magazine by making this type available and the suitable new type numbers are listed in the parts list.

If you should have a couple of old transformers lying around that you would like to try in this circuit, remember that the plate-to-plate load must be half the normal value for the tubes, and the secondary rating for impedance must be double the speaker impedance with which you will use it.

As feedback is taken directly from the cathode, which is only at a low voltage above ground, it is unnecessary to use blocking capacitors in series with feedback resistors R4 and R5. This eliminates a potential cause of low-frequency instability.

Cathode degeneration, due to half the power being taken from the cathode circuits of the EL84's, reduces the effective voltage gain of these tubes as output tubes by about 12 db, operating into correctly matched load. (Operating open circuit, this would be a reduction of about 35 db.) This means damping factor, before any overall feedback is applied at all, is equal to approximately 3 or 4.

The boot-strap circuit has the effect of increasing the dynamic load line for V2 by a corresponding factor of 4 times due to the 12-db degeneration in the output stage. This more than doubles the available swing from the 12AU7, but it does not have the effect of degenerating the distortion-reducing effects of negative feedback by the same factor.

This is because V2's gain is not boosted by the same amount as its available swing. Working with the 39,000-ohm plate resistor, V2's gain, with a plate resistance of about 7,000 ohms, comes out to 39/46 times the amplification factor of the tube, which is 17. This figures to about 14.4. Using the dynamic load of 4 times 39,000 ohms, or approximately 160,000 ohms, the gain of the tube rises to 160/167 times the amplification factor of 17, or about 16.3. So the change in gain, due to the boot-strap effect, is from 14.4 to 16.3, which is little more than 1 db.

Another comment on this circuit may refer to the absence of cathode-bypass capacitors, on either the 12AU7 or EL84 bias resistors. In both instances, the use of a cathode-bypass capacitor not only increases the distortion produced by the pair of tubes, but also

reduces the available swing as compared with the unbypassed condition. Thus leaving out the bypass capacitors is not a matter of economy, it produces better performance.

With the 12AU7 boot-strap drive circuit, the damping factor of this amplifier is still in the region between 3 and 4 (a little nearer to 3 than to 4). The overall feedback provided by the 150,000- and 1,800-ohm resistors is around 14 db, which boosts the basic damping factor of the amplifier by 5 times, to about 15. Winding losses in the output transformers reduce this, at the output terminals, to between 8 and 10, according to the tap used. As the winding losses in the transformer are still only a small fraction of the speaker's voice coil resistance, this cannot be regarded as a serious deterioration in damping.

From the feedback viewpoint, the overall feedback loop contains three rolloffs at the low-frequency end of the response. The reactances contributing to this rolloff are C2, C3, C4, C5 and the primary inductance of the output transformers, the latter being the limiting factor. The other values are optimized to minimize possible bounce effects with any practical load reactance possibilities. This produces level response down to 20 cycles.

At the high-frequency end, cathode degeneration of the EL84's prevents either plate or cathode circuits from introducing any effective rolloff up to a much higher limit than that produced in the other circuits. The effective roll-offs are due to the V2 grids as a capacitance loading on the plate circuits of V1 with the 47,000-ohm resistors in series, and due to the EL84 grids as a capacitance loading on the plate circuit of the 12AU7. Without any compensation, the overall response of the amplifier is level up to well above 10 kc, although there is a loss of about 1 db between 15 and 20 kc.

(Continued bottom page 44)

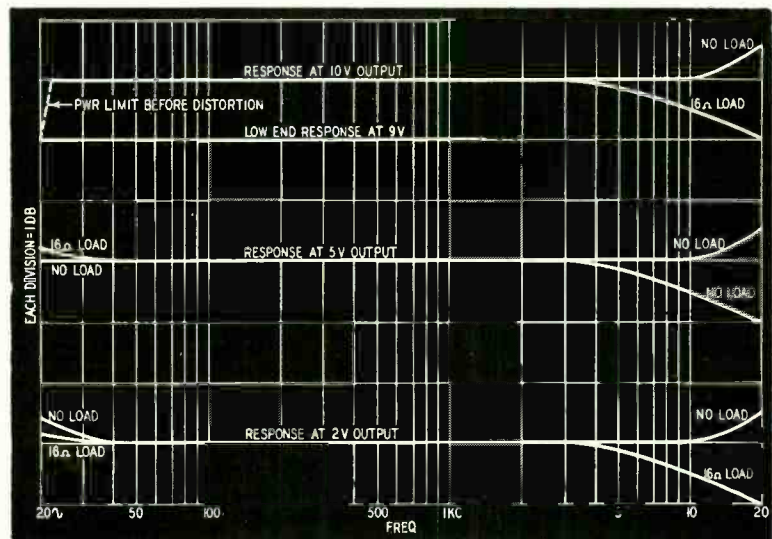

Fig. 8—Frequency response at different levels; measured with continuous tone. Taken with R6-C1 connected. Operation into dynamic speaker or combination with dynamic tweeter comes out nearer to flat than either high-end curve. For electrostatic tweeter (without internal compensation of any kind) and R6-C1 removed, response is about  $\pm 2$  db at 20,000 cycles, according to tweeter referred capacitance.

# LOUDSPEAKERS

...of the future

By GERALD SHIRLEY

*A glimpse of how tomorrow's loudspeakers may look and operate*

**I**n the field of transducers which convert electrical energy into acoustical energy, the long-held supremacy of the cone type speaker is being challenged by new types of loudspeakers. Principally these are electrostatic, Ionophone and Corona Wind.

Strictly speaking, electrostatic speakers are not new; their theory was well understood long ago; in fact there were one or more commercial versions as far back as the Nineteen Thirties—Kylotron, manufactured by United Reproducers. These early models suffered from arc-over, dielectric breakdown and limited performance due to a lack of suitable materials in those days. As a result they dropped out of competition. In recent years the development of myriad new materials and plastics has made possible the successful revival of the electrostatics. In their push-pull, high-fidelity versions—notably JansZen and Pickering—they have already won many adherents among audiophiles.

The Ionophone was first demonstrated by Sigfried Klein, the French scientist, several years ago. This tweeter was probably the first sound-producing transducer having no moving

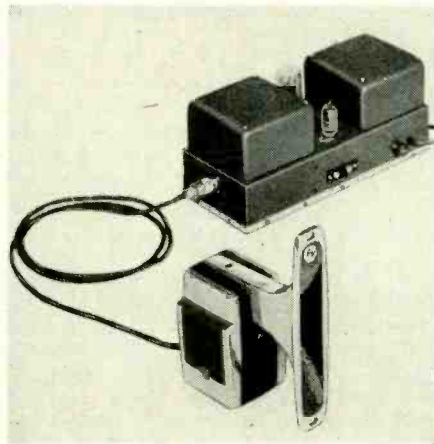

Fig. 1—The Electro-Voice Ionovac.

parts. Commercial versions of the Ionophone have been in use in France for several years, principally in theaters, and production in Germany and England by licensees is reported to have begun last year. In the United States the rights to the Ionophone were acquired by the DuKane Corp., and, after a year of intensive research under the direction of their chief engineer,

William Torn, working with the inventor himself, the company has announced an improved model. Electro-Voice Co. will distribute the home hi-fi version for DuKane; its price is about \$150. The American version of the Ionophone has been renamed the Ionovac (see Fig. 1) and is made by Electro-Voice. (The etymology of this rechristening appears somewhat obscure since the suffix vac usually connotes the word vacuum.) How well the Ionovac tweeter will be received by the Golden-Ear crowd remains to be seen, although it seems reasonable to expect that the quality of reproduction should be excellent.

### Corona Wind loudspeaker

The newest development in the speaker field is the Corona Wind loudspeaker (CWLS). Like the Ionophone it has no moving parts. However, it has the additional advantage of being inherently a wide-range transducer, with response right down to zero cycles. The CWLS is the invention of a New Zealand-born engineer, Dr. David M. Tombs, who began his work on the speaker several years ago while senior lecturer in tele-

## HI-FI TWIN-COUPLED AMPLIFIER (Continued)

Use of resistor R6 and capacitor C1 between V1's cathodes levels off the response to 20 kc, working into a resistance load or open circuit.

The circuit as shown will work well into any dynamic speaker combination. But for a system with an electrostatic tweeter it will produce from 6-8-db boost at about 20 kc. This can be reduced to about 2 db, which will sound quite smooth, by omitting R5 and C1. Distortion characteristic and frequency response are shown in Figs. 7 and 8. The 2 db can be eliminated by inserting a resistance about half the value of the nominal impedance (8 ohms on the 16-ohm output) in series with the tweeter feed. This will affect only the 20-kc response.

### Construction kinks

C6 and C7 should be arranged to get as direct a coupling as possible between cathode and screen. This is achieved

by spacing the tube sockets so the capacitors may be wired directly and snugly into this position. The output transformers are then oriented to keep all primary leads short. These are the only precautions necessary in chassis layout to insure stability.

In this amplifier circuit, ground returns are no problem at all as regards stability. But careless ground returns can result in slight hum induction. This conforms with the general pattern of precautions for power amplifier wiring. C8 may have its case directly grounded to the chassis, in which case the input ground should be isolated from chassis and a return taken to the point where the supply goes to ground at the electrolytic capacitor. Alternatively the electrolytic capacitor may be isolated from ground by using the bakelite wafer that comes with it, in which case the input socket can be solidly grounded and a return taken

from the supply ground back to the input. All other amplifier grounds should then be taken to the supply ground rather than the input ground, to avoid internal ripple coupling back to the input. These precautions are necessary only if you are aiming to get a hum level in the region of 90 db or even better.

This is the first constructor amplifier utilizing the new twin-coupled output circuit. The circuit is not, of course, restricted to application to EL84 tubes. For bigger outputs class-B operation could be utilized with suitable transformers for the purpose and a method of coupling between the drive and the output stage that obviates the sudden overload characteristic of class-B unity-coupled operation. If interest in a higher-output twin-coupled amplifier warrants it, we will pursue the matter and publish later a design for a further circuit with bigger output. END

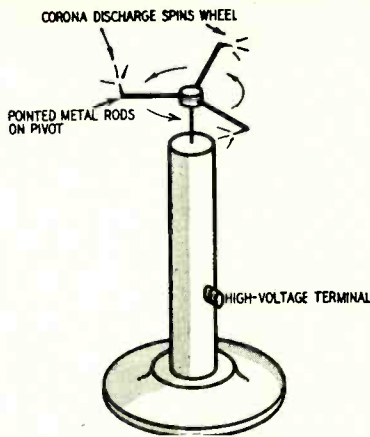

Fig. 2—Physics experiment shows effect of corona wind. The wheel spins exactly as if air were jetting out of each point.

communications at the Imperial College of Science and Technology of London University. At present, Dr. Tombs is director of research at Hoover, Ltd., an important British manufacturing concern.

In this article I will explain the theory of the CWLS, discuss its present and potential characteristics and compare it with the other new types of speakers. There will be no discussion on the theory and construction of Ionophone and electrostatic speakers, as RADIO-ELECTRONICS readers are already familiar with them. (Articles on the Ionophone appeared in RADIO-ELECTRONICS, November and December, 1951. Articles on electrostatic speakers appeared in RADIO-CRAFT, December, 1929, and January, 1930, with shorter items on the newer electrostatics scattered through the past few years.)

The basic phenomenon which makes the CWLS possible is corona wind. Whenever there is a corona discharge, it is accompanied by a movement of air away from the discharge point. Fig. 2 is a physics experiment used to show this action. Corona discharge from a sharp point is a product of high voltage and is made possible by ionization of the air—the air actually becomes conducting. For reasons not yet completely understood, the wind which emanates from a corona discharge point having a positive voltage appears to be stronger than the wind from a negative point.

Once the possibility of producing a wind exists, then there is the possibility of producing sound if a method of modulating that wind can be found. It is no trick to modulate wind mechanically through the use of a fast-acting valve, and in fact such devices have been used with compressed air to produce very powerful PA systems. However, this is *not* the way to get high fidelity. Dr. Tombs reasoned that, since the flow of corona current and the movement of wind were directly related, it should be possible to control the wind indirectly by controlling the current. To test this theory he mounted a smooth, round ring in the vicinity of a corona-discharging electrode and

found that by adjusting its position and voltage it could be made to behave very much like the grid of a vacuum-tube triode. As shown diagrammatically in Fig. 3-a, this is actually an embryonic loudspeaker. Note that the collector electrode or anode is blunt—that is, it has a smooth, broad surface. With this type of electrode structure the ac sound component is superimposed on a steady, unidirectional wind; the electrical analogue would be modulated dc or ac with a dc component. To eliminate this background wind, which serves no useful purpose and would probably be distracting if audible, Dr. Tombs next tried using a sharp electrode for the anode. This produced its own wind which opposed the wind from the cathode and it was found possible, by adjusting the voltage and position of the grid, to achieve a state of no wind with zero input signal. (See Fig. 3-b.)

This is the form which has been utilized in making small prototype speakers for laboratory studies and demonstrations of the device. It can be seen from Figs. 4 and 5 that a great many pairs of needles are used; the reason for this is simply that the amount of sound produced by a single pair is very faint. It has been estimated that for the average living room a needle field having an area of between 2 and 4 square feet will be required.

The Corona Wind loudspeaker appears to possess several significant virtues. Most of these arise from the fact that there are no moving parts, hence no resonances or nonlinear suspension problems such as are encountered in conventional cone and diaphragm speakers and drivers. The frequency response goes right down to zero and extends well up into the ultrasonic region at the upper end. The response curves taken on the early experimental models are not yet absolutely flat but it is expected that, since flat response is theoretically possible, further research and development should make it a reality.

Speaker comparison

It is interesting to compare the Corona Wind loudspeaker with the Ionophone and electrostatic types, since there are both common characteristics and differences between them. Taking the Ionophone first, the most conspicuous similarity is, of course, the absence of moving parts. Both types require a high voltage. The Ionophone is powered and driven by an rf, amplitude-modulated transmitter. The CWLS is powered by a high-voltage dc power supply and driven by an audio signal of high peak-to-peak voltage, but no audio watts are required. The Ionophone is a point source of sound and requires a horn to couple its output to the room air load. The CWLS is an area device and requires no coupling mechanism or transformer. However, when it is to be used as a full-range reproducer, it will require suitable baffling just like any woofer—to prevent

cancellation effects between front and back waves. (Either an infinite baffle or a bass-reflex enclosure should work properly with the CWLS.)

The Ionophone appears to be inherently a single-ended transducer. According to published graphs, its distortion varies inversely with frequency and this is perhaps the most important reason why its use is limited to tweeter applications. (The other reason, of course, is the horn problem.) The CWLS in its single-ended forms, as shown in Figs. 3-a and 3-b, is subject to square-law distortion in much the same manner as single-ended electrostatic speakers. Fortunately it is very easy to recast the CWLS in push-pull form (see Fig. 3-c), significantly reducing distortion.

The Ionophone is said to generate considerable internal heat, which may necessitate occasional replacement of the quartz cell. The CWLS, on the other hand, generates ozone which is corrosive to many metals. It would probably be desirable in a commercial CWLS to have the electrodes and grids made of a corrosion-resistant material such as stainless steel.

Lastly, the Ionophone appears to operate as a power diode whereas the CWLS operates as a power triode. This would seem to imply greater efficiency for the CWLS.

Turning now to electrostatic speakers (Pickering makes one called the Iso-phase, see Fig. 6), the first point of similarity to the CWLS is that both are area devices rather than point sources of sound. This particular characteristic of sound-producing transducers appears to be taking on more importance recently. This may have something to do with the increasing interest in and growth of stereo (and pseudo-stereo) reproduction. All other things being equal in a high-fidelity

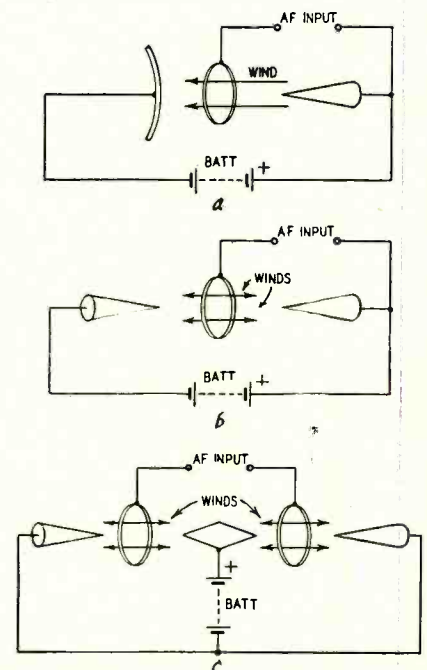

Fig. 3—Basic circuit of the Corona Wind loudspeaker.

## AUDIO—HIGH FIDELITY

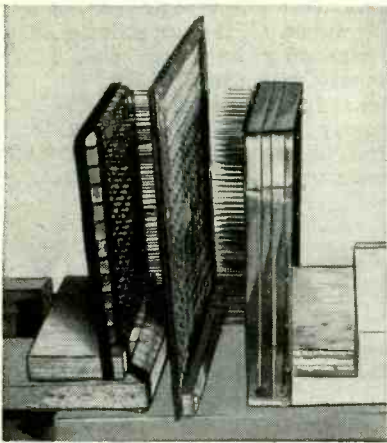

Fig. 4 (left)—One of first experimental Corona Wind speakers.

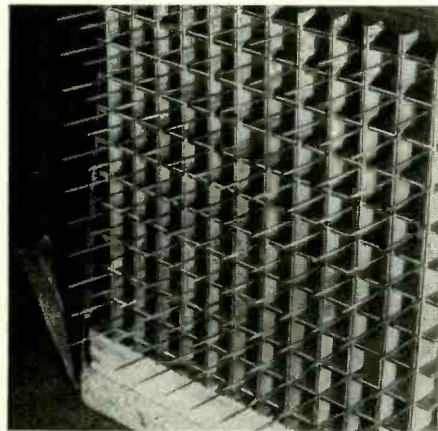

Fig. 5—Closeup shows one of needle fields used in Corona Wind speaker.

single-channel system, if the middle and upper-middle frequencies are generated by a large area reproducer, the reproduction just seems to sound better than when the source is small.

The electrostatic speaker utilizes a high voltage, too, but its characteristics and function are quite different from the other two types. In the electrostatics the voltage is used for polarizing the field, the potential is kept below that which would cause ionization and very little current is drawn. The power to drive the electrostatic speaker must be in the form of actual audio watts. (This creates something of a problem for some amplifiers since the load seen by the output tubes is almost pure capacitance.)

The lightweight diaphragm of the electrostatic speaker comes fairly close to the no-moving-parts ideal of the CWLS and Ionophone, but still imposes certain limitations on the speaker's performance. At the high end this limitation is not immediately apparent since fairly flat response to 20,000 cycles or higher has been achieved. The significant fact here, though, is that different makes of electrostatic speakers do sound different from each other and this is evidence that the diaphragms are somewhat coloring the output, no matter how slightly. As long as this is so, it is hard to see how the claim—made in certain quarters—that the output is absolutely indistinguishable from the original sound can be sus-

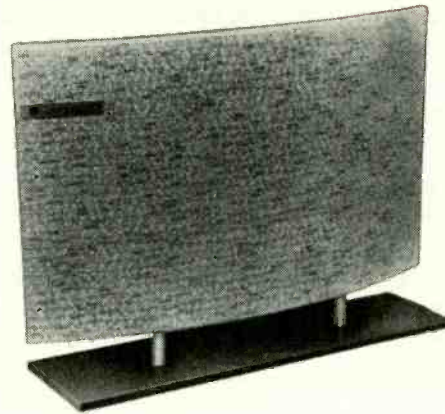

Fig. 6—Pickering's Isophase, an electrostatic loudspeaker.



Fig. 7—The Jans-Zen electrostatic speaker.

tained. The current push-pull electrostatics represent a marked advance in the art and to many listeners are an improvement over cone and compression type tweeters. But until the Ionovac and CWLS have also been heard from, no speaker should be accorded the title of ultimate.

At the low end of the frequency spectrum, the limited amplitude of excursion of its diaphragm makes it difficult for the electrostatic to perform effectively—to move a lot of air. The limits on diaphragm excursion are dictated by the necessary methods of suspension and even more so by the close proximity of the polarizing plates. The only out for the electrostatic that wants to woof is to grow bigger, but obviously there are limits here too. Since the CWLS does not have a diaphragm, it is apparently not as severely limited in this respect and should be able to move considerably more air at low frequencies than an electrostatic of the same overall area. Several wide-range electrostatics have been developed and demonstrated. I have heard two models so far and they are not in the same league with Klipschorns, AR's or even a good bass-reflex job. If you want that frightening whomp from a bass drum (with the volume turned up a little, of course) or that semi-earth-

quake feeling which a 32-cycle (or lower) organ pedal tone can generate, you'll stick with your old-fashioned cone type woofer for the time being. Time will tell whether with further improvements the electrostatics can equal these older types, and whether the Corona Wind loudspeaker too can equal and perhaps even surpass them.

So much for comparisons. It must be pointed out in closing that, while the electrostatic and Ionophone types are already available, the CWLS is still in the experimental stage and considerable research and development will be necessary to bring it out of the laboratory and into the home. The research will have to start at a very elementary level since little is known about this aspect of corona—the associated wind. The effects of all the variable parameters—shapes and sizes of electrodes and grids, spacing, positioning, voltages, etc.—have to be studied individually and then in combination to find the optimum design centers. (Some of this research has already been started in various universities.) Since at the present time there is no timetable on the CWLS, you are advised not to put off assembling your dream systems until you can obtain one. It will probably be several years at least before they are available. END

# LOOK... what Radio-Electronics has in store for you in the months ahead...

- Direct-Reading Audio Frequency Meter
- Servicing New Auto Radios
- New Amplifier with KT-88 Tubes
- Tricky Circuits in TV
- Common Fallacies in Color TV Servicing

- Tricks with Neon Lamps
- Tiny-Tran—A Real Pocket Radio
- Substitution Resistance Boxes Make Servicing Easy
- Cheap TV Substitution Picture Tube

The DECEMBER issue of RADIO-ELECTRONICS goes on sale November 26 at all better parts distributors and newsstands

### SUBSCRIPTION RATES

One year \$4.00

Two years \$7.00

Three years \$9.00

RADIO-ELECTRONICS

154 West 14th Street, New York 11, N.Y.

Part I—How to use available tube data for R-C-coupled pentode amplifier design

# Tube Data and Amplifier Design

By HERBERT RAVENSWOOD

**D**ESPITE manufacturers' efforts in preparing tube manuals, we sometimes need data that is not there. This article shows how to make the best of what is given.

The variety of circuits in which tubes are used and the ever-enlarging range of tube types make presenting adequate information about their performance in different circuits quite a problem for the tube manufacturers. In spite of the ever-growing variety, and the good job done in supplying data, we sometimes find it hard to locate a tube with just the right combination of characteristics to suit the purpose we have in mind. When we find a tube that looks about right, often the manual we are using does not present the information in an easy form to apply to our problem!

I have no less than a dozen tube manuals, of which more than half are the type maintained as a service in a loose-leaf binder. Even with this comprehensive data, I sometimes have to interpolate and figure out what I want by "inspired guesswork." But before proceeding with "how to make good guesses," some readers will want to know what is the best tube manual.

## Some tube manuals

Probably the best buy, value for money, is the *RCA Receiving Tube Manual*, at 60c. The current edition includes 20 tabular charts of information about R-C-coupled amplifiers, covering 56 tube types, pentodes and triodes. These charts give all the essential data for three B-supply voltages, with three plate-coupling resistor values for each. A selection of three grid resistor values for the following stage with each coupling resistor is also provided. This means a total of 27 sets of operating conditions for each chart. Each lists values for the remaining resistors in the circuit, the voltage gain achieved and the maximum output available, together with capacitor values for a rolloff at 100 cycles.

From this information the design of an R-C stage can easily be completed, according to the circuit's requirements. If the desired low-frequency rolloff is 20 cycles, just multiply all capacitor values by 5 and take the next larger stock value. For example, if the cathode bypass capacitor is given as 3.7  $\mu$ f, a minimum of 18.75  $\mu$ f, is needed for a 20-cycle rolloff, so a 25- $\mu$ f capacitor will be adequate.

The maximum available output is based on the clipping point for the operating condition given. No information about distortion is given in these tables.

Another easily obtained manual is published by Sylvania. This costs \$2 and includes service. It, too, has a tabulated section for R-C amplifier design, with 22 tables covering 73 tube types. In general, these are the same types as those covered in the RCA manual, but each has some the other misses. Also the information listed differs. The Sylvania tabulation does not give capacitor values but does include information on distortion at two different operating levels, giving gain, volts in and out for each level.

For completeness of tube type coverage, Tung-Sol service is probably best, giving you two large loose-leaf binders for the purpose. They do not include a convenient listing for R-C design like RCA and Sylvania. The Tung-Sol service includes tube types other than those manufactured by them, for the sake of completeness, but even this service does not list every type, although it is probably the most comprehensive manual available in that direction.

For completeness of data on tubes covered, the Brimar application report service seems about the best (available from Standard Telephones & Cables, Valve Dept., Footscray, Kent, England). Unfortunately, in the few years that this service has been operating, they have covered little more than a couple of dozen tube types. The Mullard Data service, also very comprehensive

in detail, only covers Mullard tubes and is not readily applicable to American types—especially as Mullard uses their own tube numbering system.

I will not go on and list the merits and demerits of every tube manual available and I hope that no manufacturers will feel slighted because they have not been mentioned. All probably list something that the others miss, although much of the coverage is almost identical. But with all this information, we may still fail to find the data that would be most helpful for a particular job.

## Pentode circuits

As an example, I recently had an application for which the tubes listed in the R-C-coupled section were not suitable. A number of channels with an input never exceeding 1 volt required maximum amplification in a single tube with minimum current drain, and the output had to be at an impedance not much lower than 100,000 ohms. A job for a sharp-cutoff pentode. Thumbing through the available types, the 6AG5 looked most likely, but neither of the manuals has it in the R-C section because its usual application is in if or rf circuits.

The available data is listed below:

Plate (volts)	100	125	250
Grid No. 2 (screen)(volts)	100	125	150
Cathode resistor (ohms)	180	100	180
Plate (ma)	4.5	7.2	6.5
Grid No. 2 (ma)	1.4	2.1	2.0
Transconductance ( $\mu$ mhos)	4,500	5,100	5,000
Plate resistance (megohms)	0.6	0.5	0.8
Grid No. 1 (volts for $I_b = 10 \mu$ a)	-5	-6	-8

This information is found in several manuals. The only difference is that the items are in a different order. Where do we go from here?

The following procedure has been found fairly reliable and produced a good answer to this problem. We have specified that the plate coupling resistor must be 100,000 ohms. For maximum swing, using a B plus of 250 volts, we

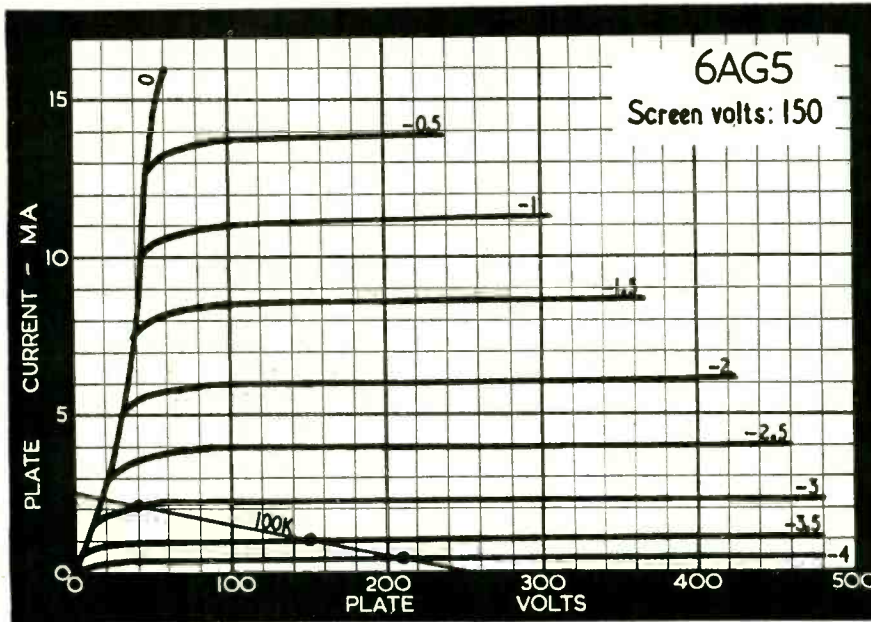

Fig. 1—Characteristic curves of 6AG5.

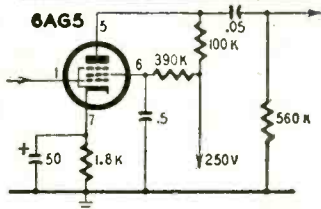
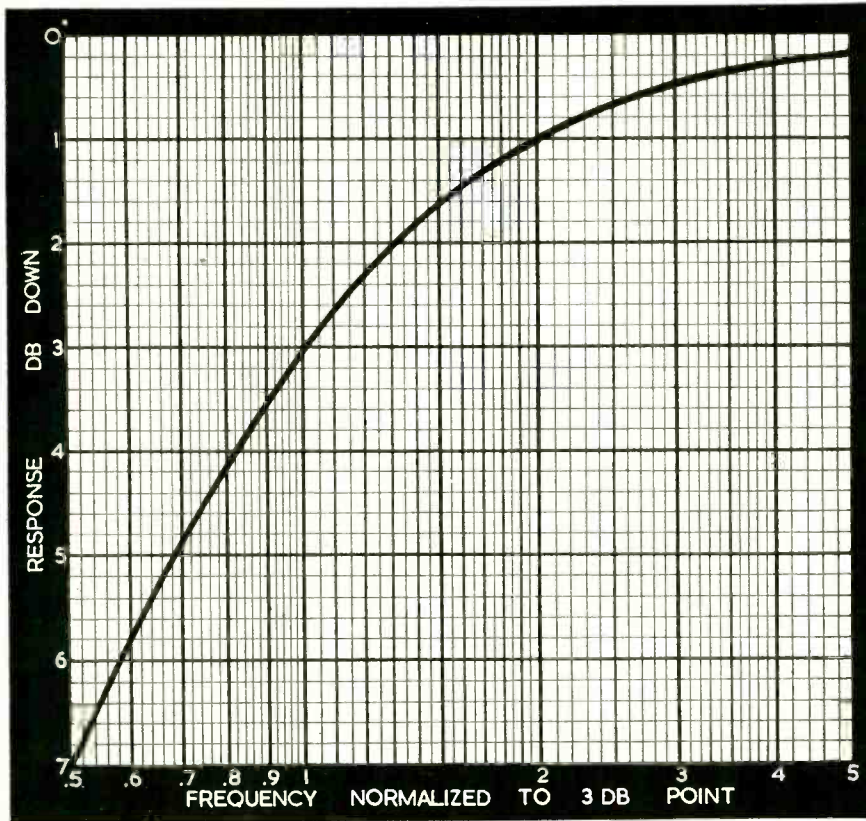

Fig. 2—R-C circuit using a 6AG5 pentode.

Fig. 3—Normalized curve aids in predicting response using various capacitors in circuit.



should have about 150 volts on the plate, or 100 volts drop across the 100,000-ohm resistor, placing the operating point near the center of the available swing. This represents a plate current of 1 ma. In each case the screen current is a little less than one-third the plate current. The screen voltage should be a little lower than the plate voltage to

assure stability, so a screen feed resistor more than three times the plate resistor value should be used. A 390,000-ohm unit was tried and found successful. The total cathode current will be about 1.25 ma. Now, we need a cathode resistor to supply about 1.5 volts bias, so the tube will handle 1 volt rms safely. A resistor of 1,200

ohms seems to be needed. Let's see how this compares with the middle column of data, the nearest to this operating condition.

The specified 100-ohm cathode resistor, with a total current of  $7.2 + 2.1 = 9.3$  ma, will produce a bias of 0.93 volt. If we assume the plate voltage is kept the same and the bias increased to 1.5, it is obvious that the current will get reduced to a little less than two-thirds or between 5 and 6 ma, instead of the 1.25 ma we assumed. So with a 1,200-ohm bias resistor, the current would be more than 1.25 ma, and the plate and screen voltages would be lower than prescribed, probably below 100 volts. We need more bias to handle the plate current and voltage.

Different values were tried, with 1,800 ohms giving the best result. Voltages measured with a vtvm were: grid bias (cathode to ground), 3.5; plate volts, 150; screen, 140. As the tube is operated fairly well into its curvature (approaching the plate bend cutoff) there is an appreciable second harmonic, but it did not matter in this application. We would guess that transconductance at this point is about a third of the quoted value as the plate current is about one-sixth the quoted value. This guess is arrived at by taking an average between the ratio and its square root: 6 is halfway between 3 and its square, 9. We would expect a change in plate current of 6 to 1 to be accompanied with a change of transconductance of 3 to 1, if the screen is changed in the same proportion. This turned out to be a good guess. The stage's gain measured 170, with a 100,000-ohm plate coupling resistor. This means the transconductance is 1,700, just one-third the quoted value of 5,100.

We could have figured this gain from the characteristic curves for the 6AG5, using a 100,000-ohm load line (see Fig. 1). For a 1-volt change in grid potential, from -3 to -4, the plate voltage changes from 40 to 210, representing a gain of 170.

The grid-resistor coupling to the following stage will cut down the gain. The grid resistor had been fixed by previous design figures at 560,000 ohms, so gain will be reduced by the effect of paralleling 560,000 ohms with 100,000 ohms in the plate circuit. As plate resistance is quoted as 500,000 ohms, and is probably much higher than this at the chosen operating point, we can for convenience ignore its effect. Placing 560,000 ohms in parallel with 100,000 ohms gives an ac load resistance of 85,000 ohms. Gain is reduced,  $0.85 \times 170 = 145$ .

To figure the low-frequency response, which must go down to 20 cycles, first we consider the coupling capacitor, which will introduce a 3-db loss when its reactance is equal to 100,000 ohms and 560,000 ohms in series, 660,000 ohms. A .02- $\mu$ f capacitor has a reactance of 390,000 ohms at 20 cycles, which will cause a loss of about 2 db.



# TRUE or FALSE Quiz for Audiophiles

By HERMAN BURSTEIN

Next, the cathode capacitor: First thing is to figure out how much the gain will change by not having it at all. With a gain of 145, an 1,800-ohm cathode resistor and a 85,000-ohm load, there will be a gain of  $\frac{145 \times 1.8}{85} = 3.1$

in the cathode resistor. This means that the grid-to-ground potential will be 4.1 times the grid-to-cathode potential, or the gain will be reduced by a ratio of 4.1 due to cathode feedback. When the cathode bypass capacitor has a reactance of 1,800 ohms too, there will be 3 db less than this maximum feedback. So there will be approximately 3 db feedback when its reactance is 1,800 divided by 4.1, or about 440 ohms. A 20- $\mu$ f capacitor has a reactance of 400 ohms at 20 cycles and contributes about 3 db loss in this circuit. Using a 50- $\mu$ f capacitor will keep its loss less than 0.8 db.

We have to know how much the screen capacitor will affect the gain. Without it, screen voltage will swing about the same as the plate voltage so the tube will have about the same gain as it would triode-connected. Gain of a normal triode is about 35 but, under this biased-back condition, it comes out to be about 15. This is somewhat of a guess at best because we have assumed plate and screen will have equal voltage swings, which may not be quite true. If it is not, we have no data to go on anyway. But if we estimate that the gain will drop 10 times by removing the screen capacitor, we have a fairly good basis for calculation. The feed resistor is 390,000 ohms so, when the screen capacitor's reactance is 390,000 ohms, we will have 3 db short of the maximum feedback (occurs when screen capacitor is removed) in the screen, while a reactance of about  $\frac{390,000 \text{ ohms}}{10}$ , 39,000 ohms will give a

feedback of about 3 db. A 0.2- $\mu$ f capacitor will have a reactance of 39,000 ohms at 20 cycles, so we should use about 0.5  $\mu$ f to give a loss of about 0.8 db.

If we use a .05- $\mu$ f coupling capacitor, the loss due to it will be about 0.3 db, so the total loss at 20 cycles is likely to be less than 2 db (0.8 + 0.8 + 0.3 = 1.9) with the circuit of Fig. 2.

Just a minute, someone will be saying, I know that when the reactance is equal to the resistance there is a 3-db loss, but how do you figure the loss for other reactance values? Well, we can use the response curve in Fig. 3 for this. This can be used to show either loss against frequency or loss against relative reactance. At twice the frequency, the reactance of a capacitor is halved and the loss is 1 db. So if we find the reactance is 0.25 of the resistance at 20 cycles, the loss will be the same as shown at 4 times the 3-db frequency, or 0.3 db.

Next month we will continue with a discussion of triode circuits and the problem of providing sufficient swing to drive output tubes. TO BE CONTINUED

**1. If a power amplifier rated at 100 watts produces 12.5 watts for an input of 0.5 volt, it will produce 25 watts for an input of 1 volt.**

*False*—It will produce 50 watts, because power varies with the square of the voltage.

**2. It is more important for phonograph turntable to rotate at a steady speed than at an accurate speed.**

*True* because most human ears can tolerate deviations from correct speed—for example, 34 instead of 33 $\frac{1}{3}$  revolutions per minute—of as much as 1%, 2% or even 3% without these deviations being perceptible or annoying. However, extremely small departures from steady rotation (wow and flutter)—well below 0.5%—are perceptible and annoying to most persons.

**3. Single-cone speakers are often superior to coaxial and two-way systems in the same price class.**

*True*—Mere division of the audio spectrum between two or more speakers is not sufficient for reproduction that is smooth, low in distortion and adequate in range. There are several single-cone speakers on the market which in these respects outperform multiple speaker systems at comparable total price. On the other hand, the ultimate in audio today is obtained by multiple-speaker systems that use specially designed units for each portion of the audio spectrum.

**4. Many AM broadcast stations meet high-fidelity requirements so far as frequency range is concerned.**

*True*—AM stations are not required to cut off above 5,000 cycles, as is often supposed. Many maintain flat response to 12,000 or even 15,000 cycles. However, most AM tuners cut off sharply above 5,000 cycles or thereabouts for design reasons and to minimize interstation whistle. Some high-fidelity AM tuners do maintain response well above 5,000 cycles, but unless the signal is a relatively strong one, noise and adjacent-channel interference may become unpleasant.

**5. Since afc (automatic frequency control) increases distortion, it is best to operate an FM tuner with afc off, if this is optional.**

*False* because, if anything, afc decreases distortion. The disadvantages of afc are a slight loss in sensitivity—in most cases much too small to be of importance—and difficulty in separating a weak station from a nearby strong one; that is, with afc on, the tuner tends to capture the strong signal rather than the weak one if the two are close to each other on the dial.

**6. The principal difference between professional and home tape recorders operating at 7:5 ips is in their high-frequency response.**

*False.* Many home recorders have high-frequency response extending as far as that of their professional brethren. The principal differences, for the same frequency response, are lower distortion and higher signal-to-noise ratio in the professional machine. Distortion includes that due to rumble and flutter in the transport mechanism.

**7. If a high-fidelity system contains a loudness control, then a gain control is superfluous.**

*False.* Maximum setting of a loudness control should correspond to the original level of the music and should provide flat response; as the control is backed down, bass should be augmented relative to the other frequencies. However, signal level will vary according to program source and other factors. Thus it is necessary by means of the gain control to restore the condition at which the maximum loudness control setting corresponds to original level.

**8. Sometimes 300-ohm TV ribbon (antenna lead-in) is used to connect a power amplifier to a speaker, often because it is flat and therefore convenient for running beneath a rug. However, since the impedance of the power amplifier and of the speaker is usually in the range of 4 to 16 ohms, it is not advisable to use 300-ohm wire for this purpose.**

*False*—TV ribbon line is perfectly suitable for connecting a power amplifier to a speaker. Because of its low capacitance per foot, it may be more suitable than other kinds of wire where a long run is required—except where low-efficiency speakers and high-wattage amplifiers are used at high levels, as power loss in small-diameter ribbon line may become excessive. Ribbon line may be used as its 300-ohm impedance does not have any effect unless it is terminated in a 300-ohm load.

**9. To minimize record wear, the tracking force of a phonograph stylus should be as light as possible consistent with its faithfully following the undulations of the groove. If one does err, it is better to err in the direction of slightly too little rather than slightly too much tracking force.**

*False* because too little tracking force will result in an increase in distortion because the stylus no longer completely follows the groove. Moreover, there will be greater wear than that due to slightly excessive tracking force because the stylus bounces around instead of adhering to the groove. END

# deluxe remote baby sitter

*Carrier-current system permits baby-listening from within the home or from several houses away*

By E. H. KAUFMAN



THE problem of how to get out evenings without the added expense of a baby sitter arises in every family with children. Some folks use a member of the family or a neighbor as a sitter; this is not always a happy solution. This article will describe a remote baby-sitting system which permits a neighbor to baby sit for you without leaving her home.

When you visit your nearby neighbors, you will be able to sit back and enjoy the evening without running back and forth to check the children. When possible, a direct line to a neighbor, an audio amplifier, microphone and speaker can't be beat, but in most cases the neighbor who will baby-sit for you is several houses away.

The solution is to use a carrier-current system. Although these systems have been discussed before, I do not consider existing circuits satisfactory for baby sitting. One reason is the possibility of the carrier shifting frequency over a period of several hours, causing a partial or complete loss of the signal at the receiving end. Second, a separate receiving unit must be built.

My circuit circumvents these problems by being crystal-controlled and operating in the broadcast band. It can be tuned in on almost any broadcast receiver.

The main defect of a carrier system is that reception is limited to houses on the same common side of the house

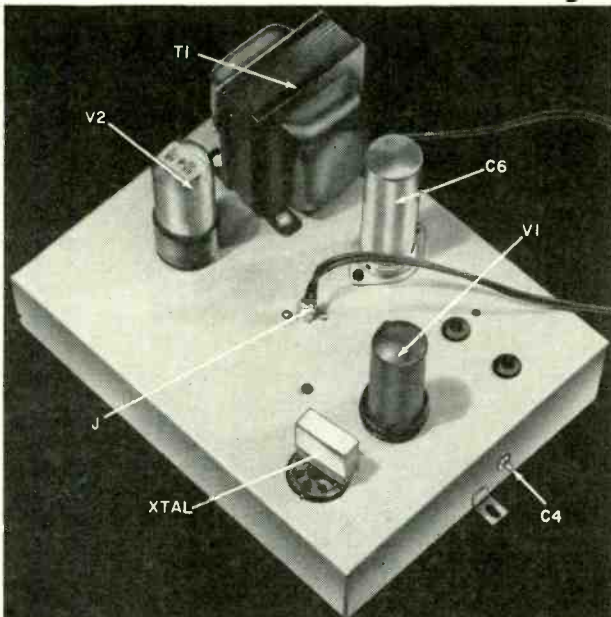

The carrier current transmitter. Note crystal plugged into octal socket.

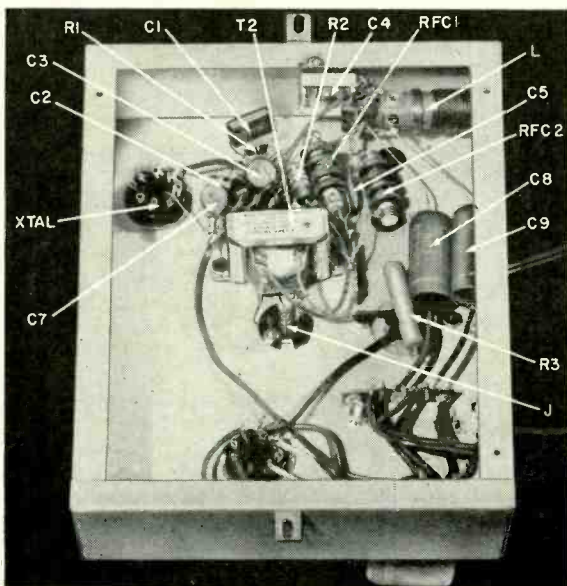

Parts layout under transmitter chassis.

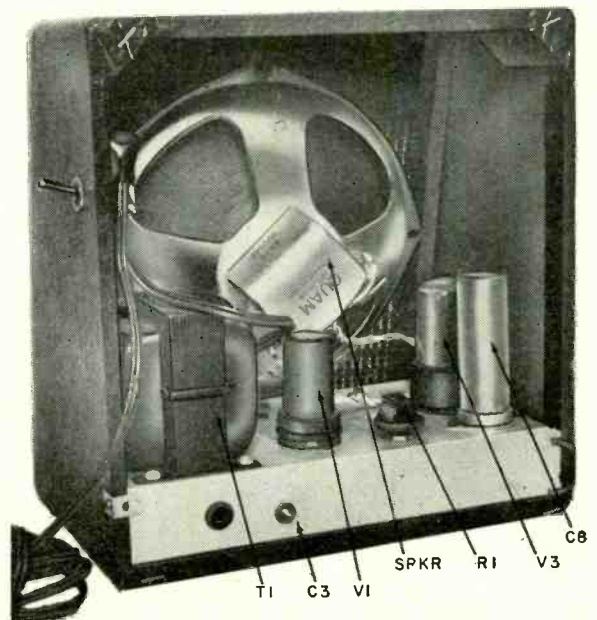

Compact receiver fits into speaker case.

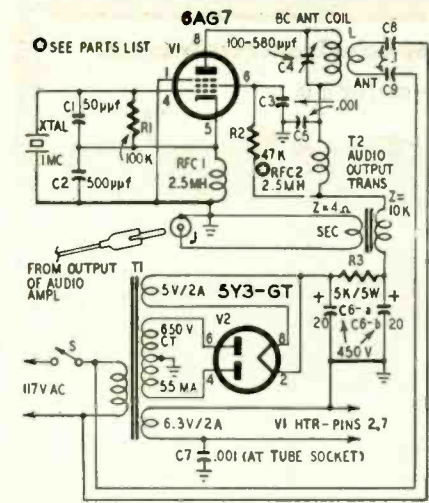

- R1—100,000 ohms, 1/2 watt
- R2—47,000 ohms, 2 watts
- R3—5,000 ohms, 5 watts
- C1—50  $\mu$ f, mica
- C2—500  $\mu$ f, mica
- C3, 5, 7—.001  $\mu$ f, disk ceramic
- C4—trimmer, 500  $\mu$ f (see text)
- C6—20–20  $\mu$ f, 450 volts, electrolytic
- C8, 9—.01  $\mu$ f, 600 volts
- J—phono jack
- RFC1, 2—2.5 mh, 200 ma, pie-wound, rf choke (Miller 4537 or equivalent). If transmitter is operated below 1 mc, use a higher value (5 mh) for RFC2, to prevent self-oscillation.
- L—antenna coil, 540–1,700 kc (Miller 43-A or equivalent)
- S—spst, toggle
- T1—power transformer; primary, 117 volts; secondary, 650 volts ct, 55 ma; 5 volts, 2 amps; 6.3 volts, 2 amps (Stancor PC8407 or equivalent)
- T2—output transformer; primary, 10,000 ohms; secondary, 4 ohms (Stancor A3879 or equivalent)
- V1—6AG7
- V2—5Y3-GT
- Crystal, 1 mc
- Chassis, 7 x 9 x 2 inches
- Sockets, octal (3)
- Miscellaneous hardware

Fig. 1—Circuit of the crystal-controlled carrier-current transmitter.

supply transformer. In many areas, however, the same transformer will supply at least a block of houses.

The transmitter circuit (Fig. 1) is a modified Pierce-Colpitts. It is not dependent on the electrode capacitance of the tube because two mica capacitors are connected across the crystal in parallel with the tube's grid-cathode and plate-cathode capacitances. Feedback is a function of the relative capacitance of the two micas and may have to be varied if the operating frequency of the circuit is radically changed from 1 mc.

A 1-mc crystal can be obtained from surplus sources for about \$4. New transmitting crystals can be obtained from electronic supply houses for \$4 to \$18. A 1-mc crystal avoids a direct radio-station frequency (Only four stations in North America operate on this frequency.—Editor) and is easily obtained.

Crystals with a pin size of .093 inch and 1/2-inch spacing will fit a standard octal socket. The circuit is straightforward and troublefree. About 1–2 watts of audio power is required to modulate the transmitter. Any audio amplifier will do the job. A radio with a phonograph jack can be used by plugging in a crystal mike, provided its gain is sufficient.

The best way of mounting L, a J. W.

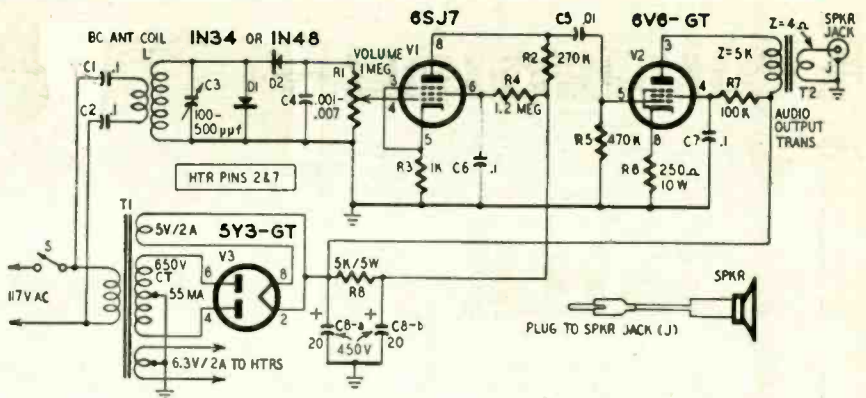

- R1—pot, 1 megohm
- R2—270,000 ohms, 1 watt
- R3—1,000 ohms, 2 watts
- R4—1.2 megohms, 1 watt
- R5—470,000 ohms, 1/2 watt
- R6—250 ohms, 10 watts
- R7—100,000 ohms, 2 watts
- R8—5,000 ohms, 5 watts
- C1, 2, 6, 7—.01  $\mu$ f, 600 volts
- C3—trimmer, 500  $\mu$ f (Arco 304M or equivalent)
- C4—between .001 and .007  $\mu$ f (see text)
- C5—.01  $\mu$ f, 600 volts
- C8—20–20  $\mu$ f, 450 volts, electrolytic
- D1, 2—1N48, 1N34
- J—phono jack
- L—antenna coil, 540–1,700 kc (Miller 43-A or equivalent)

- S—spst, toggle
- T1—power transformer; primary, 117 volts; secondary, 650 volts ct, 55 ma; 5 volts, 2 amps; 6.3 volts, 2 amps (Stancor PC8407 or equivalent)
- T2—output transformer; primary, 5,000 ohms; secondary, 4 ohms; 5 watts (Stancor A3877 or equivalent)
- V1—6SJ7
- V2—6V6-GT
- V3—5Y3-GT
- Chassis, 7 x 9 x 2 inches
- Phono plug
- Sockets, octal (3)
- Speaker, PM
- Miscellaneous hardware

Fig. 2—Three-tube no-drift receiver to be used with carrier system.

Miller type 43-A antenna coil, is to cut off the mounting lug and solder the coil directly to the lugs on the trimmer capacitor. To determine proper trimmer adjustment, place a dc voltmeter across the 5,000-ohm resistor R3. About 100 volts will be indicated. Screw the trimmer in and out; a broad point will be found where the voltage falls to below 50. The circuit is now properly loaded. Plug in a radio and turn to 1,000 on the dial (allow 15 minutes warmup time for stability). The system is now in operation.

#### Optional receiver

For those who would rather not use a radio as part of their system a carrier-current receiver circuit is shown in Fig. 2. The three-tube circuit eliminates receiver drift and provides considerable gain. More gain can be obtained by adding a 10- $\mu$ f 25-volt electrolytic capacitor across the 6SJ7

cathode resistor R3. Removing or decreasing the value of C4, the tone control capacitor, will also increase gain.

Observe proper polarity with the germanium diodes. The bypass diode increases amplifier gain and decreases noise and hash to a large extent.

The receiver's frequency range is about 430–1,700 kc. To receive frequencies below 430 kc add a 50–100- $\mu$ f capacitor across C3. If the receiver will not tune to a high enough frequency, replace C3 with a trimmer of lower capacitance.

The transmitter will operate satisfactorily at 530–540 kc if trimmer C4 is changed to an Arco 304M (320  $\mu$ f) and a 100- $\mu$ f mica is wired across it.

The receiver is very quiet without any appreciable 60-cycle hum. Compared to some broadcast receivers it seems to have better quality with excellent music reproduction. END



SALERNO

"Fine! Now a little more bass from the 15-incher in the corner!"

# LOW-NOISE TV BOOSTER

*This 4-channel unit brings in that color program. Helps to end weak color and confetti*

By J. R. LANGE, K9ARA

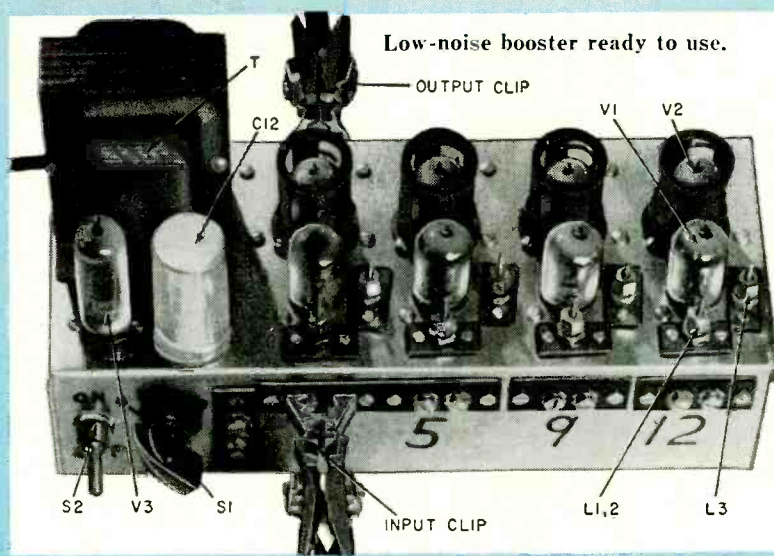

THE growing use of color TV sets has created new interest in improving fringe area reception. The fringe for good color reception seems to be closer to the TV transmitter than for black and white. We recently purchased a color TV set before local uhf stations were equipped to originate or relay color programs. Nearly snow-free black-and-white reception was obtained from Milwaukee and Chicago vhf channels 4 and 5 but very little color and lots of confetti was present during color broadcasts. Little could be done to the antenna so several boosters were tried using 6J6 and 6BZ7 tubes. Some improvement, but not enough to be really significant, was obtained on channel 5 using a hot 6BZ7.

The noise figure or snow contribution of a booster or TV tuner rf stage is mainly determined by the tubes. The higher the tubes' transconductance, the lower the noise figure. Common tubes, such as the 6J6, 6BK7-A, 6BQ7-A, 6BZ7, 6BZ8, etc., now used for TV tuners, boosters and distribution amplifiers, have transconductances of 6,000 to 9,000  $\mu$ mhos. Some miniature tubes such as the 6AJ4, 6AM4 and 6BC4 are rated at about 10,000  $\mu$ mhos. Since the first or grounded cathode stage of a vhf cascode rf stage contributes most to the noise figure, a more expensive (\$8 to \$15) tube can be used for the first stage and a less expensive one for the grounded-grid stage.

I built a channel-5 cascode TV booster with a Western Electric WE 417-A/5842 followed by a G-E type 6AJ4. The 417-A has been popular with amateurs on the vhf bands and has a low noise figure because of its 20,000-25,000- $\mu$ mho transconductance. The color picture improvement was surprising. Color confetti was reduced. Color sync and saturation were improved. The booster also improved all black-and-white sets it was tried with.

The requirements of wide-band microwave if and video amplifiers have led to the development of high-performance pentodes such as the WE 404-A/-

5347 and Amperex and Mullard E180F-/6688. They feature a close-spaced grid and cathode structure similar to that of the 417-A. When triode-connected, with screen tied to plate, a grounded-cathode stage with a transconductance of 20,000  $\mu$ mhos can be obtained. Noise figures are nearly as low as with the 417-A.

Our four-channel vhf booster was built with triode-connected 404-A's and E180-F's in the input stages of channels 4, 5, 9 and 12, and 6AJ4's in the grounded-grid stages using a series dc cascode circuit. The 6AJ4 is a good grounded-grid amplifier and has a heater-to-cathode voltage rating sufficient for use in the series dc or direct-

coupled cascode circuits. It is moderately priced and can handle the plate current required for proper operation of the first stage. The presence of the suppressor grid in a pentode input tube causes little increase in noise, but does cause some loss of gain when the 404-A is used on channels 7 to 13. This is probably due to the internal connection of the suppressor to cathode and the common-cathode lead inductance. The E180F suppressor can be separately grounded and the two cathode leads doubly bypassed to give better high-band gain.

If a booster is to be constructed, decide what input tube type is to be used and what form the booster will take

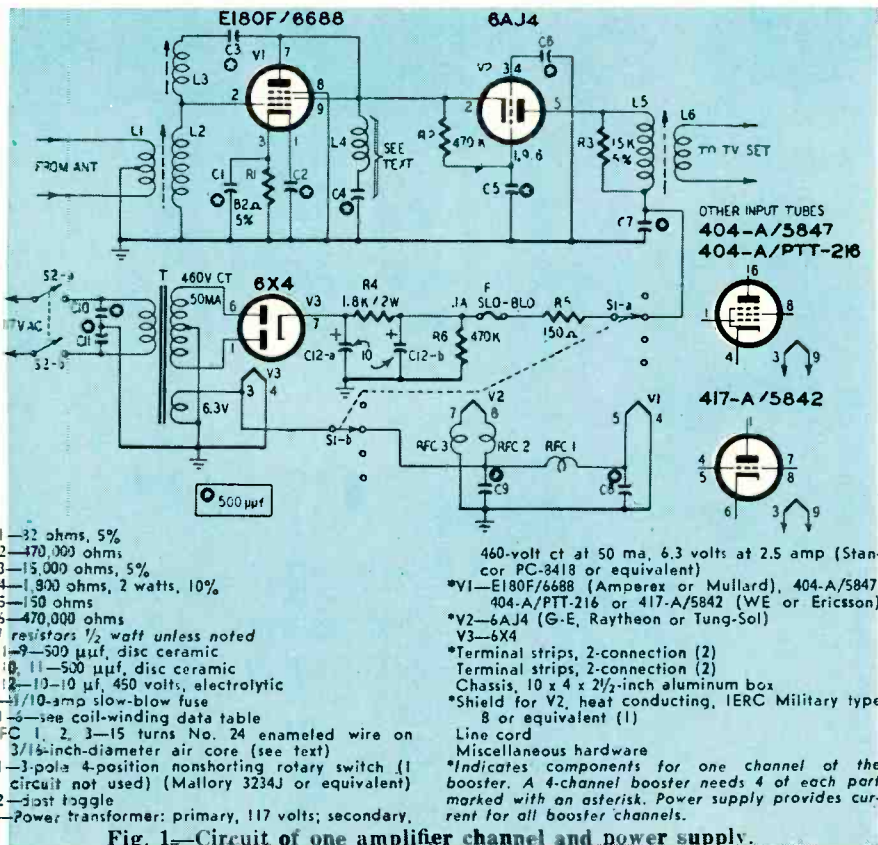
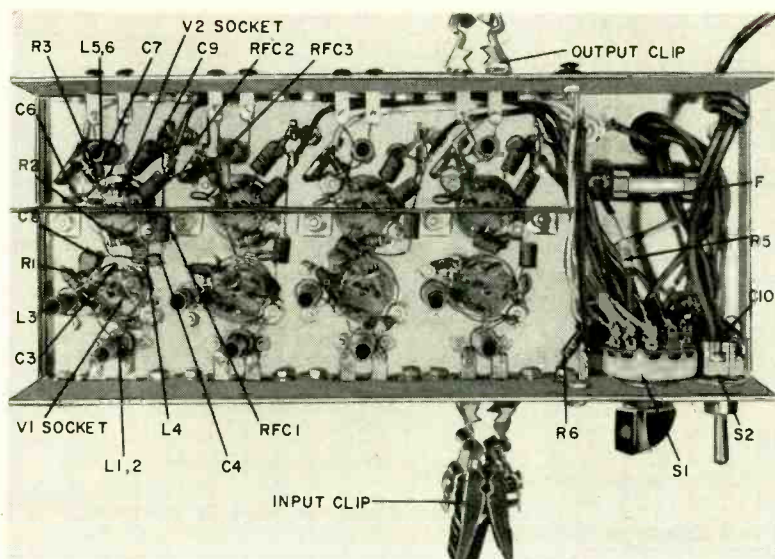

Fig. 1—Circuit of one amplifier channel and power supply.



Bottom view showing parts layout of one channel and power supply.

for best utility and appearance. For high-band channels the 417-A, E180F, and 404-A (in the order named) are best for gain. The gain with the 404-A is still high enough so that noise figures of all three tubes are comparable and around 4.5 db. Low-band gains are nearly the same, and noise figures of about 3 db can be obtained. These tubes are usually not sold locally but are obtainable from several mail-order surplus dealers. Make sure tubes are new; not used or rebranded. E180F's are obtainable from Amperex Electronic Corp., Hicksville, N.Y., and from Amperex or Mullard distributors. The 404-A and 417-A/5842 are also obtainable from Ericsson (State Labs, 649 Broadway, New York, N.Y.) at list prices. Special-purpose tubes may often be ordered from dealers who do not list them in their catalogs. Be sure to specify the 417-A/5842 completely to avoid getting a WL417-A surplus klystron.

### Building the unit

The booster shown in the photographs was built for use on top of or alongside the TV set. It was built into a 2½ x 10 x 4-inch Channel Lock aluminum box and has a self-contained power supply. Fig. 1 shows the circuit for a single channel. Four of these are combined to form a four-channel booster. The power supply is as in Fig. 1. Plate and heater power can be switched to any of the four peaked single-channel amplifiers. Input and output leads are quickly connected using clothespin type antenna clips. A straight-through connection is provided for local vhf or uhf converter output.

The inside view of the booster (see photos) shows the suggested circuit layout. Sockets are oriented with plate leads toward the output. A sheet-aluminum shield is placed across the 6AJ4 socket (passing between pins 3 and 4 and 8 and 9) to prevent oscillation. Lead lengths of the input tube cathode bypass and the 6AJ4 grid bypass capacitors should be as short and direct

to a chassis ground as possible. The input and neutralizing coils are insulated from the chassis.

The tubes should be shielded from each other to keep the grounded-grid stage stable. The ordinary JAN type shield causes high bulb temperatures and for longest tube life should be avoided. The four-channel amplifier has heat-conducting shields on the 6AJ4's. (We used IERC military B type shields made by IERC, 145 Magnolia Boulevard, Burbank, Calif.) It is recommended that they be used on both tubes.

Besides the input tube the input coil has an important effect on the booster's noise figure. The coil-winding data table gives coils that are overcoupled past the point of maximum gain so as to present to the tube the impedance giving lowest noise figure. The four-channel booster uses ¼-inch-diameter coil forms from a microwave or radar rf strip. Commercial ¼-inch-diameter forms such as the Cambridge Thermionic Corp. LS-6 or the James Millen 69048 are equivalent. High-frequency powdered-iron cores coded white should be used. Lower-frequency cores will lower the coil Q and may increase the noise figure.

The low-band input, neutralizing and output coils are wound tightly with No. 28 enameled wire. Adhesive tape cut into ½-inch strips will help to hold the ends while winding. Bend the first inch of wire at a right angle to the

direction of winding and lay on the form parallel to the axis. Wrap a small length of tape several times around the form and the lead near the bend. Wind the coil, keeping the turns tight. After the last turn, bend the wire at right angles to the windings and parallel to the axis of the form. Tape down like the starting end. Leave 1-inch leads. Coat the winding and tape with a good coil dope such as Q Max or polystyrene cement. Model-airplane type cements should not be used. They reduce coil Q.

The input coil and output windings L1 and L6 are similarly tightly wound, in a reverse direction, over the grid and plate windings after they are dry. When halfway through the input winding, scrape 2 inches of the wire bare, fold over, twist and tin with solder so that a 1-inch twisted lead for the center tap sticks out. Finish winding, tape the end and apply another coat of coil cement. Check with an ohmmeter to make sure the two windings are not shorted.

Coils for channels 7 to 13 are wound with No. 24 enameled wire. This is easily done after the forms are mounted on the chassis. The heater and interstage rf chokes are tightly wound over a 3/16-inch-diameter rod or drill shank. By scraping the enamel off, tinning with solder and bending the leads before sliding out the rod, the choke will not be distorted when ready to solder in the circuit. The interstage choke for channels 7 to 13 is wound using the leads of capacitor C4, spreading turns apart one turn width.

If space is a problem or if a booster for only one channel is needed it can be built into a 2 x 2 x 4-inch aluminum box with power taken from the TV set. It could then be easily concealed. An antenna-top version can be enclosed in a 3 x 4 x 5-inch weatherproof box and power can be sent up externally. The bandwidth of a single-channel unit can be widened to cover channels 7 to 13, or several low-band channels such as 2, 3, 4 or 4 and 5. A sweep generator and oscilloscope should be used to check alignment. Single-channel boosters can be peaked using a TV set and station signal if the coil winding data given for the desired channel is followed.

### Booster alignment

The booster's tuning can be checked best by using a sweep generator, oscilloscope and 300-ohm balanced detector

Booster's channel-9 circuit undergoing a noise test.

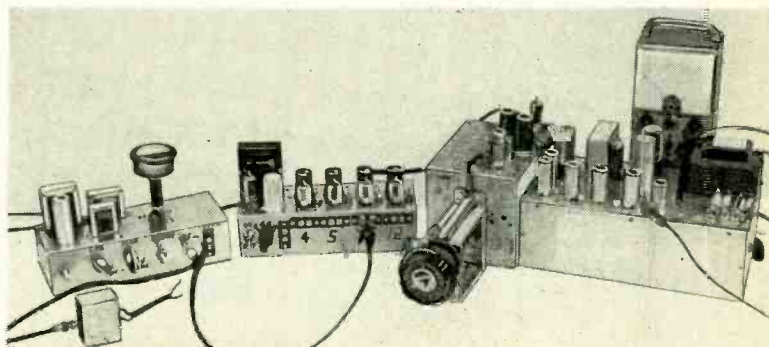

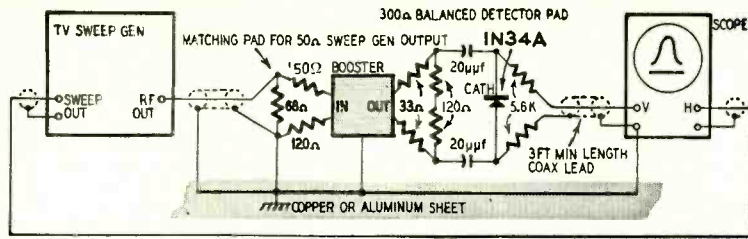

Fig. 2 (above, left)—Alignment setup and curve for tuning the booster's channels.

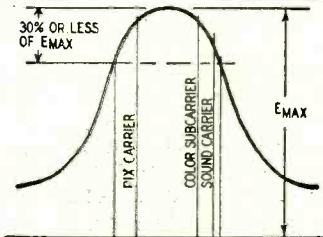
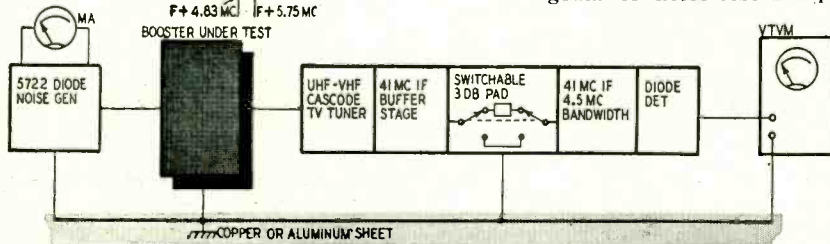

Fig. 3 (below)—Block diagram of noise-test setup.



TV Channel	NOISE-FIGURE COMPARISONS			
Uhf-Vhf Cascode TV Tuner Alone	4	5	9	12
Commercial Push-Pull 6J6 Tunable Booster	5.3 db	5.1 db	7 db	7 db
Commercial Single-Channel 6BZ7 Cascode Booster	5.3 db	5.5 db	6.5 db	6.4 db
404-A, E180-F, 6AJ4 Cascode Booster	2.7 db	4.4 db	4.3 db	4.8 db
417-A, 6AJ4 Cascode Booster	2.7 db	3 db	4.3 db	4.8 db
		2.9 db		

pad as shown in Fig. 2. The input circuit response can be checked by disconnecting L5 from the plate of the 6AJ4 and shunting the 15,000-ohm output damping resistor with a 150-ohm resistor. Touch a rf crystal demodulator probe, connected to the scope, to the plate of the 6AJ4 and observe a single peaked curve. This curve should be centered, using the input and neutralizing coils, on the desired TV channel. The number of coil turns may have to be changed if the response cannot be centered. In some instances the overall response curve may be too narrow or the TV tuner may reflect an impedance higher than 300 ohms to the booster. When the booster is connected to the TV set then, the bandwidth is actually narrower than the observed response and may be contributing to instability. In this case, bandwidth can be widened by increasing the number of turns on L6 or reducing the 15,000-ohm plate damping resistance.

Bandwidth can be widened to give a flat response over several TV channels on either side of a single channel picked according to coil-winding data. This requires that the input and output windings L1 and L6 be wound below and separated 1/32 to 1/8 inch from the grid and plate windings L2 and L5; and 3 to 30-μf trimmer capacitors are placed across L1 and L6. The input response is first adjusted and then the overall response. In adjusting the double tuned coils, the coil spacing will mainly determine the bandwidth, the capacitor will tilt the curve and the core is used to maximize the curve amplitude in general. There is some interaction.

Data on the noise figure of the four-channel and other boosters measured over a 4.5-mc if bandwidth is shown in Fig. 3 along with the test hookup. A 1-db reduction in noise figure gives a noticeable reduction of snow. A 2-3-db reduction in noise figure, possible with this type of booster in front of the average cascode tuner, gives a snow reduction equivalent to stacking the receiving antenna or doubling the TV transmitter power.

When the booster is complete, final adjustments can be made using the TV signal and TV set. Pick a time when the signal is weak, but not fading, and external interference is at a minimum. Connect the booster between the antenna and TV set and make sure the input leads, output leads and power cord are separated from each other.

Use as short a lead as possible between the booster and TV tuner. After the booster has warmed up, adjust the output coil for maximum picture contrast and the input and neutralizing coils for least picture snow. Note the snow content of dark picture areas while tuning the booster. In some cases, particularly on channels 7 to 13, wrapping a 4-inch square of aluminum foil around the input lead and sliding it along 1 to 4 feet from the booster will improve the picture. Readjust or remove for other channels.

If the booster oscillates (indicated by a white or torn raster on the TV screen), turn off the booster, retune the neutralizing coil until no oscillation occurs when the booster is turned on and warms up again. Because of the high gain of this booster, oscillation may be present when it is mounted near the antenna and radiation from the long output lead is picked up by the antenna. In this case 300-ohm shielded line should be used between the booster and TV set. If a 75- to 300-ohm transformer is connected near the TV set, coaxial line can be used. For coupling to a 75-ohm coaxial line, the number of turns on L6 should be half the number given by the winding data, and one end is grounded.

If the booster gives little or no picture improvement, check all operating voltages. The plate current should be at least 20 ma with a 404-A or 417-A input tube and 16 ma with a E180F. Currents much higher than 20 ma will shorten the life of the 6AJ4. Also disconnect the input-winding center tap from ground and check for a short between L1 and L2.

Switching inputs and outputs in addition to plate and filament power is possible as long as the input and output leads and switch contacts are physically separated. A three-gang six-pole non-shortening two-or-more-position steatite insulated rotary switch would be satisfactory. (These switches are made by Mallory and Centralab.) The middle gang can be used for plate and heater switching and to separate the input and output gangs. This kind of switch takes up a lot of room and will leave room for three channels only. END

Coil-Winding Data Table

TV Channels	L1		L2		L3		L4		L5		L6	
	Turns	Wire*	Turns	Wire*	Turns	Wire*	Turns	Wire*	Turns	Wire*	Turns	Wire*
2	7½	No. 28	11	No. 28	21	No. 28	20	No. 24	14	No. 28	6	No. 28
3, 4	6½	No. 28	9	No. 28	17	No. 28	16	No. 24	12	No. 28	4½	No. 28
5, 6	4½	No. 28	6	No. 28	13	No. 28	12	No. 24	9	No. 28	3½	No. 28
7, 8	3½	No. 24	3	No. 24	4½	No. 24	4½	Use C4 leads	4½	No. 24	3	No. 24
9, 10	3	No. 24	2½	No. 24	4	No. 24	4½	Use C4 leads	4	No. 24	2½	No. 24
11, 12, 13	2½	No. 24	2	No. 24	3½	No. 24	4½	Use C4 leads	3½	No. 24	2½	No. 24

\*All coils use enameled wire except coil L4, channels 7-13, which uses the leads of C4.  
 1. L2, L3 and L5 are tightly wound on 1/4-inch-diameter slug-tuned coil forms such as James Millen 69048-B with No. 19 mix core (coded white) or Cambridge Thermionic Corp. LS-6 with 20063-D core (coded white).  
 2. L1, center-tapped, and L6 are reverse-wound tightly over L2 and L5, respectively.  
 3. L4 is 3/16-inch-diameter air-core, tightly wound choke on channels 2 to 6 and is wound 3/16-inch diameter, with leads of C4 spaced 1 turn, on channels 7 to 13.



By ROBERT B. COOPER, Jr.

**B**Y now, almost everyone has read or heard something about the International Geophysical Year (IGY). The IGY is an 18-month period during which 65 nations will study the actions of the earth and solar system. This period is being used to gather facts more than to study the earth—huge storehouses of facts which scientists will be able to study for generations to come.

One of the fact-gathering programs (there are 11 in all) now being investigated—is concerned with the ionosphere and—to be more specific—the effects of the ionosphere on vhf and uhf radio-television signals entering it. At present, amateur radio observations are being used in this study and a plan is underway to include TV dx reports in the program. This is where you come into the picture.

The ionosphere study group is looking for consistent, monthly reports on any forms of unusual TV reception that might be linked to the ionosphere. If you feel that you might fit into this proposed program, drop me a line outlining your general dxing habits (time of day spent dxing, greatest reliable range, experience and a fairly complete description of your equipment). If enough interest is mustered for this project, I will attempt to carry the ball from here.

#### Why IGY now?

The IGY period began on July 1, 1957. This date was not picked on a haphazard guess, nor was it a matter of international politics. The predicted peak of the 11-year sunspot cycle, expected to fall within the 18-month IGY period, was the determining factor. Past experience has shown that definite correlations exist between high sunspot numbers and various effects here on earth—such as radio propagation, aurora and possibly weather conditions. To sum up, we can expect more in the way of excellent and unusual dx conditions during the IGY, than in any similar recent period.

#### The summer was unusual

In our spring TV dx columns, we discussed aurora skip, not so much as a means of logging new stations, but more as a means of noting the effects of one of nature's biggest mysteries on the TV channels.

Aurora, concentrating as it does near the magnetic north (and south) pole, is usually limited to areas along the Great Lakes and into New England. Not being a true north-south phenomenon (due to the location of the mag-

netic poles), we find locations such as San Francisco, Calif., and Miami, Fla., about the same distance from the auroral center.

You might imagine how unusual it would be to see aurora from Miami. But it happens or at least should have happened on the evening of Sept. 4, when I noted auroral reception on channels 2, 3, 5 and 6 from Fresno, Calif. Reception peaked to the northeast and consisted of the usual hazy, floating lines, not seeming to be either vertical or horizontal in component. No identification was possible on any of the channels.

#### Ground wave runs wild

September is the traditional month for long-haul tropes (ground wave) reception, but various periods in July did their best to erase traditions. Along the Great Lakes, down the Mississippi and throughout the western Gulf, ground wave overstepped its boundaries with every change of weather.

The best dates would seem to have been July 3-8, and July 15-19. Of the more outstanding work done, Dave Janowiak of Milwaukee, Wis., managed to log 59 stations in a single 24-hour period! And all of this via tropes, no skip involved.

Paul Swartz and Carlton Howington, central Ohio dx'ers, found ground wave open to 690 miles for high-band loggings on July 3, 17 and 18.

Uhf dx-pert, Carl Lupton of Shelbyville, Ill., noted tropes to 780 miles on July 8, with high-band Texas Gulf stations rolling through. But the corker came on July 16-17, with 18 uhf stations seen.

Along the Gulf coast, dx'er Ray Escoffier, New Orleans, and Ed Bourgeois, Norco, La., report frequent tropes openings to the West Texas high-band stations (800 miles) and north to the Great Lakes.

The nation's top TV dx'er, Bob Seybold, of Dunkirk, N. Y., took advantage of conditions to push his station total to 310 stations in 5 years of watching. Some of his outstanding results read as follows: July 18, tropes to 500 miles, on both vhf and uhf, with 16 uhf stations logged. July 19, the best uhf conditions Bob has ever witnessed. 510 miles the farthest, and stations logged on 18 uhf channels (20 stations in all), 18 of which were over 125 miles distant!

Predicting TV dx conditions on a general basis can be a problem, and even a little risky. It's not too often that we are 100% accurate.

But, TV'er John Broomall, Due West,

S. C., read of our Perseids meteor shower prediction in the July column. Noting that it would peak at 0200, Aug. 12, John decided to have a go at this burst reception stuff. The result? His 60th TV dx station, KRLD, logged at precisely 0200, Aug. 12, on a nice long burst. Anyone curious about the weather this Christmas?

#### Predictions

For the period of Nov. 1-Jan. 1, E-skip reception should follow closely on the heels of magnetic storms (and the resulting aurora). Watch your northern skies for that eerie glow, signifying northern lights, and watch your newspaper for news of strong magnetic storms. E-skip openings will be most frequent south of a line drawn between San Francisco, Calif., and Norfolk, Va. Gulf Coast dx'ers should notice a major upswing in openings to Mexico City and Guatemala, beginning about Nov. 1. All Es openings will be most likely to occur between 1500 and 2000 local time.

F2 layer reception will probably be limited to dx'ers with some type of converter or adapter which enables them to receive TV broadcasts between 40 and 55 mc, originating from Europe. Skip is not too likely to get as high as our American channels, except for brief instances on peak days.

Tropes reception will already have tapered off considerably from summertime levels and in general will be weak and spotty in nature for the next four months. Areas along the Gulf and Great Lakes will have the best tropes results.

Meteor showers are fairly frequent throughout November and December. One major shower (the Geminids) occurs Dec. 10-14, with outstanding results coming from 1900 to 0200, local time. The Taurids, a minor shower, occurs Nov. 3-10 and promises good early-morning reception. Other showers are the Leonids, Nov. 15-17, and Ursids, Dec. 22. For further meteor-shower information, I suggest you consult your local library for a current copy of *Sky and Telescope*, in which monthly information about showers is given.

#### Report forms

Free. That's right, free. Sharp bicolor TV Dx report forms, made especially for reporters to the RADIO-ELECTRONICS TV Dx Column. Be the first in your group to have a set. Just send your name and address to TV Dx Column, 154 West 14 St., New York 11, N. Y. END

  
**TV Service**  
**CLINIC**  
 conducted by  
**ROBERT G. MIDDLETON**

**T**HE color bar generator is about as basic an instrument on the modern service bench as a vom or vtm. A color bar generator is something like an automobile—after a certain amount of mileage, we had better have a tune-up if we expect it to serve us as expected.

There are several kinds of color bar generators and, of course, service and maintenance procedure differs for the various types of instruments.

**Generator types**

First of all, we must recognize the difference between a color bar generator, which provides true colors, as distinguished from a color-difference bar generator, which provides simulated colors.

We must also recognize the difference between a color-difference bar generator and a continuous-running subcarrier generator. If you connect the output from a simple rainbow generator to a wide-band scope, a sine-wave pattern is obtained, as shown in Fig. 1. We

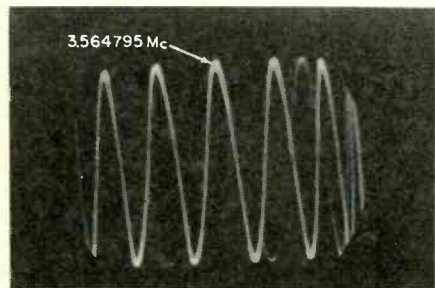

Fig. 1—The output of an unkeyed rainbow generator, seen on the screen of a wide-band scope.

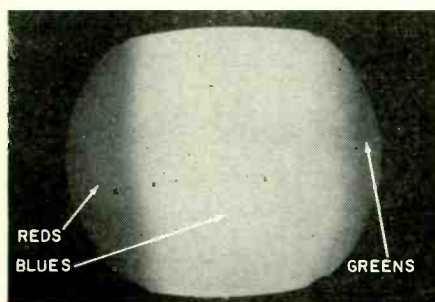

Fig. 2—Unkeyed rainbow pattern, locked in color sync on the screen of a color picture tube.

often refer to this signal output as a continuous subcarrier, but it is really a continuous *offset* subcarrier—its frequency is (or should be) 3.564795 mc, which is one horizontal-scan interval less than the color subcarrier frequency of 3.579545 mc.

Such generators are usually crystal-controlled, with a small trimmer capacitor shunted across the crystal to obtain the exact operating frequency. When the crystal is operating on frequency, we obtain a rainbow pattern on the screen of a color picture tube, as shown in Fig. 2. When the crystal is operating far off frequency, we obtain color sync breakup, as shown in Fig. 3.

The easiest and most straightforward way of checking the frequency of the crystal oscillator is with a good heterodyne frequency meter. If you operate this type of generator slightly off frequency, the pattern will not break color sync in a normally operating receiver, but a pull occurs, which causes the pattern to shift horizontally on the screen of the color picture tube, thus giving incorrect information.

The more elaborate form of color-difference signal is keyed into discrete bursts and horizontal sync pulses are provided. Frequency requirements are either 3.564795 mc, or 3.579545 mc, depending upon whether the generator is designed to operate at the true subcarrier frequency or at sidelock frequency. Fig. 4 shows the waveform from a generator of the first type and also illustrates a further service requirement: the peak-to-peak voltage of the sync pulse should be equal to the peak-to-peak voltage of the burst. Service controls are provided for this purpose and



Fig. 3—Appearance of a rainbow pattern which is out of color sync.

a wide-band scope is the most practical indicator to utilize in this regard.

The peak-to-peak voltage of the chroma bar is usually made equal to the peak-to-peak voltage of the burst, although some generators run the chroma bar voltage at a somewhat higher level. A service control is provided.

Space does not permit further coverage of service and maintenance procedures for color bar generators in this installment, but we will discuss more practical pointers another time.

**Horizontal pull**

*On a Philco deflection chassis No. D-201, there is a pull horizontally at the bottom of the picture, which appears to be a vertical height trouble until a test pattern is displayed. Then it seems to be a horizontal linearity problem. I have checked everything associated with the vertical and horizontal circuits except the horizontal output transformer.—M. T. S., Longview, Tex.*

This report sounds suspiciously like electrolytic-capacitor trouble. We would suggest that you check the electrolytic associated with the sweep and sync for capacitance value and power factor.

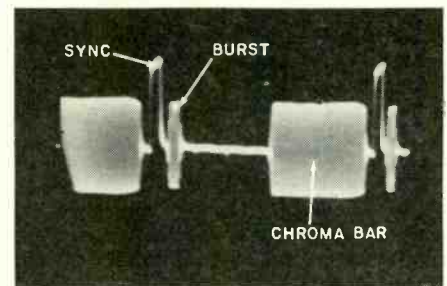

Fig. 4—Accurate reproduction of this color TV waveform requires the vertical amplifier to have the same response at the color burst frequency as it has at the horizontal sync frequency.

Replace any of these electrolytics that fall below standard, and it is probable that the trouble will clear up.

**Poor fine detail**

*I have a Magnavox 27-inch receiver, chassis CT-358BA. I don't obtain fine detail and on certain channels whenever there is a vertical line in the picture, such as a door frame, it looks ragged. I realigned the set but still don't obtain fine detail.—A. K., River Edge, N. J.*

We would suggest that part of this trouble may be due to poor alignment, there is also a definite possibility of overloading and clipping in the sync signal, with possible entry of video camera signal into the sync channel.

Before realigning the receiver, I would suggest that you check the coupling capacitors in the if and video amplifiers for leakage. Also check the coupling capacitors in the sync channel. Replace any capacitors that show even a small amount of leakage.

This will probably serve to make the picture straight and, if the detail is still poor, a careful check of the alignment would be justified. Start with the tuner and follow through with the if ampli-



fier. Then, check the combined rf-if response curves on the various channels to make sure that you don't have a mixer-regeneration problem on your hands.

Finally (and this is very important), sweep the video amplifier and make sure that you are getting full 4-mc bandpass through the video amplifier circuits.

### Vertical roll

*I have been troubled by what appears to be a heater-cathode short in one of the tubes of an Admiral 24E1 chassis. A bright horizontal line appears across the upper third of the raster, accompanied by a vertical roll that can't be locked. The vertical hold control cannot be turned to make the picture roll down, only upward. The capacitor marked C1 on the schematic showed signs of leaking electrolyte, but all sections check OK on a capacitor checker.—K. K. M., Germany*

This trouble is evidently one of those capacitor failures that doesn't show up on routine checks. Substitution tests are advisable in a situation of this kind. You should start by replacing the multiple-section electrolytic that you mention, because there is possible leakage between sections, which would not be caught on a test of the individual sections.

As we all realize very well, the capacitor that looks the worst is usually not the culprit. So, if replacing the obvious unit does not do the trick, try substituting the other multiple units.

### Horizontal curve

*I have had several service calls on a Philco 22D4162. This set has a very bad S-shaped weave. I have replaced the sync separator 6CS6, horizontal afc 6AL5 and horizontal multivibrator 12AU7-A. Replacement cleared up the trouble for a while. The curve in the raster appears after the receiver has been operating for some time. All the dc voltages have checked out correctly. The trouble cannot be cured by adjustment of the horizontal hold and horizontal oscillator controls.—C. F. J., New York, N. Y.*

This trouble could be due to heater-cathode leakage in the 6AM8 video detector. You do not mention whether the S-shaped weave is a 60- or 120-cycle pattern. This could be a good guidepost in weeding out possibilities.

I suggest that you first make sure that you have no tubes with heater-cathode leakage in the signal circuit. Then, if tube replacement does not clear up this trouble, go to work on the electrolytic capacitors. Check for low capacitance values, poor power factor and leakage between sections.

### Intermittent sync

*I am working on two TV receivers that are giving me a lot of trouble. They appear to have about the same kind of trouble. They operate OK for several*

*days and then go out of sync. One is a Westinghouse V2243-1 and the other is a G-E model 14007.*

*The G-E will start with fuzzy edges like piecrust, but with smaller dips and then it will flip and display horizontal bars or three or four pictures horizontally.*

*When the Westinghouse chassis is acting up, it tears in different spots of the raster and occasionally goes out of horizontal sync.—F. P., Westfield, Mass.*

Again, this report is typical of the difficulties which occur when common electrolytic bypass or decoupling capacitors have become marginal. It is most likely that one or more of the electrolytic capacitors associated with the horizontal sync section have lost a substantial fraction of their original capacitance and have developed a low power factor. Also, do not overlook the possibility of leakage between sections of a multiple electrolytic.

Electrolytic capacitors have different characteristics when hot than when cold and their characteristics change after a period of operation as compared with their condition after a nonworking period. Any tests should be made after the receivers have been in operation for several hours.

### Vertical rolling

*I received a G-E 21C200 chassis with a case of picture rolling. The picture rolls slowly up or down until the vertical-hold control is adjusted. Then, in a few minutes, the picture will start to roll again. The owner informed me that the trouble started after they had a new picture tube installed. All dc voltages seem correct, allowing for the high line voltage which we have here.—W. R. M., Newton, N. J.*

It is evident, of course, that the vertical oscillator is changing frequency in a high or a low direction from time to time. However, because the picture rolls up, it also is evident that the vertical oscillator is not being locked in sync at times. This lack of vertical-sync lock is probably the root of the trouble.

The circuit arrangement of this receiver is such that the condition of the picture tube could affect sync action. I suggest that you first eliminate this possibility by checking with a test picture tube. If this clears up the trouble, a fault is indicated in the picture tube in spite of the fact that it is quite new.

But if this does not correct the vertical sync hold, as is likely to be the case, you will have to dig deeper for the trouble. There is a certainty that you will find little or no vertical sync pulse at the output of the integrator plate (junction of R302 and C302). So, the problem is going to be to find out why this pulse is not present (during the time the picture rolls up). In making this type of test, do not confuse the vertical sync pulse with the kickback pulse from the vertical oscillator. If there is any doubt on this point, pull

the vertical oscillator tube and substitute a dummy tube with all but the heater pins cut off. This will permit you to check the pulse from the integrator without interference.

Check the integrator plate and its associated circuit components. Trace back with the scope to find out where you are losing the vertical sync pulse. This probably sounds peculiar, but it is not impossible for a brand-new integrator plate assembly to be defective.

### Poor sync

*A Bendix 21K9 chassis has poor vertical and horizontal sync, with sound and picture OK. The horizontal locking-in range is critical. Vertical lock-in is also critical. There is a horizontal pull in the picture about 2 inches from the top and varying the contrast control tends to straighten out the pulling. Changes in cameras or background will usually cause severe picture pulling, with buzz in the sound, after which the picture will stabilize. Vertical linearity is poor, with compression at the top.*

*The 6W6 runs extremely hot. The B-plus voltage at the cathode of the 6W6 measures 185. The set has too much width, which cannot be reduced, and the width control smokes whenever it is turned completely counterclockwise. The aqc voltage at the plate of the 6AU6 keyer is -36.—R. C., Chicago, Ill.*

In response to your query, it appears quite likely that the horizontal output tube is generating too much sweep voltage. This follows from the fact that the 6W6 runs hot, and that the B-plus voltage at the cathode of the audio output tube is high. Also, the output from the keyer tube is high, and the picture width is excessive, which all points to the same trouble.

You should find 60-volt (peak-to-peak) drive at the grid of the horizontal output tube. This can be quickly checked with a calibrated scope. Adjust the horizontal drive control, if necessary.

There should be 10-volt bias at the cathode of the horizontal-output tube. The 10- $\mu$ f cathode-bypass capacitor could possibly be shorted if you find little or no bias here.

Likewise, you should find 165 volts at the screen of the horizontal output tube. If this voltage is high, you should check the .047- $\mu$ f bypass capacitor for leakage. END

**NEXT MONTH'S  
TV CLINIC  
Faulty Tubes  
in the  
Color Section**

By ROBERT B. COOPER, JR.

TIPS

## from a TV DX-ers notebook

*Types of dx reception and  
necessary receiving equipment  
and techniques*

THE field and hobby of television dx-ing have grown to such proportions during the past 4 years that the number of dx-ers currently twirling the dials is estimated in the thousands. For most of them the only contact with other weak-signal chasers is through the TV dx column appearing in RADIO-ELECTRONICS on a regular basis (alternate months).

Along with predictions of dx conditions and news of unusual loggings, we often receive requests for information pertaining to antennas, when to look for dx, receivers, accurate record keeping and many other phases of full-scale dx-ing. Here are a few tips for those who are interested in TV dx but may not know how to break into the field.

Receiving dx stations (those not normally seen at your location) is not nearly so much a function of the location of the observer and the equipment used as it is of being at the right place at the right time. In dx-ing circles many make use of a "timetable" (see table) to give basic information concerning the types of dx we might expect during various periods of the year. During a year's time seasonal weather changes and the position of the Earth in relation to the Sun and other heavenly bodies have pronounced effects on dx conditions.

**Types of dx reception**

The most common form of dx is that denoted by the term "sporadic-E skip." Sporadic-E skip (abbreviated Es) affects the lower television channels (2-6), bringing reception to your location from stations on an average of 500-1,500 miles distant. Various forms of Es have been known to provide reception for distances as great as 6,600 miles, although this is exceedingly rare. Es is a result of the television signal being reflected from a densely ionized layer, called the E layer, of the ionosphere. This layer exists at a height of 60-70 miles above the Earth. Under normal conditions the layer's density is very low and very-high-frequency television signals pass through the layer and on into space, never to return. It is only during periods of freak ionization conditions that the layer forms (actually forming in spots and not as a whole layer) and causes low-channel television signals to rebound from it as if it were a mirror.

Occurring on all TV channels, but most pronounced on high-band (channels 7-13) vhf and on uhf, is tropospheric (abbreviated tropo) bending or

conveyance of television waves to areas beyond the radio horizon via the troposphere. The tropospheric layer exists immediately adjacent to the Earth, and the majority of our weather occurs in it. Tropo is actually caused by sharp boundaries formed in weather fronts which act as a duct, carrying the signal to distant points. This form of reception occurs, for the most part, during the spring, early summer and early fall months of the year. Distances covered vary from 200-800 miles.

A form of dx-ing theoretically possible, during the next few years at least, is F2 skip. Like the E layer, the F2 layer of the ionosphere is often capable of reflecting television signals back to Earth during years of peak sunspot activity. The channels influenced most often by this form of skip are the lowest (2-4). The distances covered by F2 are enough to stagger even the most imaginative mind, beginning at 2,200 miles and working upward in steps of 2,000 miles at a time. This form of dx-ing promises to be extra interesting as it will provide us with the opportunity to view programs originating in other countries and even other continents!

Lastly, we have what is commonly known as the dx-ers' form of dx. As sensitive receiver design developed to usable levels and antennas with higher gain were put on the market, alert observers began to notice a form of burst reception. Short bursts of reception could be obtained for seconds at a time during periods when no signs of dx were present. It was decided that these bursts were a result of meteorites entering the E layer of the ionosphere and burning up there. As the friction causes them to burn, they leave a trail of ionized gas. Thus, like regular Es, meteor bursts (or MS) could provide reception from stations 500-1,500 miles distant. As meteorites are entering the E layer at all times (though in varying degrees of intensity), we are able to log distant stations whenever we wish. The only hitch in the scheme is the short duration of the bursts. It usually takes many bursts to identify



TV dx picked up in Fresno, California. Top, WBAP-TV, channel 5, Fort Worth, Texas, June, 1956. Center, KFEL-TV, channel 2, Denver, Colorado, July, 1955. Bottom, CHCT, channel 2, Calgary, Alberta, Canada, June, 1955.

the program material and a few more to identify the source. Lots of patience and a good deal of practical experience really pay off with this form of dx-ing.

Keeping an accurate log is a very important part of dx-ing. As dx-ers, we are able to provide scientists with a great deal of information not obtainable in any other way. TV dx is definitely freakish in nature and is therefore subject to explanation. However, as with many other occurrences in nature, information is needed before detailed study may begin. RADIO-ELECTRONICS is providing without cost through the TV dx column specially prepared forms on which you may report your dx observations. When your reports are combined with those from other sections of the country, scientists get a broad view of dx conditions over the country as a whole for any given date. An accurate log is also important when you wish to write to stations requesting letters of verification for your reception. It is always best to include information as taken from the receiver screen or audio, referring to local advertisements, etc. This will help the station in verifying your report. Many dx-ers have verification letters from 100 or more stations.

### Receiving equipment

During the past 2 to 3 years the old-timers in the dx game have become increasingly aware of the fact that the newer television receivers are sadly lacking in many dx essentials. In fact, with the current drive to use multi-purpose tubes, etc. for receiver compactness individual set gain and stability have deteriorated measurably. Therefore, dx-ers usually recommend that newcomers in the game purchase a sensitive receiver having a cascode front end (cascode rf stage). Keeping your receiver in good electrical working order is very important. If you do a moderate amount of dx-ing, change the rf amplifier tube every few months. Other important tubes such as the detectors, if amplifiers, rectifiers, etc. should all be tested frequently and perhaps changed completely every year. Remember, the only difference between the receiver you use for dx-ing and the one your neighbor uses for normal home viewing is the shape you keep yours in.

Boosters are also frequently mentioned. Remember this simple rule: If your receiver is of late-model design, with a cascode type rf amplifier stage, boosters are of very little value. Receivers using pentode and triode rf amplifier stages will benefit greatly from a cascode booster stage.

When we approach the question of the correct antenna for dx-ing purposes (or just plain deep-fringe reception), we encounter a controversy. Some dx-ers prefer large-screen reflector arrays with dipoles situated in front for signal pickup. Others lean toward the various forms of Yagi antennas while still others like the collinear style. To

DX TIME TABLE			
Period of year	Types of dx	Optimum Hours (Times 24-hour LST)	Data
Nov. 15-Feb. 15	Sporadic Es	0700-0900 1600-2100	Peak of minor Es season.
Feb. 1-May 1 Oct. 1-Dec. 1	F2 Skip	0700-1300 1100-1300	Stations to east in am; to south in late am, early pm; west in early p.m.
Aug. 9-15 Dec. 10-15 April 15-21	Meteor scatter dx peaks	0500-0900 1100-1400 1900-0100	Peak periods of meteorite showers, although MS is always active.
March 1-April 15	Trops dx (ground wave)	0500-0900 1900-0200	Usually produces excellent trops along the Gulf coast.
May 15-July 30	Trops dx	0600-1100 2000-0200	Excellent trops on occasion in Midwest and along Great Lakes.
Aug. 20-Oct. 10	Trops dx	no set time	Annual trops dx peak over entire country. Usually peaks in mid-September.
April 15-Aug. 15	Sporadic Es	0600-1000 1200-1400 1700-2200	Es hits phenomenal uprise in number of openings, with Es on 50% of the days from any given location.

provide optimum gain on each channel with a single antenna is an engineering feat yet to be accomplished. However, several compromises may be made to give fair to good gain across the spectrum and still allow the use of a single antenna for all-channel vhf operation. What is wanted is as much gain as it is possible to get, high front-to-back ratio and good directivity. Many dx-ers use 5- or 10-element Yagi's for channel 2 and then some form of all-channel for the rest. The reason for this is that both Es and F2 work up from the lowest channels. Thus, a good antenna system on channel 2 is a big help. If you have a local on channel 2, a similar system for channel 3 would also serve the purpose. Stacking Yagi antenna arrays pays off for weak-signal reception.

Antenna transmission line is also important. Keep the line in as good physical condition as possible. Of course, the best line is that with the lowest signal loss: 300-ohm open-wire line does an admirable job and 450-ohm open-wire line is also very good. A problem here is matching the 450-ohm lead-in with a 300-ohm receiver input and 300-ohm antenna. If open wire can be used, we suggest the 300-ohm version. If you have problems with your open-wire line continually shorting to the mast or tower as you rotate the antenna, try using the 300-ohm tubular uhf line. The loss is very low and the plastic insulation keeps out moisture, dust, etc. Try to use just one piece of line from the receiver to the antenna as splices create more signal loss.

Getting your antenna high above ground and the surrounding objects is also of prime importance. If you live in an area with many power lines, poles, high trees, etc., raising your antenna above them will really help reception. Giving the antenna a clear shot at the

dx stations is the whole idea in back of raising it into the heights. Power lines, rooftops, trees and the like all add to the amount of signal absorbed or reflected before it reaches your antenna. As you raise it up in the air, your antenna begins to break into signal levels that have not been decreased by absorption. A height of 70 feet above ground is a good minimum height for serious dx-ers, although good results can be had down to around 40 feet. A good rule might be: Raise the antenna as high as guy wire, guying space, pipe, neighborhood policy and your pocketbook allow.

Rotating the antenna can and does make all the difference in the world. Remember, you are using a high-gain antenna with its power punch concentrated in the forward direction. It

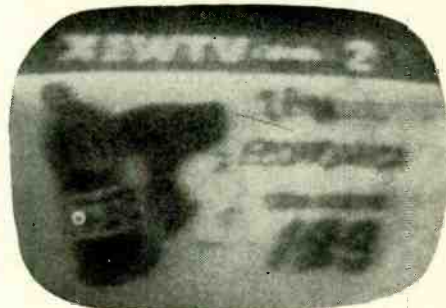

Courtesy Richard Lowry, Temple, Tex.

XEW TV, channel 2, Mexico City, Mexico, seen in Temple, Tex., March, 1955.

is designed to reject signals from the rear and sides. Any one of the popular antenna rotators is recommended for dx reception from all directions.

When using a large Yagi antenna array be sure that it is at least four boomlengths above any surrounding objects like trees and rooftops. This will assure you of a proper radiation pattern. If you cannot erect a Yagi array so that it is several boomlengths

## TELEVISION

from any objects at the same height, it would be better to try some other form of antenna.

### Dx tips

**Venetian blinds:** Horizontal bars move across the screen, alternating black and white. This is a sign of two (or more) stations on the same channel, the bars being what is commonly termed a beat note. The blind effect on a channel normally clear of them is the tipoff that some sort of dx is trying to appear. Careful orientation of the antenna will usually bring it in. If you are not able to bring the dx station through a local or sublocal station, find the antenna heading in which the interference is strongest and then check the rest of the channels for signs of other dx stations.

**Frequent signal bursts on a clear channel:** This is a sign of either a meteorite shower or the formation of a Es cloud. In either case you should stick around for the next few hours and make frequent channel checks.

**Fringe-area stations lose their snow:** This is a sure sign that good trop conditions are forming. First, determine in which direction the conditions are improving and then check the channels for weak stations not normally seen. (As fringe-area stations become of "local quality," dx stations appear with "fringe-area quality.")

If you live very near transmitters, there is not much that can be done for reception of dx stations on the same channels as the locals. For reception on adjacent channels, special traps can be used to filter out the overload from your locals, thus leaving the adjacent channels for dx reception. These adjacent-channel traps can do a lot for reception of Es signals. If you live 20 miles or so from the actual transmitter site, you should be able to bring strong E-skip stations in with the help of a folded-dipole antenna to attenuate the local station. The dipole antenna consists of a length of 300-ohm line cut to a half-wavelength on the interfering channel. Fed with another length of lead-in in the usual manner, you have a very effective antenna for cutting out locals by cancellation. Mount the dipole on a piece of board and experiment with it at various heights to find the highest you can go before getting into the extra-strong local signals. By carefully orienting the dipole, you will be able to "phase" out the local and allow the dx skip station to come through.

From several experiments made in California, we have found the best height above ground for the dipole is around 20 feet. For this antenna, height above ground is the all-important factor. If you wish to use a single dipole for the five low channels, find a compromise length in the vicinity of channel 4.

For the latest in dx information and predictions of things to come, watch RADIO-ELECTRONICS' TV dx column. END

# A TALE FROM CUBA

By L. F. FENTON

ONE of our service technicians brought a TV set to the shop. He reported "It shows white streaks on the screen, as if the antenna connection were loose." I checked: as a matter of fact, it was loose.

The set works nicely, but after a while a flash appears on the screen, and then more of them. It seems there is some other fault besides the loose antenna. With a station tuned in, white horizontal streaks appear. Without a station, or with the antenna disconnected, there are no streaks, but bursts of dark dots. It seems there is some arcing in the set and its radiation enters through the front end. By removing the mixer tube—or any tube of the if or video strip—the dots disappear.

All that is left to do is to localize the arcing and remove it. Most probably some part of the high-voltage equipment is guilty. These parts are well secured in the high-voltage cage. Removing the cover, only the two high-voltage rectifier tubes and two 1.5-megohm resistors are visible. They are mounted on a piece of bakelite. The flyback transformer and the high-voltage filter capacitors are mounted on the rear of this form, and remain entirely hidden in the high-voltage cage. So I decided to go the easy way: check first the parts outside the cage. The arcing most likely occurs at the connection of the high-voltage lead to the metal picture tube; so I tighten it carefully. No result. Perhaps the horizontal output tube: I change it; I change the horizontal oscillator, the damper and the high-voltage rectifiers too. No result. The 1.5-megohm resistors check OK with an ohmmeter; but to be on the safe side, I exchange them. No result. I put a new picture tube in the set. I try to tap gently (well, more or less gently) all tubes and other parts. I cannot provoke the streaks by tapping, moving, pushing or pulling any part of the set. On the contrary, the streaks seem to occur independently of any

human influence. Very intriguing!

So then I disconnect a number of leads, remove the picture tube, the yoke and the cage to get at the flyback. Should this be the bad part, it would be a minor tragedy. It is of special construction, a standard flyback does not fit easily. Checking with an ohmmeter shows that the high-voltage winding is open; evidently it arcs inside the coil. So I have found it at last.

I install a new flyback. Yes, it behaves itself. I watch it several minutes. But what is this? Again a streak; then several more. These streaks do not appear as often as before, but they are most annoying. Is it possible that the brand-new flyback is defective? Out comes the high-voltage supply. The flyback checks OK with the ohmmeter. And I can see absolutely no trace of corona—only the streaks on the screen which are really annoying (or am I repeating myself?).

I decide to make another experiment. To localize the arcing I connect the video output of the sick set into the C-R tube of a second set. This arrangement works fine—picture and streaks appear on this tube too. Then I disable the high-voltage supply of the first set, removing the horizontal output tube—the streaks remain. I remove the horizontal and vertical oscillators and the sound section, with the same result. So it is definitely established, the fault is not in the high-voltage supply, neither in the vertical or sound section. In fact, the only remaining part in the front end, if and video strip and the low-voltage supply.

First I replace the front end. And believe it or not, for the first time there is a result, the streaks disappear. Well, to make a long story short, besides the flyback, a coil in the front end was guilty. It was open (ohmmeter reading more than 1,000 megohms), but it passed the whole plate voltage to the mixer tube. Evidently it arced. Replacing it with a new one, the set worked smoothly. END



# Practical COLOR

## Installation

Part III—Wherein Red gives Fuzzball the pitch on horizontal dynamic convergence

By BOB MIDDLETON

THEY ought to make the cook drink this coffee," Fuzzball grumbled.

"That would be unconstitutional," Red observed; "cruel and unusual punishment. Besides, he's big enough and mean enough to make *you* drink it."

"Not to change the subject," replied Fuzzball, "but what's the pitch on horizontal dynamic convergence? You got me clued in pretty good on the vertical."

"Well, now," Red said slowly, "you'll find that horizontal isn't too much different from vertical. Unless, of course, you start getting some of them queer notions of yours."

"I'll pretend I didn't hear that last remark," replied Fuzzball evenly. "Should I keep the center of screen in convergence with the beam magnets while I'm working with the horizontal dynamic?"

Red turned to the tired-looking waitress. "Give the man a five-cent cigar, Bessie. He's hot as a pistol today."

Bess started to open the corner of her mouth and then shut it again.

"It figures," explained Fuzzball, "because that's what works out best when you're working with the vertical dynamic controls."

"Tell me more," Red said encouragingly.

"You tell me," protested Fuzzball. "What do I do next?"

"Well, you should start by resonating the horizontal phasing coils."

"Come again, already?"

"First turn the blue amplitude control to maximum," Red explained patiently. "Then turn the core in the blue phasing coil to curve the dots or lines to a peak or dip in the center of the screen. Look, I got a photo here that I tore out of RADIO-ELECTRONICS." [See photo at head of article, also Fig. 1-a.—*Editor*]

"Why?" asked Fuzzball.

"Because I wanted to keep it to refer to," snapped Red.

"I mean, why do you want to resonate the phasing coil?" protested Fuzz.

"Simple, you simple boy," Red explained, "because then you will have the coil pretty near its final setting. Saves a lot of wasted time."

"And you do the same thing with the

(Continued on page 78)

The photo that Red—by coincidence—had torn out of Radio-Electronics.

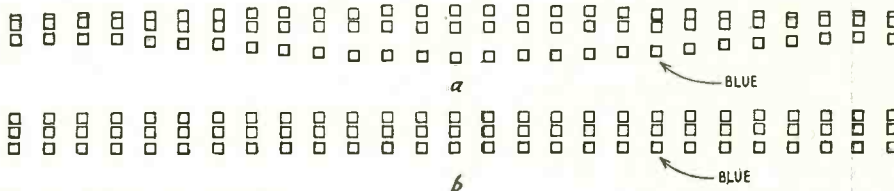
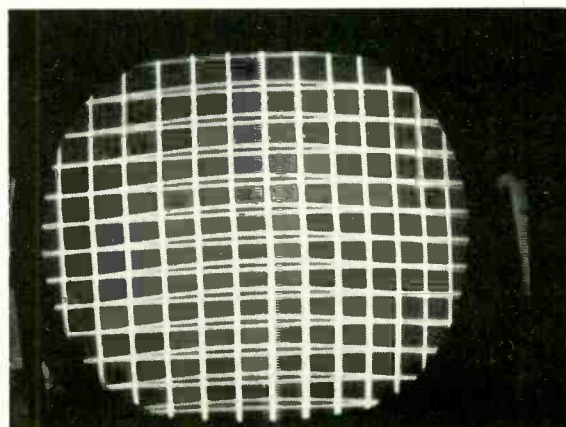

Fig. 1—"Turn the core in the blue phasing coil to curve the dots to a dip in the center (a) . . . then adjust the horizontal amplitude control to get a good straight line (b)."

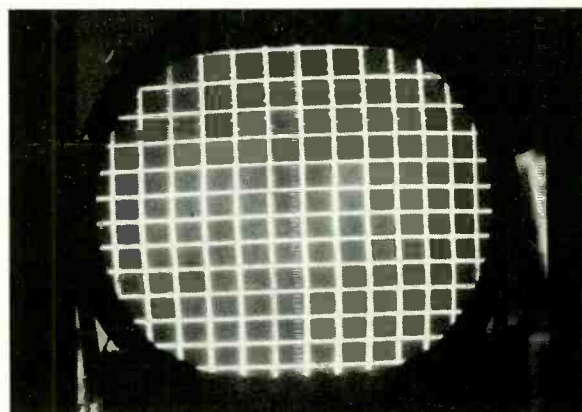

Fig. 2—" . . . another photo showing this desirable situation."

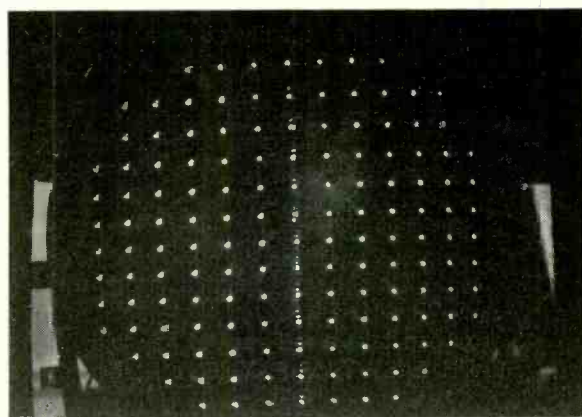
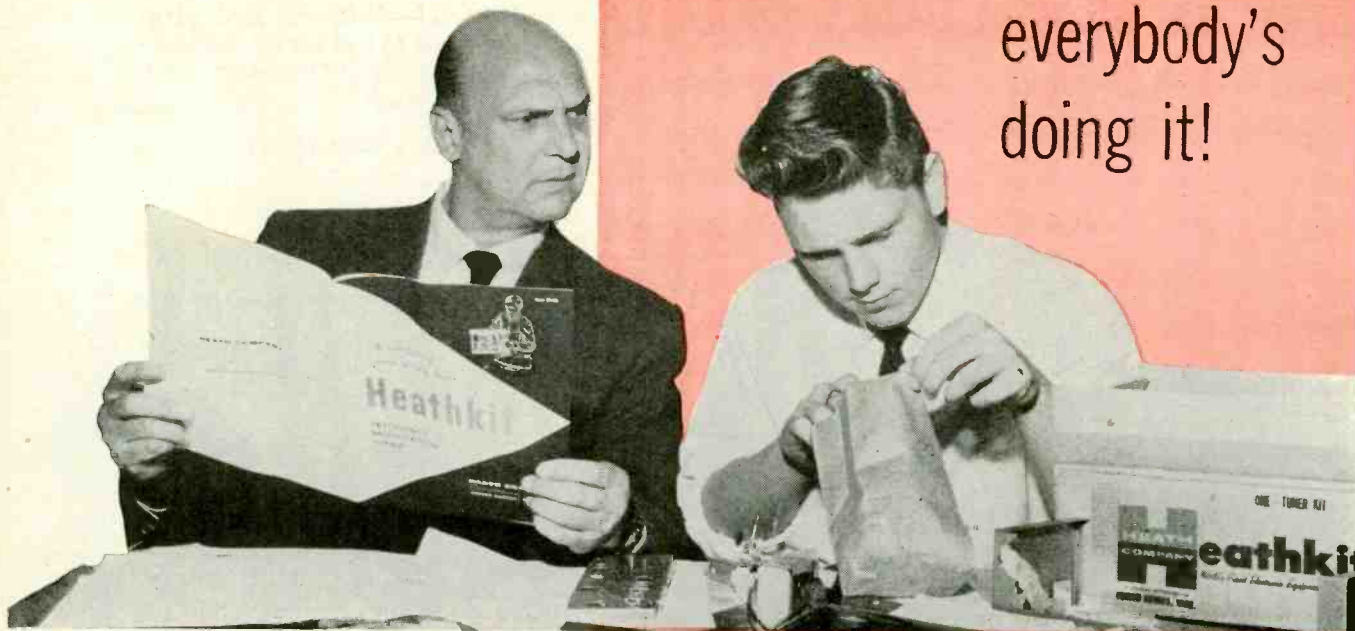
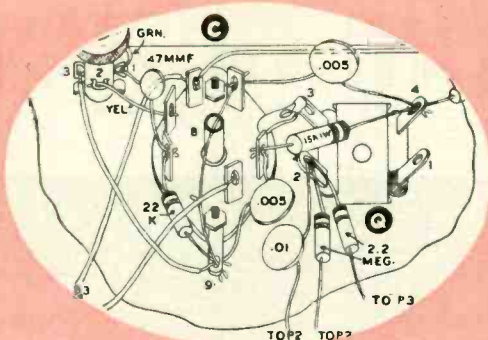

Fig. 3—"The crosshatch pattern doesn't show up miscoverage nearly as plain as the little dots."



everybody's  
doing it!

Motion picture and TV personality, Jackie Coogan, looks on with unbelieving interest as his 14-year-old son, Anthony, prepares to assemble his latest Heathkit, a hi-fi FM tuner. The Coogans have found out about the fun and savings of building their own electronic equipment the Heathkit way . . . so why don't you?



You'll get plenty of these detailed pictorial diagrams in your Heathkit construction manual to show where each and every wire and part is to be placed. Everything you do is spelled out in pictures so you can't go wrong. That's what makes it such fun!

# Heathkits<sup>®</sup>

By DAYSTROM

...fun to build  
and a thrill to own!

and here's why...

1. You get higher quality at lower cost by dealing direct, and by doing your own assembly.
2. You receive personal, friendly, service (before and after sale) for complete satisfaction.
3. You benefit from the latest in engineering designs because of our concentration on kit-form equipment only.
4. You may depend on performance as advertised—backed by Heath's world-wide reputation for quality.
5. You can take a full year to pay with the **HEATH EASY TIME PAYMENT PLAN.**

- (✓) Connect a 22 K $\Omega$  resistor (red-red-orange) from socket C1 (NS) to ground lug C9 (NS). See Figure 8.
- (✓) Connect a .005  $\mu$ d disc capacitor from socket C4 (NS) to 1F transformer Q4 (NS).
- ( ) Bend socket lug C5 and 1F transformer lug Q3 toward each other until they make contact and overlap slightly. Solder the connecting securely. (1).
- ( ) Install a .005  $\mu$ d capacitor from socket C4 (NS) to ground lug C9 (NS). Dress the capacitor close to chassis, under the capacitor previously installed.

Read the step . . . perform the operation . . . and check it off—it's just that simple. These plainly-worded, easy-to-follow, steps are combined with pictorial diagrams to take you through every phase of assembly. Let our experience be your teacher!

### TIME PAYMENTS . . .

The Heath Time Payment Plan was designed for your convenience. Now, you can order the kits of your choice, and pay for them in small monthly installments. Write for full details.

### HEATHKIT EXTRA PERFORMANCE 70-WATT AMPLIFIER KIT

For really high performance, with plenty of reserve power, the W-6M is a natural. The full 70-watts output will seldom, if ever, be required. However, this reserve insures distortion-less sound on power peaks. The W-6M will loaf along at normal listening levels and yet is always ready to extend itself when program material demands it, without the least amount of strain. The output circuit employs 6550 tubes with a special-design Peerless output transformer for maximum stability at all power levels. A quick-change plug selects 4, 8 and 16 ohms or 70-volt output and the correct feedback resistance. A variable damping control is also provided for optimum performance with any speaker system. Extremely good power supply regulation is possible through the use of a heavy-duty transformer along with silicon-diode rectifiers, which are noted for their very long life, and yet are smaller than a house fuse. Frequency response at 1 watt is  $\pm 1$  db from 5 cps to 80 kc with controlled hf rolloff above 100 kc. At 70 watts output harmonic distortion is below 2%, 20 to 20,000 cps and IM distortion below 1%, 60 and 6,000 cps. Hum and noise 88 db below full output. In addition to high performance, its fine appearance makes it a pleasure to display in your living room. Proper layout of chassis insures ease of assembly by eliminating those cramped and difficult places to get at. Clear instructions—and top-quality components. Get started now and make this amplifier the heart of your hi-fi system. Shipped express only. Shpg. Wt. 50 lbs.

MODEL W-6M

**\$109<sup>95</sup>**

MODEL W-6: Consists of W-6M kit, plus WA-P2 preamplifier. Express only. Shpg. Wt. 59 lbs. \$129.70

### HEATHKIT HIGH FIDELITY FM TUNER KIT

This tuner can bring you a rich store of FM programming, your least expensive source of high fidelity material. It covers the complete FM band from 88 to 108 mc. Stabilized, temperature-compensated oscillator assures negligible drift after initial warmup. Features broadbanded circuits for full fidelity, and better than 10 uv sensitivity for 20 db of quieting, to pull in stations with clarity and full volume. Employs a high gain, cascode RF amplifier, and has AGC. A ratio detector provides high-efficiency demodulation without sacrificing hi-fi performance. IF and ratio transformers are prealigned, as is the front end tuning unit. Special alignment equipment is not necessary. Edge-lighted glass dial for easy tuning. Here is FM for your home at a price you can afford. Shpg. Wt. 8 lbs.

MODEL FM-3A

**\$25<sup>95</sup>**

(with cabinet)

### HEATHKIT BROADBAND AM TUNER KIT

This AM tuner was designed especially for high fidelity applications. It incorporates a special detector using crystal diodes, and the IF circuits feature broad band-width, to insure low signal distortion. Audio response is  $\pm 1$  db from 20 cps to 9 kc, with 5 db of preemphasis at 10 kc to compensate for station rolloff. Sensitivity and selectivity are excellent, and tuner covers complete broadcast band from

550 to 1600 kc. Quiet performance is assured by 6 db signal-to-noise ratio at 2.5 UV. Prealigned RF and IF coils eliminate the need for special alignment equipment. Incorporates AVC, two outputs, two antenna inputs, and built-in power supply. Edge-lighted glass slide-rule dial for easy tuning. Your "best buy" in an AM tuner. Shpg. Wt. 8 lbs.

MODEL 8C-1A

**\$25<sup>95</sup>**

(with cabinet)

### HEATHKIT MASTER CONTROL PREAMPLIFIER KIT

Designed for use with any of the Williamson-type amplifiers, the WA-P2 has five switch-selected inputs, each having its own level control to eliminate blasting or fading while switching through the various inputs, plus a tape recorder output. A hum control allows setting for minimum hum level. Frequency response is within  $\pm 1\frac{1}{2}$  db from 15 to 35,000 cps. Equalization provided for LP, RIAA, AES, and early 78's. Separate bass and treble controls. Low impedance cathode follower output circuit. All components were specially selected for their high quality. Includes many features which will eventually be desired. Shpg. Wt. 7 lbs.

MODEL WA-P2

**\$19<sup>75</sup>**

(with cabinet)

*An amplifier you will be proud to own*

70-WATT AMPLIFIER

FM-TUNER

AM-TUNER

*Selects and controls sound to your taste*

PREAMPLIFIER



**ADVANCED-DESIGN  
25-WATT AMPLIFIER**

*Top performance  
in its  
power class!*

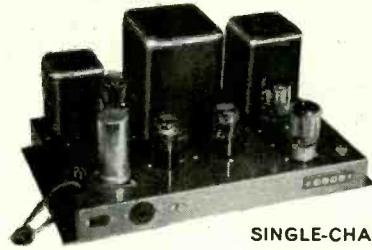

**SINGLE-CHASSIS  
20-WATT AMPLIFIER**

*Hi-Fi equipment  
for your listening  
pleasure!*

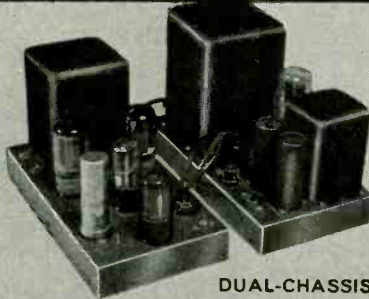

**DUAL-CHASSIS  
20-WATT AMPLIFIER**



**GENERAL-PURPOSE  
20-WATT AMPLIFIER**

**HEATHKIT ADVANCED-DESIGN 25-WATT HIGH FIDELITY AMPLIFIER KIT**

Designed especially to satisfy critical audio requirements, the W-5M incorporates the extra features needed to complement the finest in program sources and speaker systems. Faithful sound reproduction is assured with a frequency response of  $\pm 1$  db from 5 to 160,000 cps at 1 watt, and harmonic distortion is less than 1% at 25 watts, with IM distortion less than 1% at 20 watts. Hum and noise are a full 99 db below rated output, assuring quiet, hum-free operation. Output taps are 4, 8 and 16 ohms. Exclusive Heathkit features include the "tweeter saver", and the "bas-bal" balancing circuit, requiring only a voltmeter for indication. Years of reliable service are guaranteed through the use of conservatively rated, high quality components. KT66 tubes and Peerless output transformer are typical. Shipped express only. Shpg. Wt. 31 lbs.

**MODEL W-5:** Consists of W-5M kit above plus model WA-P2 preamplifier. Express only. Shpg. Wt. 38 lbs. \$79.50

**MODEL W-5M**  
**\$59<sup>75</sup>**

**HEATHKIT SINGLE-CHASSIS 20-WATT HIGH FIDELITY AMPLIFIER KIT**

The model W4-AM Williamson-type amplifier will amaze you with its outstanding performance. A true Williamson circuit, featuring extended frequency response, low distortion, and low hum levels, this amplifier can provide you with many hours of listening enjoyment with only a minimum investment compared to other units on the market. 5881 tubes and a special Chicago-standard output transformer are employed to give you full fidelity at minimum cost. Frequency response extending from 10 cps to 100 kc within  $\pm 1$  db at 1 watt assures you of full coverage of the audio range, and clean clear sound amplification takes place in circuits that hold harmonic distortion at 1.5% and IM distortion below 2.7% at full 20 watt output. Hum and noise are 95 db below full output. Taps on the output transformer are at 4, 8 or 16 ohms. Shipped express only. Shpg. Wt. 28 lbs.

**MODEL W-4A:** Consists of W-4AM kit above, plus model WA-P2 preamplifier. Express only. Shpg. Wt. 35 lbs. \$59.50.

**MODEL W4-AM**  
**\$39<sup>75</sup>**

**HEATHKIT DUAL-CHASSIS 20-WATT HIGH FIDELITY AMPLIFIER KIT**

The model W3-AM is a Williamson-type amplifier built on two separate chassis. The power supply is on one chassis, and the amplifier stages are on the other chassis. Using two separate chassis provides additional flexibility in installation. Features include the famous acrosound model TO-300 "ultralinear" output transformer and 5881 tubes for broad frequency response, low distortion, and low hum level. The result is exceptionally fine overall tone quality. Frequency response is  $\pm 1$  db from 6 cps to 150 kc at 1 watt. Harmonic distortion is less than 1% and IM distortion is less than 1.3% at 20 watts. Hum and noise are 88 db below 20 watts. Designed to match the speaker system of your choice, with taps for 4, 8 or 16 ohms impedance. A very popular high fidelity unit employing top quality components throughout. Shipped express only. Shpg. Wt. 29 lbs.

**MODEL W-3A:** Consists of W-3AM kit above plus model WA-P2 preamplifier. Express only. Shpg. Wt. 37 lbs. \$69.50

**MODEL W-3AM**  
**\$49<sup>75</sup>**

# Heathkits...

By DAYSTROM

*bring you the lasting satisfaction  
of personal accomplishment*

**HEATHKIT GENERAL-PURPOSE 20-WATT HIGH FIDELITY AMPLIFIER KIT**

The model A-9C will provide you with high quality sound at low cost. Features a built-in preamplifier with four separate inputs, and individual volume, bass and treble controls. Frequency response covers 20 to 20,000 cps within  $\pm 1$  db. Total harmonic distortion is less than 1% at 3 db below rated output. Push-pull 6L6 tubes are used, with output transformer tapped at 4, 8, 16 and 500 ohms. A true hi-fi unit using high-quality components throughout, including heavy-duty "potted" transformers.

Shpg. Wt. 23 lbs.

**MODEL A-9C**  
**\$35<sup>50</sup>**



**HEATHKIT "BASIC RANGE"  
HI-FI SPEAKER SYSTEM KIT**

The extremely popular Heathkit model SS-1 Speaker System provides amazing high fidelity performance for its size. Features two high-quality Jensen speakers, an 8" mid-range woofer and compression-type tweeter with flared horn. Covers from 50 to 12,000 CPS within  $\pm 5$  db, in a special-design ducted-port, bass reflex enclosure. Impedance is 16 ohms. Cabinet measures 11 $\frac{1}{2}$ " H x 23" W x 11 $\frac{1}{4}$ " D. Constructed of veneer-surfaced plywood,  $\frac{1}{2}$ " thick, suitable for light or dark finish. All wood parts are precut and predrilled for easy, quick assembly. Shpg. Wt. 30 lbs.

MODEL SS-1

**\$39<sup>95</sup>**

**HEATHKIT "RANGE EXTENDING"  
HI-FI SPEAKER SYSTEM KIT**

Extends the range of the SS-1 to  $\pm 5$  db from 35 to 16,000 CPS. Uses 15" woofer and super-tweeter both by Jensen. Kit includes crossover circuit. Impedance is 16 ohms and power rating is 35 watts. Measures 29" H x 23" W x 17 $\frac{1}{2}$ " D. Constructed of veneer-surfaced plywood  $\frac{3}{4}$ " thick. Easy to build! Shpg. Wt. 80 lbs.

MODEL SS-1B

**\$99<sup>95</sup>**

**HEATHKIT "LEGATO"  
HIGH FIDELITY SPEAKER SYSTEM KIT**

The quality of the Legato, in terms of the engineering that went into the initial design, and in terms of the materials used in its construction, is matched in only the most expensive speaker systems available today. The listening experience it provides approaches the ultimate in esthetic satisfaction. Two 15" theater-type Altec Lansing speakers cover 25 to 500 CPS, and an Altec Lansing high-frequency driver with sectoral horn covers 500 to 20,000 CPS. A precise amount of phase shift in the crossover network brings the high frequency channel into phase with the low frequency channel to eliminate peaks or valleys at the crossover point, by equalizing the acoustical centers of the speakers. The enclosure is a modified infinite baffle type, especially designed for these speakers. Cabinet is constructed of veneer-surfaced plywood,  $\frac{3}{4}$ " thick, precut and predrilled for easy assembly. Frequency response 25 to 20,000 CPS. Power rating, 50 watts program material. Impedance is 16 ohms. Cabinet dimensions 41" L x 22 $\frac{1}{4}$ " D x 34" H.

Choice of two beautiful cabinets. Model HH-1-C in imported white birch for light finishes, and HH-1-CM in African mahogany for dark finishes. Shpg. Wt. 195 lbs.

MODEL HH-1-C  
MODEL HH-1-CM

**\$325<sup>00</sup>**

EACH

# Heathkits...

By DAYSTROM

*let you save up to 1/2  
or more on all types  
of electronic equipment.*

**HEATHKIT SINE-SQUARE GENERATOR**

The new AG-10 provides high quality, sine and square waves over a wide range, for countless applications. Some of these are; radio and TV repair work, checking scope performance, as a variable trigger source for telemetering and pulse work, and checking audio, video and hi-fi amplifier response. Frequency response is  $\pm 1.5$  db from 20 CPS to 1 MC on both sine and square waves, with less than .25% sine wave distortion, 20 to 20,000 CPS. Sine wave output impedance 600 ohms, square wave output impedance 50 ohms, (except on 10v ranges). Square wave rise time less than .15 usec. Five-position band switch—continuously variable tuning—shielded oscillator circuit—separate step and variable output attenuators in ranges of 10, 1, and .1 volts for both sine and square wave, with extra range of .01 volt on sine wave. Both sine and square wave can be used at the same time without affecting either wave form. Power supply uses silicon-diode rectifiers. Shpg. Wt. 12 lbs.

MODEL AG-10

**\$49<sup>95</sup>**

**HEATHKIT AUDIO ANALYZER KIT**

The AA-1 is actually three instruments in one compact package. It combines the functions of an AC VTVM, an audio wattmeter, and an intermodulation analyzer. Input and output terminals are combined, and high and low frequency oscillators are built in. VTVM ranges are 0-.01, .03, .1, .3, 1, 3, 10, 30, 100 and 300 volts (RMS). Wattmeter ranges are .15 mw, 1.5 mw, 15 mw, 150 mw, 1.5 w, 15 w and 150 w. IM scales are 1%, 3%, 10%, 30% and 100%. Provides internal load resistors of 4, 8, 16 or 600 ohms. A tremendous dollar value. Shpg. Wt. 13 lbs.

MODEL AA-1

**\$49<sup>95</sup>**

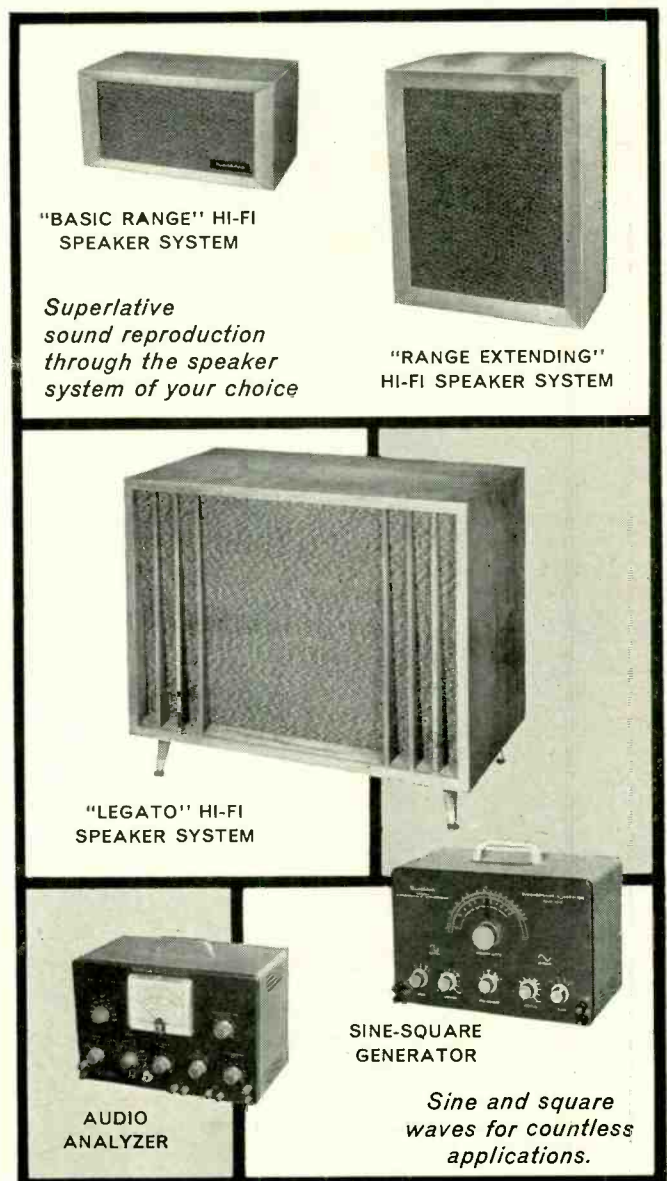

"BASIC RANGE" HI-FI  
SPEAKER SYSTEM

*Superlative  
sound reproduction  
through the speaker  
system of your choice*

"RANGE EXTENDING"  
HI-FI SPEAKER SYSTEM

"LEGATO" HI-FI  
SPEAKER SYSTEM

AUDIO  
ANALYZER

SINE-SQUARE  
GENERATOR

*Sine and square  
waves for countless  
applications.*

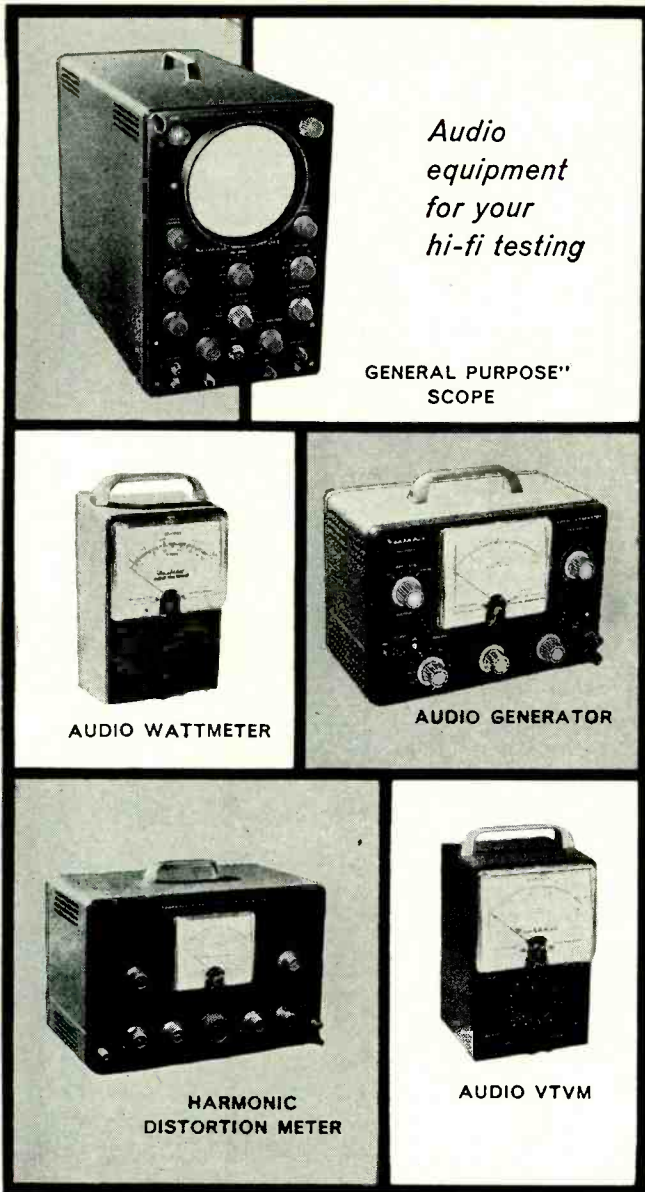

*Audio  
equipment  
for your  
hi-fi testing*

**GENERAL PURPOSE"  
SCOPE**

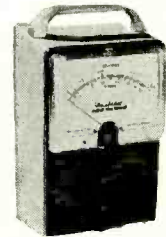

**AUDIO WATTMETER**



**AUDIO GENERATOR**



**HARMONIC  
DISTORTION METER**

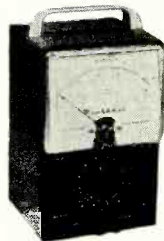

**AUDIO VTVM**

**HEATHKIT "GENERAL PURPOSE" 5"  
OSCILLOSCOPE KIT**

The model OM-2 Oscilloscope is especially popular with part-time service technicians, students, and high fidelity enthusiasts. It features good vertical frequency response  $\pm 3$  db from 4 cps to over 1.2 mc. A full five-inch crt. and sweep generator operation from 20 cps to over 150 kc. Stability is excellent and calibrated grid screen allows precise signal observation. Extra features include external or internal sweep and sync, 1-volt peak-to-peak calibrating reference, 3-position step-attenuated input, adjustable spot shape control, push-pull horizontal and vertical amplifiers, and modern etched-metal circuits. Easy to build and a pleasure to use. Ideal for use with other audio equipment for checking amplifiers. Shpg. Wt. 21 lbs.

MODEL OM-2  
**\$42<sup>50</sup>**

**HEATHKIT AUDIO WATTMETER KIT**

The AW-1 Audio Wattmeter can be used in any application where audio power output is to be measured. Non-inductive LOAD resistors are built in for 4, 8, 16 or 600 ohms impedance. Five power ranges cover 0.5 mw, 50 mw, 500 mw, 5 w, and 50 w full scale. Five switch-selected db ranges cover -10 db to +30 db. All indications are read directly on a large 4 1/2" 200 microampere meter. Frequency response is

$\pm 1$  db from 10 cps to 250 kc. Precision type multiplier resistors used for high accuracy, and crystal diode bridge for wide-range frequency response. This meter is used in many recording studios and broadcast stations as a monitor as well as servicing. A fine meter to help supply the answers to your audio operating or power output problems. Shpg. Wt. 6 lbs.

MODEL AW-1  
**\$29<sup>50</sup>**

**HEATHKIT AUDIO SIGNAL GENERATOR KIT**

The model AG-9A is "made to order" for high fidelity applications, and provides quick and accurate selection of low-distortion signals throughout the audio range. Three rotary switches select two significant figures and a multiplier to determine audio frequency. Incorporates step-type and a continuously variable output attenuator. Output indicated on large 4 1/2" panel meter, calibrated in volts and db. Attenuator system operates in 10 db steps, corresponding to meter calibration, in ranges of 0-.003, .01, .03, .1, .3, 1, 3 and 10 volts RMS. "Load" switch permits use of built-in 600-ohm load, or external load of different impedance. Output and frequency indicators accurate to within  $\pm 5\%$ . Distortion less than .1 of 1% between 20 and 20,000 cps. Total range is 10 cps to 100 kc. Shpg. Wt. 8 lbs.

MODEL AG-9A  
**\$34<sup>50</sup>**

**HEATHKIT HARMONIC DISTORTION METER KIT**

All sounds consist of dominant tones plus harmonics (over-tones). These harmonics enrich the quality and brightness of the music. However, additional harmonics which originate in the audio equipment, represent distortion. Used with an audio signal generator, the HD-1 will accurately measure this harmonic distortion at any or all frequencies between 20 and 20,000 cps. Distortion is read directly on the panel meter in ranges of 0-1, 3, 10, 30 and 100% full scale. Voltage ranges of 0-1, 3, 10 and 30 volts are provided for the initial reference settings. Signal-to-noise ratio measurements are also permitted through the use of a separate meter scale calibrated in db. High quality components insure years of outstanding performance. Full instructions are provided. Shpg. Wt. 13 lbs.

MODEL HD-1  
**\$49<sup>50</sup>**

# Heathkits...

By DAYSTROM

*are well known for  
their high quality  
and reliability.*

**HEATHKIT AUDIO VTVM KIT**

This new and improved AC Vacuum Tube Voltmeter is designed especially for audio measurements and low-level AC measurements in power supply filters, etc. Employs an entirely new circuit featuring a cascode amplifier with cathode-follower isolation between the input and the amplifier, and between the output stage and the preceding stages. It emphasizes stability, broad frequency response, and sensitivity. Frequency response is essentially flat from 10 cps to 200 kc. Input impedance is 1 megohm at 1000 cps. AC (RMS) voltage ranges are 0-.01, .03, .1, .3, 1, 3, 10, 30, 100 and 300 volts. Db ranges cover -52 db to +52 db. Features large 4 1/2" 200 microampere meter, with increased damping in meter circuit for stability in low frequency tests. 1% precision resistors employed for maximum accuracy. Stable, reliable performance in all applications. Shpg. Wt. 5 lbs.

MODEL AV-3  
**\$29<sup>95</sup>**

### HEATHKIT COLOR BAR AND DOT GENERATOR

The CD-1 combines the two basic color service instruments, a Color Bar Generator and White Dot Generator in one versatile portable unit, which has crystal-controlled accuracy and stability (no external sync lead required). Produces white-dots, cross hatch, horizontal and vertical bars, 10 vertical color bars, and a new shading bar pattern for screen and background adjustments. Variable RF output on any channel from 2 to 6. Positive or negative video output, variable from 0 to 10 volts peak-to-peak. Crystal controlled sound carrier with off-on switch. Voltage regulated power supply using long-life silicon rectifiers. Gain knowledge of a new and profitable field by constructing this kit. Shpg. Wt. 12 lbs.

MODEL CD-1  
\$59<sup>95</sup>

# Heathkits...

By DAYSTROM

*are guaranteed to meet or exceed advertised specifications*

### HEATHKIT TV ALIGNMENT GENERATOR KIT

This fine TV alignment generator offers stability and flexibility difficult to obtain even in instruments costing several times this low Heathkit price. It covers 3.6 mc to 220 mc in four bands. Sweep deviation is controllable from 0 to 42 mc. The all-electronic sweep circuit insures stability. Crystal marker and variable marker oscillators are built in. Crystal (included with kit) provides output at 4.5 mc and multiples thereof. Variable marker provides output from 19 to 60 mc on fundamentals and from 57 to 180 mc on harmonics. Effective two-way blanking to eliminate return trace. Phasing control. Kit is complete, including three output cables. Shpg. Wt. 16 lbs.

MODEL TS-4A  
\$49<sup>50</sup>

### HEATHKIT "EXTRA DUTY" 5" OSCILLOSCOPE KIT

This fine oscilloscope compares favorably to other scopes costing twice its price. It contains the extra performance so necessary for monochrome and color-TV servicing. Features push-pull horizontal and vertical output amplifiers, a 5UPI CRT, built in peak-to-peak calibration source, a fully compensated 3-position step-type input attenuator, retrace blanking, phasing control, and provision for Z-axis modulation. Vertical amplifier frequency response is within +1.5 and -5 db from 3 CPS to 5 MC. Response at 3.58 MC down only 2.2 db. Sensitivity is 0.025 volts RMS/inch at 1 kc. Sweep generator covers 20 CPS to 500 kc in five steps, five times the usual sweep obtained in other scopes through the use of the patented Heath sweep circuit. Etched-metal circuit boards reduce assembly time and minimize errors in assembly, and more importantly, permit a level of circuit stability never before achieved in an oscilloscope of this type. Shpg. Wt. 21 lbs.

MODEL O-11  
\$69<sup>50</sup>

### HEATHKIT ELECTRONIC SWITCH KIT

A valuable accessory for any oscilloscope owner. It allows simultaneous oscilloscope observation of two signals by producing both signals, alternately, at its output. Four switching rates. Provides gain for input signals. Frequency response  $\pm 1$  db, 0 to 100 kc. A sync output is provided to control and stabilize scope sweep. Ideal for observing input and output of amplifiers simultaneously. Shpg. Wt. 8 lbs.

MODEL S-3  
\$21<sup>95</sup>

### HEATHKIT VOLTAGE CALIBRATOR KIT

This unit is an excellent companion for your oscilloscope. Used as a source of calibrating voltage, it produces near-perfect square wave signals of known amplitude. Precision 1% attenuator resistors insure accurate output amplitude, and multivibrator circuit guarantees good sharp square waves. Output frequency is approximately 1000 CPS. Fixed outputs selected by panel switches are; .03, 0.1, 0.3, 1.0, 3.0, 10, 30 and 100 volts peak-to-peak. Allows measurement of unknown signal amplitude by comparing it to the known output of the VC-3 on oscilloscope. Shpg. Wt. 4 lbs.

MODEL VC-3  
\$12<sup>50</sup>

*Functional styling with clean uncluttered look*



COLOR BAR AND DOT GENERATOR



"EXTRA DUTY" SCOPE



TV ALIGNMENT GENERATOR



ELECTRONIC SWITCH



VOLTAGE CALIBRATOR

### HEATHKIT TUBE CHECKER KIT

Eliminate guesswork, and save time in servicing or experimenting. The TC-2 tests tubes for shorted elements, open elements, filament continuity, and operating quality on the basis of total emission. It tests all tube types encountered in radio and TV service work. Sockets are provided for 4, 5, 6 and 7-pin, octal, and loctal tubes, 7 and 9 pin miniature tubes, 5 pin hytron miniatures, and pilot lamps. Tube condition indicated on 4½" meter with multi-color "good-bad" scale. Illuminated roll chart with all test data built in. Switch selection of 14 different filament voltages from .75 to 117 volts. Color-coded cable harness allows neat professional wiring and simplifies construction. Very easy to build, even for a beginner. Shpg. Wt. 12 lbs.

MODEL TC-2  
\$29.50

### HEATHKIT HANDITESTER KIT

The small size and rugged construction of this tester makes it perfect for any portable application. The combination function-range switch simplifies operations. Measures AC or DC voltage at 0-10, 30, 300, 1000 and 5000 volts. Direct current ranges are 0-10 ma and 0-100 ma. Ohmmeter ranges are 0-3000 (30 ohm center scale) and 0-300,000 (3000 ohm center scale). Very popular with home experimenters, electricians, and appliance repairmen. Slips easily into your tool box, glove compartment, coat pocket, or desk drawer. Shpg. Wt. 3 lbs.

MODEL M-1  
\$14.50

### HEATHKIT PICTURE TUBE CHECKER KIT

The CC-1 can be taken with you on service calls so that you can clearly demonstrate the quality of a customer's picture tube in his own home. Tubes can be tested without removing them from the receiver or cartons if desired. Checks cathode emission, beam current, shorted elements, and leakage between elements in electromagnetic picture tube types. Self-contained power supply, and large 4½" meter. CRT condition indicated on "good-bad" scale. Relative condition of tubes fluorescent coating is shown in "shadow-graph" test. Permanent test cable with CRT socket and anode connector. No tubes to burn out, designed to last a lifetime. Luggage-type portable case. Shpg. Wt. 10 lbs.

MODEL CC-1  
\$22.50

### HEATHKIT ETCHED-CIRCUIT VTVM KIT

This multi-purpose VTVM is the world's largest selling instrument of its type—and is especially popular in laboratories, service shops, home workshops and schools. It employs a large 4½" panel meter, precision 1% resistors, etched metal circuit board, and many other "extras" to insure top quality and top performance. It's easy to build, and you may rely on its accuracy and dependability. The V7-A will measure AC (RMS) and DC voltages in ranges of 0-1.5, 5, 15, 50, 150, 500 and 1500. It measures peak-to-peak AC voltage in ranges of 0-4, 14, 40, 140, 400, 1400 and 4000. Resistance ranges provide multiplying factors of X 1, X 10, X 100, X 1000, X 10k, X 100k, and X 1 megohm. Center-scale resistance readings are 10, 100, 1000, 10k, 100k, 1 megohm and 10 megohms. A db scale is also provided. The precision and quality of this VTVM cannot be duplicated at this price. Shpg. Wt. 7-lbs.

MODEL V7-A  
\$24.50

# Heathkits...

BY DAYSTROM

*let you fill your exact needs  
from a wide variety  
of instruments*

### HEATHKIT 20,000 OHMS/VOLT VOM KIT

This fine instrument provides a total of 25 meter ranges on its two-color scale. It employs a 50 ua 4½" meter, and features 1% precision multiplier resistors. Requires no external power. Ideal for portable applications. Sensitivity is 20,000 ohms-per-volt DC and 5000 ohms-per-volt AC. Measuring ranges are 0-1.5, 5, 50, 150, 500, 1500 and 5000 volts, AC and DC. Measures direct current in ranges of 0-150 ua, 15 ma, 150 ma, 500 ma and 15 a. Resistance multipliers are X 1, X 100 and X 10,000, with center-scale readings of 15, 1500 and 150,000 ohms. Covers -10 db to +65 db. Easy to build and fun to use. Attractive bakelite case with plastic carrying handle. Shpg. Wt. 6 lbs.

MODEL MM-1  
\$29.50

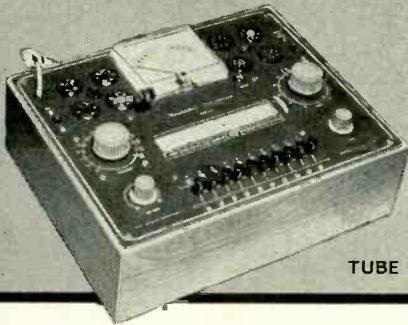

TUBE CHECKER

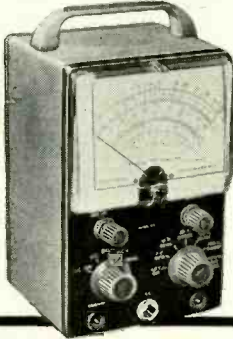

ETCHED  
CIRCUIT VTVM

*High quality  
test gear you  
will be  
proud to own*



HANDITESTER

*Priced low  
to fit your  
budget*



PICTURE TUBE  
CHECKER



20,000  
OHMS/VOLT VOM

### HEATHKIT RF SIGNAL GENERATOR KIT

Even a beginner can build this prealigned signal generator, designed especially for use in service work. Produces RF signals from 160 kc to 110 mc on fundamentals in five bands. Covers 110 mc to 220 mc on calibrated harmonics. Low impedance RF output in excess of 100,000 microvolts, is controllable with a step-type and continuously variable attenuator. Selection of unmodulated RF, modulated RF, or audio at 400 CPS. Ideal for fast and easy alignment of radio receivers, and finds application in FM and TV work as well. Thousands of these units are in use in service shops all over the country. Easy to build and a real time saver, even for the part-time service technician or hobbyist. Shpg. Wt. 8 lbs.

MODEL SG-8

**\$19.50**

### HEATHKIT LABORATORY RF GENERATOR KIT

Tackle all kinds of laboratory alignment jobs with confidence by employing the LG-1. It features voltage-regulated B+, double shielding of oscillator circuits, copper-plated chassis, variable modulation level, metered output, and many other "extras" for critical alignment work. Generates RF signals from 100 kc to 30 mc on fundamentals in five bands. Meter reads RF output in microvolts or modulation level in percentage. RF output available up to 100,000 microvolts, controlled by a fixed-step and a variable attenuator. Provision for external modulation where necessary. Buy and use this high-quality RF signal generator that may be depended upon for stability and accuracy. Shpg. Wt. 16 lbs.

MODEL LG-1

**\$48.95**

### HEATHKIT DIRECT-READING CAPACITY METER KIT

Here's a fast, simple capacity meter. A capacitor to be checked is merely connected to the terminals, the proper range selected, and the value read directly on the large 4½" panel meter calibrated in mmf and mfd. Ranges are 0 to 100 mmf, 1,000 mmf, .01 mfd, .1 mfd full scale. Not affected by hand capacity. Shpg. Wt. 7 lbs.

MODEL CM-1

**\$29.50**

# Heathkits...

By DAYSTROM

*are educational  
as well as functional*

### HEATHKIT "IN-CIRCUIT" CAPACI-TESTER KIT

With the CT-1 it is no longer necessary to disconnect one capacitor lead to check the part, you can check most capacitors for "open" or "short" right in the circuit. Fast and easy—to save your valuable time in the service shop or lab. Detects open capacitors from about 50 mmf up, so long as the capacitor is not shunted by excessively low resistance value. Will detect shorted capacitors up to 20 mfd (not shunted by less than 10 ohms). (Does not detect leakage.) Employs 60 cycles and 19 megacycle test frequencies. Electron beam "eye" tube used as indicator. Compact, easy-to-build, and inexpensive. Test leads included. Shpg. Wt. 5 lbs.

MODEL CT-1

**\$7.95**

*Use these  
kits for faster  
and more  
efficient testing*



RF SIGNAL GENERATOR



LABORATORY RF GENERATOR

DIRECT-READING CAPACITY METER



CONDENSER CHECKER



"IN CIRCUIT" CAPACI-TESTER



VISUAL-AURAL SIGNAL TRACER

### HEATHKIT CONDENSER CHECKER KIT

This handy instrument uses an electron beam "eye" tube as an indicator to measure capacity in ranges of .00001 to .005 mfd, .5 mfd, 50 mfd and 1000 mfd. Also measures resistance from 100 ohms to 5 megohms in two ranges. Checks paper, mica, ceramic and electrolytic capacitors. Selection of five polarizing voltages. Shpg. Wt. 7 lbs.

MODEL C-3

**\$19.50**

### HEATHKIT VISUAL-AURAL SIGNAL TRACER KIT

Although designed originally for radio receiver work, the T-3 finds application in FM and TV servicing as well. Features high-gain channel with demodulator probe, and low-gain channel with audio probe. Traces signals in all sections of radio receivers and in many sections of FM and TV receivers. Built-in speaker and electron beam eye tube indicate relative gain, etc. Also features built-in noise locator circuit. Provision for patching speaker and/or output transformer to external set. Shpg. Wt. 9 lbs.

MODEL T-3

**\$23.50**

HEATH COMPANY A Subsidiary of Daystrom, Inc. BENTON HARBOR 20, MICH.

NOVEMBER, 1957

69

### HEATHKIT IMPEDANCE BRIDGE KIT

The model IB-2A employs a Wheatstone Bridge, a Capacity Comparison Bridge, a Maxwell Bridge, and a Hay Bridge in one compact package. Measures resistance from 0.1 ohm to 10 megohms, capacitance from 100 mmf to 100 mfd, inductance from 0.1 mh to 100 h, dissipation factor (D) from 0.002 to 1, and storage factor (Q) from 0.1 to 1000. A 100-0-100 ua meter provides for null indications. The decade resistors employed are of 1% tolerance for maximum accuracy. Completely self-contained. Has built in power supply, 1000-cycle generator, and vacuum-tube detector. Special two-section CRL dial insures convenient operation. Instruction manual has entirely new schematic that clarifies circuit functions in various switch positions. A true laboratory instrument, that will provide you with many years of fine performance. Shpg. Wt. 12 lbs.

MODEL IB-2A

\$59<sup>50</sup>

### HEATHKIT "LOW RIPPLE" BATTERY ELIMINATOR KIT

This modern battery eliminator incorporates an extra low-ripple filter circuit so that it can be used to power all the newest transistor-type circuits requiring 0 to 12 volts DC,

and the new "hybrid" automobile radios using both transistors and vacuum tubes. Its DC output, at either 6 or 12 volts, contains less than .3% AC ripple. Separate output terminals are provided for low-ripple or normal filtering. Supplies up to 15 amps on 6 volt range or up to 7 amps on 12 volt range. Output is variable from 0 to 8 or 0 to 16 volts. Two meters constantly monitor output voltage and current. Will also double as a battery charger. Shpg. Wt. 23 lbs.

MODEL BE-5

\$39<sup>95</sup>

### HEATHKIT ISOLATION TRANSFORMER KIT

The model IT-1 is one of the handiest units for the service shop, home workshop or laboratory. Provides complete isolation from the power line. AC-DC sets may be plugged directly into the IT-1 without the chassis becoming "hot". Output voltage is variable from 90 volts to 130 volts allowing checks of equipment under adverse conditions such as low line voltage. Rated for 100 volt amperes continuously or 200 volt amperes intermittently. Panel meter monitors output voltage. Shpg. Wt. 9 lbs.

MODEL IT-1

\$16<sup>50</sup>

# Heathkits...

By DAYSTROM

*are designed with high-quality,  
name-brand components to  
insure long service life*

### HEATHKIT "Q" METER KIT

At this price the laboratory facilities of a Q Meter may be had by the average service technician or home experimenter. The Q Meter permits measurement of inductance from 1 microhenry to 10 millihenry, "Q" on a scale calibrated up to 250 full scale, with multipliers of 1 or 2, and capacitance from 40 mmf to 450 mmf  $\pm$  3 mmf. Built in oscillator permits testing components from 150 kc to 18 mc. Large 4½" panel meter is featured. Very handy for checking peaking coils, chokes, etc. Use to determine values of unknown condensers, both variable and fixed, compile data for coil winding purposes, or measure RF resistance. Also checks distributed capacity and Q of coils. No special equipment is required for calibration. A special test coil is furnished, along with easy-to-follow instructions. Shpg. Wt. 14 lbs.

MODEL QM-1

\$44<sup>50</sup>

### HEATHKIT REGULATED POWER SUPPLY KIT

Here is a power supply that will provide DC plate voltage and AC filament voltage for all kinds of experimental circuits. The DC supply is regulated for stability, and yet the amount of DC output voltage available from the power supply can be controlled manually from 0 up to 500 volts. At 450 volts DC output, the power supply will provide up to 10 ma of current, and provide progressively higher current as the output voltage is lowered. Current rating is 130 ma at 200 volts output. In addition to furnishing B+ the power supply also provides 6.3 volts AC at up to 4 amperes for filaments. Both the B+ output and the filament output are isolated from ground. Ideal unit for use in laboratory, home workshop, ham shack, or service shop. A large 4½" meter on the front panel reads output voltage or output current, selectable with a panel switch. Shpg. Wt. 17 lbs.

MODEL PS-3

\$35<sup>50</sup>

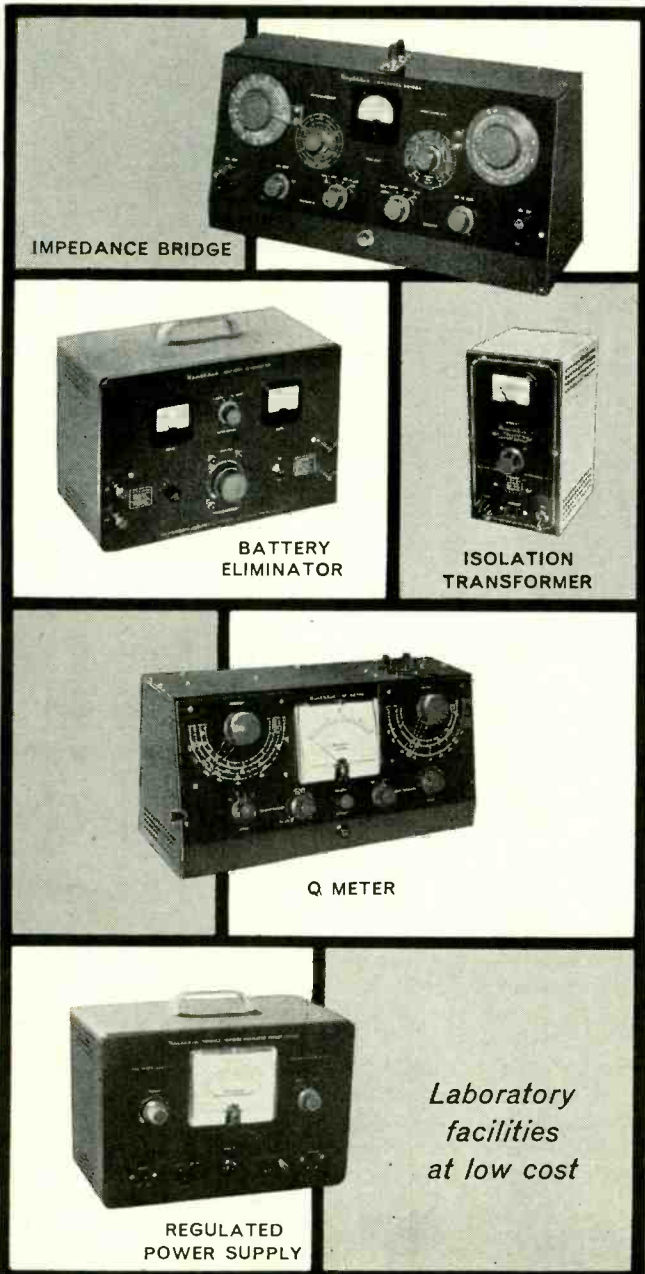

IMPEDANCE BRIDGE

BATTERY ELIMINATOR

ISOLATION TRANSFORMER

Q METER

REGULATED POWER SUPPLY

*Laboratory facilities  
at low cost*



*Terrific values  
in amateur  
equipment!*



**DX-20 TRANSMITTER**



**DX-35 TRANSMITTER**



**DX-100 TRANSMITTER**

**HEATHKIT DX-20 CW TRANSMITTER KIT**

The Heathkit model DX-20 "straight-CW" transmitter features high efficiency at low cost. It uses a single 6DQ6A tube in the final amplifier stage for plate power input of 50 watts. A 6CL6 serves as crystal oscillator, with a 5U4GB rectifier. It is an ideal transmitter for the novice, as well as the advanced-class CW operator. Single-knob band switching is featured to cover 80, 40, 20, 15, 11 and 10 meters. Pi network output circuit matches various antenna impedances between 50 and 1000 ohms and reduces harmonic output. Top-quality parts are featured throughout, including "potted" transformers, etc., for long life. It has been given full "TVI" treatment. Access into the cabinet for crystal changing is provided by a removable metal pull-out plug on the left end of the cabinet. Very easy to build from the complete step-by-step instructions supplied, even if you have never built electronic equipment before. If you appreciate a good, clean signal on the CW bands, this is the transmitter for you! Shpg. Wt. 18 lbs.

MODEL DX-20

**\$35<sup>95</sup>**

presents a most attractive appearance, and is designed for complete shielding to minimize TVI. Back panel control provides convenient switch selection of three different crystals, reached through access door at rear of cabinet. A most remarkable power package for the price. Complete step-by-step instructions with pictorial diagrams to assure your success in assembly. Shpg. Wt. 24 lbs.

MODEL DX-35

**\$56<sup>95</sup>**

**HEATHKIT DX-100 PHONE AND CW TRANSMITTER KIT**

Listen to any ham band between 160 meters and 10 meters and note how many DX-100 transmitters you hear! The number of these fine rigs now on the air testifies to the enthusiasm with which it has been accepted by the amateur fraternity. No other transmitter in this power class combines high quality and real economy so effectively. The DX-100 features a built in VFO, modulator and power supplies, complete shielding to minimize TVI, and pi network output coupling to match impedances from approximately 50 to 600 ohms. Its RF output is in excess of 100 watts on phone and 120 watts on CW, for a clean strong signal on all the ham bands from 10 to 160 meters. Single-knob band switching and illuminated VFO dial and meter face add real operating convenience. RF output stage uses a pair of 6146 tubes in parallel, modulated by a pair of 1625's. High quality components are used throughout, such as "potted" transformers, silver-plated or solid silver switch terminals, aluminum heat-dissipating caps on the final tubes, copper plated chassis, etc. This transmitter was designed exclusively for easy step-by-step assembly. Shpg. Wt. 107 lbs.

MODEL DX-100

**\$189<sup>50</sup>**

# Heathkits...

By DAYSTROM

*are designed by  
licensed ham-engineers,  
especially for you*

**HEATHKIT DX-35 PHONE AND CW TRANSMITTER KIT**

The DX-35 transmitter can be thought of as the "little brother" of the DX-100. It features both phone and CW operation on 80, 40, 20, 15, 11 and 10 meters. A single 6146 tube is used in the final amplifier stage to provide full 65 watt plate power input on CW, or controlled carrier modulation peaks up to 50 watts for phone operation. Modulator and power supplies are built right in and single knob band switching is combined with a pi network output circuit for complete operating convenience. The tight fitting cabinet

**FUNCTIONAL DESIGN . . .**

The transmitters described on this page were designed for the ham, by hams who know what features are desirable and needed. This assures you of the best possible performance and convenience, and adds much to your enjoyment in the ham shack.

*Automatically turns off  
transmitter and gives  
visual signal*



"AUTOMATIC"  
CONELRAD ALARM



GRID DIP METER

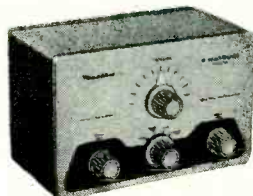

"Q" MULTIPLIER

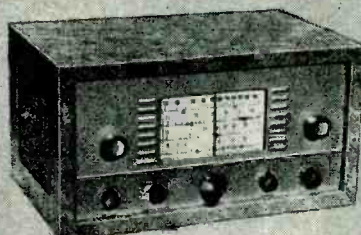

COMMUNICATIONS-TYPE  
RECEIVER

*An ideal receiver  
for the beginning  
ham or short  
wave listener*

#### HEATHKIT "AUTOMATIC" CONELRAD ALARM KIT

This conelrad alarm works with any radio receiver; AC-DC-transformer operated—or battery powered, so long as the receiver has AVC. Fully complies with FCC regulations for amateurs. When the monitored station goes off the air, the CA-1 automatically cuts the AC power to your transmitter, and lights a red indicator. A manual "reset" button reactivates the transmitter. Incorporates a heavy-duty six-ampere relay, a thyratron tube to activate the relay, and its own built-in power supply. A neon lamp shows that the alarm is working, by indicating the presence of B+ in the alarm circuit. Simple to install and connect. Your transmitter plugs into an AC receptacle on the CA-1, and a cable connects to the AVC circuit of a nearby receiver. A built-in sensitivity control allows adjustment to various AVC levels. Receiver volume control can be turned up or down, without affecting alarm operation. Build a Heathkit CA-1 in one evening and comply with FCC regulations now! Shpg. Wt. 4 lbs.

MODEL CA-1

\$13<sup>95</sup>

#### HEATHKIT "Q" MULTIPLIER KIT

The Heathkit Q Multiplier functions with any AM receiver having an IF frequency between 450 and 460 KC, that is not "AC-DC" type. It derives its power from the receiver, and needs only 6.3 volts AC at 300 ma (or 12 VAC at 150 ma) and 150 to 250 volts DC at 2 ma. Simple to connect with cable and plugs supplied. Adds additional selectivity for separating signals, or will reject one signal and eliminate heterodyne. A tremendous help on crowded phone and CW bands. Effective Q of 4000 for sharp "peak" or "null". Tunes any signal within IF band pass without changing the main receiver tuning dial. A convenient tuning knob on the front panel with vernier reduction between the tuning knob and the tuning capacitor gives added flexibility in operation. Uses a 12AX7 tube, and special high-Q shielded coils. Instructions for connecting to the receiver and operation are provided in the construction manual. A worthwhile addition to any communications, or broadcast receiver. It may also be used with a receiver which already has a crystal filter to obtain two simultaneous functions, such as peaking the desired signal with the crystal filter and nulling an adjacent signal with the Q Multiplier. Shpg. Wt. 3 lbs.

MODEL QF-1

\$9<sup>95</sup>

#### HEATHKIT GRID DIP METER KIT

A grid dip meter is basically an RF oscillator for determining the frequency of other oscillators, or of tuned circuits. Extremely useful in locating parasitics, neutralizing, identifying harmonics, coil winding, etc. Features continuous frequency coverage from 2 mc to 250 mc, with a complete set of prewound coils, and a 500 ua panel meter. Front panel has a sensitivity control for the meter, and a phone jack for listening to the "zero-beat." Will also double as an absorption-type wave meter. Shpg. Wt. 4 lbs.

MODEL GD-1B

\$19<sup>95</sup>

Low Frequency Coil Kit: Two extra plug-in coils to extend frequency coverage down to 350 kc. Shpg. Wt. 1 lb. No. 341-A. \$3.00

#### HEATHKIT ALL-BAND COMMUNICATIONS-TYPE RECEIVER KIT

This communications-receiver covers 550 kc to 30 mc in four bands, and provides good sensitivity, selectivity, and fine image rejection. Ham bands are clearly marked on an illuminated dial scale. Features a transformer-type power supply—electrical band spread—antenna trimmer—head-phone jack—automatic gain control and beat frequency oscillator. Accessory sockets are provided on the rear of the chassis for using the Heathkit model QF-1, Q Multiplier. Accessory socket is handy, also, for operating other devices that require plate and filament potentials. Will supply +250 VDC at 15 ma and 12.6 VAC at 300 ma. Ideal for the beginning ham or short wave listener. Shpg. Wt. 12 lbs.

MODEL AR-3

\$29<sup>95</sup>

(Less cabinet)

Cabinet: Fabric covered cabinet with aluminum panel as shown. Part no. 91-15A. Shpg. Wt. 5 lbs. \$4.95.

# Heathkits...

BY DAYSTROM

*are outstanding in performance  
and dollar value*

RADIO-ELECTRONICS



### HEATHKIT REFLECTED POWER METER KIT

The Heathkit reflected power meter, model AM-2, makes an excellent instrument for checking the match of the antenna transmission system, by measuring the forward and reflected power or standing wave ratio. The AM-2 is designed to handle a peak power of well over 1 kilowatt of energy and may be left in the antenna system feed line at all times. Band coverage is 160 meters through 2 meters. Input and output impedances for 50 or 75 ohm lines. No external power required for operation. Meter indicates percentage forward and reflected power, and standing wave ratio from 1:1 to 6:1. Another application for the AM-2 is matching impedances between exciters or R.F.I sources and grounded grid amplifiers. Power losses between transmitter output and antenna tuner may be very easily computed by inserting the AM-2 in the line connecting the two. No insertion loss is introduced into the feeder system, due to the fact that the AM-2 is a portion of coaxial line in series with the feeder system and no internal connections are actually made to the line. Complete circuit description and operation instructions are provided in the manual. Cabinet size is 7-3/8" x 4-1/16" x 4-5/8". Can be conveniently located at operating position. Shpg. Wt. 3 lbs.

MODEL AM-2

\$15<sup>95</sup>

### HEATHKIT VARIABLE FREQUENCY OSCILLATOR KIT

Enjoy the convenience and flexibility of VFO operation by obtaining the Heathkit model VF-1 Variable Frequency Oscillator. Covers 160-80-40-20-15-11 and 10 meters with three basic oscillator frequencies. Better than 10 volt average RF output on fundamentals. Plenty of output to drive most modern transmitters. It features voltage regulation for frequency stability. Dial is illuminated for easy reading. Vernier reduction is used between the main tuning knob and the tuning condenser. Requires a power source of only 250 volts DC at 15 to 20 milliamperes and 6.3 volts AC at 0.45 amperes. Extra features include copper-plated chassis, ceramic coil forms, extensive shielding, etc. High quality parts throughout. VFO operation allows you to move out from under interference and select a portion of the band you want to use without having to be tied down to only two or three frequencies through use of crystals. "Zero in" on the other fellow's signal and return his CQ on his own frequency! Crystals are not cheap, and it takes quite a number of them to give anything even approaching comprehensive coverage of all bands. Why hesitate? The model VF-1 with its low price and high quality will add more operating enjoyment to your ham activities. Shpg. Wt. 7 lbs.

MODEL VF-1

\$19<sup>50</sup>

# Heathkits...

By DAYSTROM

*are the answer for your electronics hobby.*

### HEATHKIT BALUN COIL KIT

The Heathkit Balun Coil Kit model B-1 is a convenient transmitter accessory, which has the capability of matching unbalanced coax lines, used on most modern transmitters, to balance lines of either 75 or 300 ohms impedance. Design of the bifilar wound balun coils will enable transmitters with unbalanced output to operate into balanced transmission line, such as used with dipoles, folded dipoles, or any balanced antenna system. The balun coil set can be used with transmitters and receivers without adjustment over the frequency range of 80 through 10 meters, and will easily handle power inputs up to 250 watts. Cabinet size is 9" square by 5" deep and it may be located any distance from the transmitter or from the antenna. Completely enclosed for outdoor installation. Shpg. Wt. 4 lbs.

MODEL B-1

\$8<sup>95</sup>

### HEATHKIT 6 OR 12 VOLT VIBRATOR POWER SUPPLY KITS

These little power supply kits are ideal for all portable applications with 6 volt or 12 volt batteries, when you are operating electronic equipment away from power lines. By replacing the power supplies of receivers, small public address systems, or even miniature transmitters with these units, they can be used with conventional 6 or 12 volt batteries. Use in boats, automobiles, light aircraft, or any field application. Each unit provides 260 volts DC output at up to 60 milliamperes. More than one power supply of the same model may be connected in parallel for increased current capacity at the same output voltage. Everything is provided in the kit, including a vibrator transformer, a vibrator, 6X4 or 12X4 rectifier, and the necessary buffer capacitor, hash filter, and output filter capacitor. Shpg. Wt. 4 lbs.

6 VOLT  
MODEL VP-1-6  
12 VOLT  
MODEL VP-1-12

\$7<sup>95</sup> Each

REFLECTED POWER METER

*Insure your "on the air" performance with these fine accessories.*

VARIABLE FREQUENCY OSCILLATOR

VIBRATOR POWER SUPPLY

BALUN COIL SET

HEATH COMPANY A Subsidiary of Daystrom, Inc. BENTON HARBOR 20, MICH.

NOVEMBER, 1957

73

### HEATHKIT ELECTRONIC IGNITION ANALYZER KIT

Previous electronic experience is not necessary to build this fine ignition analyzer. The construction manual supplied has complete step-by-step instructions plus large pictorial diagrams showing the exact placement and value of each component. All parts are clearly marked so that they are easily identified. The IA-1 is an ideal tool for engine mechanics, tune-up men, and auto hobbyists, since it traces the dynamic action of voltage in an ignition system on a cathode-ray tube screen. The wave form produced is affected by the condition of the coil, condenser, points, plugs, and ignition wiring, so it can be analyzed, and used as a "sign-post" to ignition system performance. This analyzer will detect inequality of spark intensity, a poor spark plug, defective plug wiring, breaker-point bounce, an open condenser, and allow setting of dwell-time percentage for the points. An important feature of this instrument is its ability to check dynamic performance, with the engine in operation (400 to 5000 RPM). It will show the complete engine cycle, or only one complete cylinder. Can be used on all types of internal combustion engines where breaker-points are accessible. Use it on automobiles, boats, aircraft engines, etc. Shpg. Wt. 18 lbs.

MODEL IA-1  
\$59<sup>95</sup>

### HEATHKIT PROFESSIONAL RADIATION COUNTER KIT

This Heathkit professional-type radiation counter is simple to build successfully, even if you have never built a kit before. Complete step-by-step instructions are combined with giant-size pictorial diagrams for easy assembly. By "building it yourself" you can have a modern-design, professional radiation counter priced far below comparable units. Provides high sensitivity with ranges from 0-100, 600, 6000 and 60,000 counts-per-minute, and 0-.02, .1, 1 and 10 miliroentgens-per-hour. Employs 900-volt bismuth tube in beta/gamma sensitive probe. Probe and 8-foot expandable cable included in kit price, as is a radiation sample for calibration. Use it in medical laboratories, or as a prospecting tool, and for civil defense to detect radioactive fallout, or other unknown radiation levels. Features a selectable time constant. Meter calibrated in CPM or mR/hour in addition to "beep" or "click" from panel-mounted speaker. Prebuilt "packaged" high voltage power supply with reserve capacity above 900 volt level at which it is regulated. Merely changing regulator tube type would allow use of scintillation probe if desired. Employs five tubes (plus a transistor) to insure stable and reliable operation. Kit price includes batteries. Shpg. Wt. 8 lbs.

MODEL RC-1  
\$79<sup>95</sup>

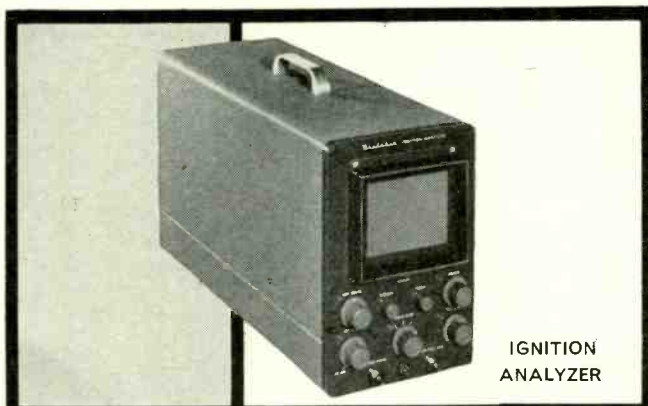

IGNITION ANALYZER



*Kit includes everything you need for construction — even batteries!*

RADIATION COUNTER

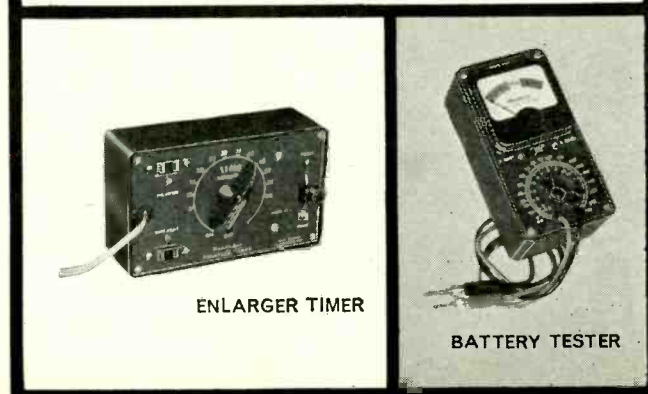

ENLARGER TIMER

BATTERY TESTER

# Heathkits...

By DAYSTROM

*are supplied with comprehensive instructions that eliminate costly mistakes and save valuable time*

### HEATHKIT ENLARGER TIMER KIT

The ET-1 is an easy-to-build electronic device to be used by amateur or professional photographers in timing enlarger operations. The calibrated dial on the timer covers 0 to 1 minute, calibrated in 5-second gradations. The continuously variable control allows setting of the "on" cycle of your enlarger, which is plugged into a receptacle on the front panel of the ET-1. A "safe light" can also be plugged in so that it is automatically turned "on" when the enlarger is turned "off." Handles up to 350 watts with built-in relay. All-electronic timing cycle insures maximum accuracy. Timer does not have to be reset after each cycle, merely flip lever switch to print, to repeat time cycle. A control is provided for initial calibration. Housed in a compact plastic case that will resist attack of photographic chemicals. A fine addition to any dark room. Shpg. Wt. 3 lbs.

MODEL ET-1  
\$11<sup>50</sup>

### HEATHKIT BATTERY TESTER KIT

The BT-1 is a special battery testing device that actually "loads" the battery under test (draws current from it) while it is being tested. Weak batteries often test "good" with an ordinary voltmeter but the built-in load resistance of the BT-1 automatically draws enough current from the battery to reveal its true condition. Simple to operate with "good-weak-replace" scale. Tests all kinds of dry cell batteries within ranges of 0-15 volts and 0-180 volts. Slide switch provides for either 10 ma or 100 ma load, depending on whether you're testing an A or B battery. Not only determines when battery is completely exhausted, but makes it possible to anticipate failure by noting weak condition. Ideal for testing dry cell hearing aid, flashlight, portable radio, and model airplane batteries. Test batteries in a way your customers can understand and stimulate battery sales. Shpg. Wt. 2 lbs.

MODEL BT-1  
\$8<sup>50</sup>



CRYSTAL RADIO



Now you can have radio  
wherever you go —  
with the portable  
that plays anywhere!



BROADCAST BAND RADIO



TRANSISTOR PORTABLE

### HEATHKIT CRYSTAL RADIO KIT

The Heathkit model CR-1 crystal radio is similar to the "crystal sets" of the early radio days except that it has been improved by the use of sealed germanium diodes and efficient "high-Q" coils. The sealed diodes eliminate the critical "cats whisker" adjustment, and the ferrite coils are much more efficient for greater signal strength. Housed in a compact plastic box, the CR-1 uses two tuned circuits, each with a variable tuning capacitor, to select the local station. It covers the broadcast band from 540 to 1600 kc. Requires no external power whatsoever. This receiver could prove valuable to emergency reception of civil defense signals should there be a power failure. The low kit price even includes headphones. Complete step-by-step instructions and large pictorial diagrams are supplied for easy assembly. The instruction manual also provides the builder with the basic fundamentals of signal reception so that he understands how the crystal receiver functions. An interesting and valuable "do-it-yourself" project for all ages. Shpg. Wt. 3 lbs.

MODEL CR-1  
\$7<sup>95</sup>

result of these efforts. Six name-brand (Texas Instrument) transistors were selected for extra good sensitivity and selectivity. A 4" by 6" PM speaker with heavy magnet was chosen to insure fine tone quality. The power supply was designed to use six standard size "D" flashlight cells because they are readily available, inexpensive, and because they afford extremely long battery life (between 500 and 1000 hours). Costs you no more to operate from batteries than what you pay for operating a small table-model radio from the power line. An unbreakable molded plastic was selected for cabinet material because of its durability and striking beauty. Circuit is compact and efficient, yet components are not excessively crowded. Transformers are prealigned so it is ready for service as soon as construction is completed. Has built in rod-type antenna for reception in all locations. Cabinet dimensions are 9" L x 8" H x 3 3/4" D. Comes in holiday gray, with gold-anodized metal speaker grille. Compare this portable, feature by feature, to all others on the market, and you'll appreciate what a tremendous dollar value it represents! Shpg. Wt. 4 lbs.

MODEL XR-1

\$34<sup>95</sup>

(Less batteries)  
(With cabinet)

# Heathkits...

By DAYSTROM

are easy and fun to build,  
and they let you learn  
by "doing-it-yourself"

### HEATHKIT TRANSISTOR PORTABLE RADIO KIT

Heath engineers set out to develop a "universal" AM radio, suitable for use anywhere. Their objective was a portable that would be as much "at home" inside as it is outside, and would feature top quality components for high performance and long service life. The model XR-1 is the

### HEATHKIT BROADCAST BAND RADIO KIT

This table-model broadcast radio is fun to build, and is a fine little receiver for your home. It covers the standard broadcast band from 550 to 1600 kc with good sensitivity and selectivity. The 5 1/2" PM speaker provides surprisingly good tone quality. High-gain IF transformers, miniature tubes, and a rod-type built in antenna, assure good reception in all locations. The power supply is transformer operated, as opposed to many of the economy "AC-DC" types. It's easy to build from the step-by-step instructions, and the construction manual includes information on operational theory, for educational purposes. Your success is assured by completely detailed information which also explains resistor and capacitor color codes, soldering techniques, use of tools, etc. A signal generator is recommended for final alignment. Shpg. Wt. 10 lbs.

MODEL BR-2

\$18<sup>95</sup>

(Less cabinet)

Cabinet: Fabric covered cabinet with aluminum panel as shown. Shpg. Wt. 5 lbs. Part no. 91-9A. \$4.95.

HEATH COMPANY A Subsidiary of Daystrom, Inc. BENTON HARBOR 20, MICH.

NOVEMBER, 1957

75

*protects against possible explosion and fire from undetected fuel vapor*



**FUEL VAPOR DETECTOR**

*detects electrolysis currents which cause deterioration of underwater metal fittings on your boat*



**ELECTROLYSIS DETECTOR**

*indicates condition and charge of batteries for safe cruising*



**BATTERY CHARGE INDICATOR**

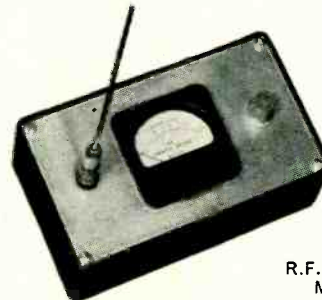

**R.F. POWER METER**

#### HEATHKIT FUEL VAPOR DETECTOR KIT

Protect your boat and its passengers against fire or explosion from undetected fuel vapor by building and using one of these fine units. The Heathkit Fuel Vapor Detector indicates the presence of fumes on a three-color "safe-dangerous" meter scale and immediately shows if it is safe to start the engine. A pilot light on the front panel shows when the detector is operating, and it can be left on continuously, or just used intermittently. A panel control enables initial calibration of the detector when installed. Features a hermetically-sealed meter with chrome bezel, and a chrome-plated brass panel. It is very simple to build and install, even by one not having previous experience. Models FD-1-6 (6 volts DC) and FD-1-12 (12 volts DC) operate from your boat batteries. The kit is complete in every detail, even to the inclusion of a spare detector unit. Shpg. Wt. 4 lbs.

6 volt  
MODEL FD-1-6  
12 volt  
MODEL FD-1-12

**\$35<sup>95</sup>**  
EACH

#### HEATHKIT BATTERY CHARGE INDICATOR KIT

The Heathkit model CI-1 Marine Battery Charge Indicator has been designed especially for the boat owner, although it has found use in service stations, power stations, and radio stations where banks of batteries are kept in reserve for emergency power. It is intended to replace the hydrometer method of checking storage batteries, and to eliminate the necessity for working with acid in small, below-decks enclosures. Now it is possible to check as few as one, or as many as eight storage batteries, merely by turning the switch and watching the meter. A glance at the meter tells you instantly whether your batteries are sufficiently charged for safe cruising. Dimensions are 2-7/8" W x 5-11/16" H x 2" D. Operates on either 6 or 12 volt systems using lead-acid batteries, regardless of size. Simple installation can be accomplished by the boat owner in fifteen minutes. Shpg. Wt. 3 lbs.

MODEL CI-1  
**\$16<sup>95</sup>**

#### HEATHKIT ELECTROLYSIS DETECTOR KIT

The Heathkit model ED-1 Electrolysis Detector indicates the extent of electrolysis currents between the boat's common ground and underwater fittings, except on boats having metal hulls. These currents, undetected, could

cause gradual corrosion and deterioration of the propeller or other metal fittings below the water line. It is particularly helpful when installing electrical equipment of any kind, or to determine proper polarity when power is obtained from a shore supply. Easy-to-build, the model ED-1 consists of a hermetically sealed, waterproof meter, special sensing plate, and sufficient wire to install, including the necessary hardware. Mounts on instrument panel where it can be easily seen. Requires no power for operation, and gives instant warning to guard your boat for a lifetime. Shpg. Wt. 2 lbs.

MODEL ED-1  
**\$9<sup>95</sup>**

#### HEATHKIT RF POWER METER KIT

The Heathkit RF Power Meter Kit is designed to sample the RF field in the vicinity of your transmitter, whether it be marine, mobile, or fixed. Output meter is merely placed in some location close to the transmitter, to pick up RF radiation from the antenna. Requires no batteries, electricity, nor direct connection to the transmitter. It provides you with a continuing indication of transmitter operation. You can easily detect if power is dropping off by comparing present meter readings with past ones. Operates with any transmitter having output frequencies between 100 kc and 250 mc, regardless of power. Sensitivity is 0.3 volts RMS full scale, and a special control on the panel allows for further adjustment of the sensitivity. Meter is a 200 ua unit, mounted on a chrome-plated brass panel. The entire PM-1 measures only 3 3/4" W x 6 1/4" L x 2" D. An easy way to put your mind at ease concerning transmitter operation. Shpg. Wt. 2 lbs.

MODEL PM-1  
**\$14<sup>95</sup>**

# Heathkits...

By DAYSTROM

*now offer you completely modern marine equipment with outstanding design features*

**HEATHKIT TRANSISTOR  
RADIO DIRECTION FINDER KIT**

The Heathkit Transistor Radio Direction Finder model DF-1 is a self-contained, self-powered, 6-transistor super heterodyne broadcast radio receiver incorporating a directional loop antenna, indicating meter, and integral speaker. It is designed to serve primarily as an aid to navigation when out of sight of familiar landmarks. It can be used not only aboard yachts, fishing craft, tugs, and other vessels which navigate either out of sight of land or at night, but also for the hunter, hiker, camper, fisherman, aviator, etc. It is powered by a 9-volt battery. (A spare battery is also included with the kit). The frequency range covers the broadcast band from 540 to 1600 kc and will double as a portable radio. A directional high-Q ferrite antenna is incorporated which is rotated from the front panel to obtain a fix on a station and a 1 ma meter serves as the null and tuning indicator. The controls consist of: tuning, volume and power (on-off), sensitivity, heading indicator (compass rose) and bearing indicator (antenna index). Overall dimensions are 7½" W x 5¾" H x 5¾" D. Supplied with slip-in-place mounting brackets, which allow easy removal from ship bulkheads or other similar places. Shpg. Wt. 5 lbs.

MODEL DF-1

**\$49.95**

*(Available after  
November 15)*

*use it for a  
radio-compass or  
as a portable radio*



**TRANSISTOR  
RADIO DIRECTION FINDER**

# Heathkits...

By DAYSTROM

*are sold only by direct mail,  
passing middleman  
profits on to you*



Pioneer in  
"do-it-yourself"  
electronics

**HOW CAN YOU MISS?**

The Heath Company maintains a technical consultation service, should you experience some sort of difficulty in construction or operation. Although only a very small percentage of our customers ever have occasion to use this service (usually only beginners in electronics) it is still reassuring to know that technical help is available when needed. A service department is also available, should you wish a complete factory check of operation and alignment or repair. After you build your first Heathkit you'll realize how easy it is.

## Free Catalog

Send for this  
informative booklet  
listing more than  
100 "do-it-yourself" kits.

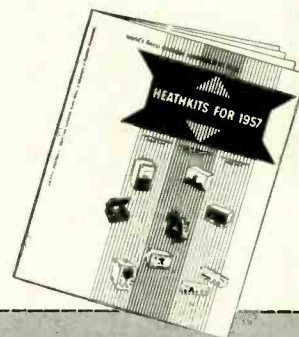

**HEATH COMPANY** *A Subsidiary of Daystrom, Inc.* **BENTON HARBOR 20, MICH.**

## ORDER BLANK

**NOTE: All prices subject to change without notice.**

Enclosed find ( ) check ( )  
money order for \_\_\_\_\_  
Please ship C.O.D. ( ) postage  
enclosed for \_\_\_\_\_ pounds.

**On Express orders do not include transportation charges—they will be collected by the express agency at time of delivery.**

**ON PARCEL POST ORDERS** include postage for weight shown. **ORDERS FROM APO'S** must include full remittance. All prices F.O.B. Benton Harbor, Mich.

Name \_\_\_\_\_

Address \_\_\_\_\_

City & Zone \_\_\_\_\_ State \_\_\_\_\_

(PLEASE PRINT)

**SHIP VIA**

- Parcel Post
- Express
- Freight
- Best Way

QUANTITY	ITEM	MODEL NO.	PRICE
		POSTAGE	
		TOTAL	

SEND FREE Heathkit Catalog

— announcing **vi-fi**

**VIDEO FIDELITY**  
*with*  
**SLENDER LINE**  
*design*

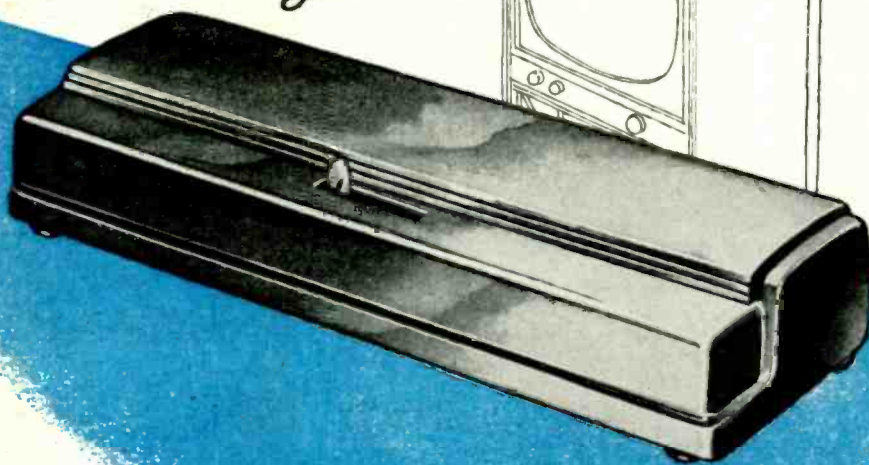

Fresh design ideas, new engineering concepts are combined in AMPHENOL's Vi-Fi indoor TV antenna.

VIDEO FIDELITY is here! "Slide Rule tuning and transformer coupling for strong, sharp pictures in difficult reception areas—no complicated switches!

SLENDER LINE STYLING Vi-Fi is as thin and as modern as the new TV sets—no bulk, no mass!

THREE WAY MOUNTING versatility: On top, and hidden or flush on back—no limitations!

Vi-Fi is available in VHF and VHF/UHF models, and in three color choices. It took two years to bring Vi-Fi to its present perfection—it will take you only two minutes to appreciate its many new advantages.

See your AMPHENOL Distributor for complete details.



AMPHENOL ELECTRONICS CORPORATION  
chicago 50, illinois

## TELEVISION

(Continued from page 61)

red and green phasing coils," Fuzzball hazarded.

"That's the general idea," Red replied. "We're through with the blue phasing coil for the time being, so we turn the blue amplitude control to zero."

Fuzzball's eyes lit up brightly. "So then we would turn up the red amplitude control, and resonate the red phasing coil for a peak?"

"Don't stop now, man."

"And then we would turn the red amplitude control to zero?"

"Keep with it," Red encouraged.

"And then turn up the green amplitude control, and resonate the green phasing coil for a peak?"

"Yes, and . . ."

"And finally turn down the green amplitude control to zero." Fuzzball finished triumphantly.

Red slapped Fuzz enthusiastically on the back. "I don't know how you do it," he said admiringly.

"You really want to know how he does it?" Bess asked out of the corner of her mouth.

Fuzzball's face clouded and his lip curled.

Red clapped his hand quick over Fuzzball's mouth. "Uh, uh!" he warned, "make sure brain is in gear before putting mouth in motion," he suggested.

"OK, OK," said Fuzzball, "I'll pretend I didn't hear that one, either."

"As before being so rudely interrupted," Red continued, "you then adjust the horizontal amplitude control to get a good straight line of blue dots." (Fig. 1-b.)

"I guess you pay attention only to the horizontal center row of dots," Fuzz suggested.

"You got a mind like an elephant," Red remarked. "You remembered from the vertical, didn't you?"

"Shucks, it ain't nothing," replied Fuzzball modestly. "What next?"

"Next you straighten the lines of green and red dots with the amplitude controls, and touch up the beam magnets."

"And then you have the horizontal converged," Fuzzball concluded.

"Not unless you have beginner's luck—you would, I suppose," Red replied. "No, you'll find you can't straighten the lines or dots completely with the amplitude controls. You go back and touch up the phase controls a bit."

"When do you stop all this back-and-forth?" demanded Fuzzball.

"There's a rule-of-thumb," Red replied. "If you can stand back 4 feet from the screen and *honestly* see no misconvergence, you can consider that you have done a job of work."

"By some strange coincidence, might you have another photo which you have tore out of R-E and showing this desirable situation?" asked Fuzzball softly.

"Put *that* in your pipe and smoke it," Red suggested, showing him Fig. 2.

"Yop, I see what you mean," mused

## TELEVISION

Fuzz. "Tell me, do you like dots or lines better for this little routine?"

"Well, now—that depends," Red replied. "When you're getting the parallel lineups, there's no question but what lines are easier to work with and less confusing than a series of broken dots. But then, on the other hand, when you are getting down to the final convergence, there's nothing like the little dots to show you that maybe you aren't quite as smart as your mother thinks you are."

"Would you maybe by some strange . . ."

"So put that in your pipe too. Have a good smoke," suggested Red. (Fig. 3).

"Yeah, I see what you mean," said Fuzz. "The crosshatch pattern doesn't show up this misconvergence nearly as plain as the little dots."

"You can just see the wheels turning in his busy little mind," Bess remarked.

Red spoke up quickly. "They say that grass doesn't grow on a busy street, but Fuzzball is the exception that proves the rule. Here's a buck, Fuzz—go get a haircut—I'll pay for it."

"Better give him four bucks," suggested Bess, "so he can get all four corners trimmed."

Red clapped his hand over Fuzz' half-opened mouth. "Get going," he suggested. END

## HOT COIL

I was called upon to service a new television receiver, just delivered, the complaint being no sound and no pix after 5 minutes. I changed all tubes that might cause the trouble but the receiver still cut out after 5 minutes. As the customer did not want the chassis pulled, leaving them without television over the week end, they decided to have it taken to the shop the following Monday and take a chance that it might give them some use by turning it off and on at intervals.

I called back the following Monday and at the door the customer greeted me with the fact that he had managed to get the receiver working continuously. I found a fan underneath it which sent cool air into the bottom of the chassis through the wire mesh covering the vent hole in the base of the cabinet, a console model. This ingenious remedy had suggested itself to this customer when I said that it cut out after it warmed up.

Pulling the chassis, the faulty component was found to be the first peaking coil following the video detector in this intercarrier receiver. This coil was wound on a resistor but one end of the coil wire had not been soldered to the resistor lead. As it was loosely wound, 5 minutes of heat from the chassis made it expand sufficiently to open the circuit feeding the video amplifier and the sound if strip. The blast of cool air had prevented this component from absorbing any heat and had allowed the set to function normally.—G. N. Carter

# Look . . . only the FLUXVALVE has 100% IQF\*

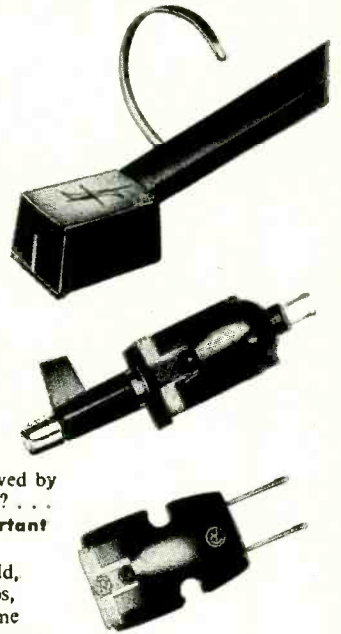

Choice of the *best* phonograph pickup can *only* be resolved by comparison! What is the yardstick? . . . How can you tell? . . . What do you look for? . . . the answer is 100% **Important Quality Features!**

PICKERING has had long experience in the cartridge field, supplying the finest quality products for recording studios, broadcast stations, wired music services, and high fidelity home music systems. As a result of this extensive experience, PICKERING has developed the **FLUXVALVE** . . . the *one* cartridge which incorporates *all* of the **Important Quality Features** . . . so necessary for high fidelity reproduction from records.

Before you choose a cartridge . . .  
**LISTEN AND COMPARE . . . demand 100% IQF!**

Feature	FLUXVALVE	Cartridge A	Cartridge B	Cartridge C
Frequency Response Flat 20-20,000 cps ± 2 db (See Curves on right)	YES 20 Points	NO 0 Points	NO 0 Points	NO 0 Points
Low Tracking Force, 2-4 grams	YES 20 Points	NO 0 Points	YES 20 Points	NO 0 Points
High Output, No Transformer Required	YES 10 Points	NO 0 Points	NO 0 Points	YES 10 Points
Replaceable Stylus	YES 10 Points	NO 0 Points	NO 0 Points	YES 10 Points
½ Mil Stylus	YES 15 Points	NO 0 Points	NO 0 Points	NO 0 Points
One Cartridge For LP's and 78's	YES 5 Points	NO 0 Points	NO 0 Points	YES 5 Points
Anti-Hum Design	YES 10 Points	YES 10 Points	YES 10 Points	YES 10 Points
Hermetically Sealed	YES 10 Points	NO 0 Points	NO 0 Points	NO 0 Points
<b>TOTAL POINT VALUE</b>	<b>100%</b>	<b>10%</b>	<b>30%</b>	<b>35%</b>

**THE FLUXVALVE** . . . chosen time and again as the *top* cartridge solely on the basis of *listening quality* . . . by panels of qualified experts . . . tests which have proven that it is *actually* less costly to own a **FLUXVALVE**.

The **FLUXVALVE** preserves the quality and prolongs the life of your record since there is complete absence of resonances throughout the audio range.

It may interest you to know that the **FLUXVALVE**, because of its ability to make *precise* and *reproducible* record measurements, is used for calibrating recording channels and record masters.

Make the IQF\* test today . . . listen to your favorite record reproduced with a **FLUXVALVE** . . . the *gentle* pickup.



**IMPORTANT QUALITY FEATURES**  
—so necessary for high fidelity reproduction from records.

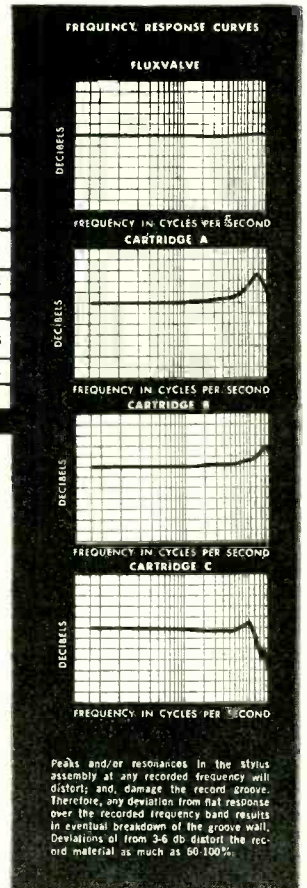

Series 194D UNIPOISE Pickup Arm with **FLUXVALVE** Cartridge.

Model 194D with 1 mil diamond "T-Guard" stylus \$59.85  
Model 194D with 2.7 mil diamond "T-Guard" stylus 59.85  
Model 194.5D with ½ mil diamond "T-Guard" stylus 65.85

**SERIES 3500 "T-Guard" STYLUS**

S-3510	1 mil Sapphire	6.00
S-3527	2.7 mil Sapphire	6.00
D-3510	1 mil Diamond	18.00
D-3527	2.7 mil Diamond	18.00
D-3505	½ mil Diamond	24.00

**SERIES 370 SINGLE FLUXVALVE**

370-15	1 mil Sapphire	17.85
370-25	2.7 mil Sapphire	17.85
370-1D	1 mil Diamond	29.85
370-2D	2.7 mil Diamond	29.85
370-5D	½ mil Diamond	35.85

**SERIES 350 TWIN FLUXVALVE**

350-DD	1 mil Diamond	36.00
350-500	½ mil Diamond	42.00
350-DS	1 mil Diamond/2.7 mil Sapphire	42.00
350-DD	1 mil Diamond/2.7 mil Diamond	54.00
350-0.5D	1 mil Diamond/½ mil Diamond	60.00



For those who can **hear** the difference FINE QUALITY HIGH FIDELITY PRODUCTS BY  
**PICKERING & COMPANY, INC., Oceanside, N. Y.**

**Model TD-55** — Terms:  
\$6.95 after 10 day trial then  
\$5.00 per month for 4 months.

OPERATING INSTRUCTIONS  
FOR MODEL TD-55  
TUBE TESTER



**Model TV-12** — Terms:  
\$22.50 after 10 day trial then  
\$10.00 per month for 5 months.



**Model TV-40**  
— Terms: \$3.85  
after 10 day trial  
then \$4.00 per  
month for 3  
months.

**Model TW-11** — Terms:  
\$11.50 after 10 day trial then  
\$6.00 per month for 6 months.

# SHIPPED ON APPROVAL NO MONEY WITH ORDER NO C.O.D.

## Superior's New Model TD-55 EMISSION TYPE TUBE TESTER

FOR

The Experimenter or Part-time Serviceman, who has delayed purchasing a higher priced Tube Tester.  
The Professional Serviceman, who needs an extra Tube Tester for outside calls.  
The busy TV Service Organization, which needs extra Tube Testers for its field men.

Speedy, yet efficient operation is accomplished by:

1. Simplification of all switching and controls.
2. Elimination of old style sockets used for testing obsolete tubes (26, 27, 57, 59, etc.) and providing sockets and circuits for efficiently testing the new Noval and Sub-Minar types.

You can't insert a tube in wrong socket. It is impossible to insert the tube in the wrong socket when using the new Model TD-55. Separate sockets are used, one for each type of tube base. If the tube fits in the socket it can be tested.

"Free-point" element switching system. The Model TD-55 incorporates a newly designed element selector switch system which reduces the possibility of obsolescence to an absolute minimum. Any pin may be used as a filament pin and the voltage applied between that pin and any other pin or even the "top-cap."

Checks for shorts and leakages between all elements. The Model TD-55 provides a super sensitive method of checking for shorts and leakages up to 5 Megohms between any and all of the terminals. Continuity between various sections is individually indicated. This is important, especially in the case of an element terminating at more than one pin. In such cases the element or internal connection often completes a circuit.

Elemental switches are numbered in strict accordance with R.M.A. specification. One of the most important improvements, we believe, is the fact that the 4 position fast-action snap switches are all numbered in exact accordance with the standard R.M.A. numbering system. Thus, if the element terminating in pin No. 7 of a tube is under test, button No. 7 is used for that test.

Complete with carrying case.....

**\$26<sup>95</sup>**  
NET

## Superior's New Model TV-40 PICTURE TUBE TESTER

Not a Gadget—Not a Make-Shift Adapter, but a Wired Picture Tube Tester With a Meter for Measuring Degree of Emission—at Only \$15.85

Of course you can buy an adapter for about \$5—which theoretically will convert your standard tube tester into a picture-tube tester; or a neon type instrument which sells for a little more and is supposed to be "as good as" a metered instrument. Superior does not make nor do they recommend use of C.R.T. adapters or neon gadgets because a Cathode Ray Tube is a very complex device, and to properly test it, you need an instrument designed exclusively to test C. R. Tubes and nothing else.

Tests ALL magnetically deflected tubes . . . in the set . . . out of the set . . . in the carton!

- Tests all magnetically deflected picture tubes from 7 inch to 30 inch types.
- Tests for quality by the well established emission method. All readings on "Good-Bad" scale.
- Tests for inter-element shorts and leakages up to 5 megohms.
- Test for open elements.

EASY TO USE: Simply insert line cord into any 110 volt A.C. outlet, then attach tester socket to tube base (ion trap need not be on tube). Throw switch up for quality test . . . read direct on Good-Bad scale. Throw switch down for all leakage tests.

Only.....

**\$15<sup>85</sup>**  
NET

## Superior's New Model TV-12 TRANS-CONDUCTANCE TUBE TESTER

TESTING TUBES

- Employs improved TRANS-CONDUCTANCE circuit. An in-phase signal is impressed on the input section of a tube and the resultant plate current change is measured. This provides the most suitable method of simulating the manner in which tubes actually operate in Radio & TV receivers, amplifiers and other circuits. Amplification factor, plate resistance and cathode emission are all correlated in one meter reading.
- NEW LINE VOLTAGE ADJUSTING SYSTEM. A tapped transformer makes it possible to compensate for line voltage variations to a tolerance of better than 2%.
- SAFETY BUTTON—protects both the tube under test and the instrument meter against damage due to overload or other form of improper switching.
- NEWLY DESIGNED FIVE POSITION LEVER SWITCH ASSEMBLY. Permits application of separate voltages as required for both plate and grid of tube under test, resulting in improved Trans-Conductance circuit.

### Extra Feature

Model TV-12 Also Tests Transistors!

A transistor can be safely and adequately tested only under dynamic conditions. The Model TV-12 will test all transistors in that approved manner, and quality is read directly on a special "transistor only" meter scale.

The Model TV-12 will accommodate all transistors including NPN's, PNP's Photo and Tetrodes, whether made of Germanium or Silicon, either point contact or junction contact types.

**\$72<sup>50</sup>**  
NET

Housed in hand-rubbed oak cabinet.....

## Superior's New Model TW-11 STANDARD PROFESSIONAL TUBE TESTER

- Tests all tubes, including 4, 5, 6, 7, Octal, Lockin, Hearing Aid, Thyatron, Miniatures, Sub-miniatures, Novals, Sub-minars, Proximity fuse types, etc.
- Uses the new self-cleaning Lever Action Switches for individual element testing. Because all elements are numbered according to pin-number in the RMA base numbering system, the user can instantly identify which element is under test. Tubes having tapped filaments and tubes with filaments terminating in more than one pin are truly tested with the Model TW-11 as any of the pins may be placed in the neutral position when necessary.
- The Model TW-11 does not use any combination type sockets. Instead individual sockets are used for each type of tube. Thus it is impossible to damage a tube by inserting it in the wrong socket.
- Free-moving built-in roll chart provides complete data for all tubes. All tube listings printed in large easy-to-read type.

NOISE TEST: Phono-jack on front panel for plugging in either phones or external amplifier will detect microphonic tubes or noise due to faulty elements and loose internal connections.

EXTRAORDINARY FEATURE: SEPARATE SCALE FOR LOW-CURRENT TUBES. Previously, on emission-type tube testers, it has been standard practice to use one scale for all tubes. As a result, the calibration for low-current types has been restricted to a small portion of the scale. The extra scale used here greatly simplifies testing of low-current types. Housed in hand-rubbed oak cabinet.....

**\$47<sup>50</sup>**  
NET

USE APPROVAL FORM ON NEXT PAGE



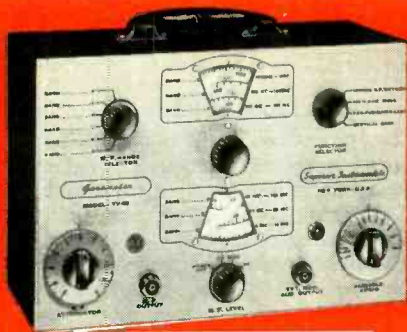

**Model TV-50** — Terms:  
\$11.50 after 10 day trial then  
\$6.00 per month for 6 months.



**Model 76**—Terms: \$6.95  
after 10 day trial then \$5.00  
per month for 4 months.



**Model 770-A** — Terms:  
\$3.85 after 10 day trial then  
\$4.00 per month for 3 months.



**Model 670-A** — Terms  
\$7.40 after 10 day trial then  
\$3.50 per month for 6 months

# TRY FOR 10 DAYS

before you buy! then if satisfactory pay in easy, interest free, monthly payments. See coupon below.

## Superior's New Model TV-50 **GENOMETER**

### 7 Signal Generators in One!

- ✓ R.F. Signal Generator for A.M.
- ✓ R.F. Signal Generator for F.M.
- ✓ Audio Frequency Generator
- ✓ Bar Generator
- ✓ Cross Hatch Generator
- ✓ Color Dot Pattern Generator
- ✓ Marker Generator

**R. F. SIGNAL GENERATOR:** 100 Kilocycles to 60 Megacycles on fundamentals and from 60 Megacycles to 180 Megacycles on powerful harmonics.

**VARIABLE AUDIO FREQUENCY GENERATOR:** Provides a variable 300 cycle to 20,000 cycle peaked wave audio signal.

**BAR GENERATOR:** Pattern consists of 4 to 16 horizontal bars or 7 to 20 vertical bars.

**CROSS HATCH GENERATOR:** Pattern consists of non-shifting horizontal and vertical lines interlaced to provide a stable cross-hatch effect.

**DOT PATTERN GENERATOR (FOR COLOR TV):** The Dot Pattern projected on any color TV Receiver tube by the Model TV-50 will enable you to adjust for proper color convergence.

**MARKER GENERATOR:** The following markers are provided: 189 Kc., 262.5 Kc., 456 Kc., 600 Kc., 1000 Kc., 1400 Kc., 1600 Kc., 2000 Kc., 2500 Kc., 3579 Kc., 4.5 Mc., 5 Mc., 10.7 Mc., (3579 Kc. is the color burst frequency.)

Complete with shielded leads.....

**\$47.50**  
NET

## Superior's New Model 670-A **SUPER-METER**

### A Combination VOLT-OHM MILLIAMMETER PLUS Capacity, Reactance, Inductance and Decibel Measurements.

**ADDED FEATURE:** Built in ISOLATION TRANSFORMER reduces possibility of burning out meter through misuse.

#### SPECIFICATIONS:

**D.C. VOLTS:** 0 to 7.5/15/75/150/750/1,500/7,500 Volts  
**A.C. VOLTS:** 0 to 15/30/150/300/1,500/3,000 Volts  
**OUTPUT VOLTS:** 0 to 15/30/150/300/1,500/3,000 Volts  
**D.C. CURRENT:** 0 to 1.5/15/150 Ma. 0 to 1.5/15 Amperes  
**RESISTANCE:** 0 to 1,000/100,000 Ohms 0 to 10 Megohms  
**CAPACITY:** .001 to 1 Mfd. 1 to 50 Mfd. (Good-Bad scale for checking quality of electrolytic condensers.)

**REACTANCE:** 50 to 2,500 Ohms 2,500 Ohms to 2.5 Megohms

**INDUCTANCE:** .15 to 7 Henries 7 to 7,000 Henries

**DECIBELS:** -6 to +18 +14 to +38

+34 to +58

Complete with test leads.....

**\$28.40**  
NET

## Superior's New Model **76**

- ✓ IT'S A CONDENSER BRIDGE
- ✓ IT'S A RESISTANCE BRIDGE
- ✓ IT'S A SIGNAL TRACER
- ✓ IT'S A TV ANTENNA TESTER

#### SPECIFICATIONS

✓ **CAPACITY BRIDGE SECTION** 4 Ranges: .00001 Microfarad to .005 Microfarad; .001 Microfarad to .5 Microfarad; .1 Microfarad to 50 Microfarads; 20 Microfarads to 1000 Microfarads. Will also measure the power factor of all condensers from .1 to 1000 Microfarads.

✓ **RESISTANCE BRIDGE SECTION** 2 Ranges: 100 ohms to 50,000 ohms; 10,000 ohms to 5 megohms.

✓ **SIGNAL TRACER SECTION** With the use of the R.F. and A.F. Probes included with the Model 76, you can make stage gain measurements, locate signal loss in R.F. and Audio stages, localize faulty stages, locate distortion and hum, etc.

✓ **TV ANTENNA TESTER SECTION** Loss of sync., snow and instability are only a few of the faults which may be due to a break in the antenna, so why not check the TV antenna first? Locates a break in any TV antenna and measures the location of the break in feet from the set terminals.

Complete with R.F. and A.F. probes and test leads.....

**\$26.95**  
NET

## Superior's New Model 770-A **POCKET-SIZED VOLT-OHM MILLIAMMETER**

● USING THE NEW "FULL-VIEW" METER 71% MORE SCALE AREA—Occupies exactly the same space used by the older standard 2 1/2" Meters, yet provides 71% more scale area. As a result, all calibrations are printed in large easy-to-read type and for the first time it is now possible to obtain measurements instead of approximations.

● Compact—measures 3 1/8" x 5 7/8" x 2 1/4". ● Uses "Full View" 2% accurate, 850 Microampere D'Arsonval type meter. ● Housed in round-cornered, molded case. ● Beautiful black etched panel.

**Specifications:** 6 A.C. VOLTAGE RANGES: 0-15/30/150/300/1500/3000 Volts.

6 D.C. VOLTAGE RANGES: 0-7.5/15/75/150/750/1500 Volts. 2

RESISTANCE RANGES: 0-10,000 Ohms, 0-1 Megohm. 3 D.C.

CURRENT RANGES: 0.15/150 Ma., 0-1.5 Amps. 3 DECIBEL

RANGES: -6 db to + 18 db, + 14 db to + 38 db,

+ 34 db to + 58 db.

Complete with test leads.....

**\$15.85**  
NET

We invite you to try before you buy any of the models described on this and the preceding page. If after a 10 day trial you are completely satisfied and decide to keep the Tester, you need send us only the down payment and agree to pay the balance due at the monthly indicated rate.

### **NO INTEREST OR FINANCE CHARGES ADDED!**

If not completely satisfied, you are privileged to return the Tester to us, cancelling any further obligation.

### **MOSS ELECTRONIC DISTRIBUTING CO., INC.** Dept. D-401, 3849 Tenth Ave., New York 34, N. Y.

Please send me the units checked. I agree to pay down payment within 10 days and to pay the monthly balance as shown. It is understood there will be no finance or interest charges added. It is further understood that should I fail to make payment when due, the full unpaid balance shall become immediately due and payable.

Name .....

Address .....

City ..... Zone ..... State .....

All Prices net. F.O.B. N.Y.C.

- Model TV-11 ..... Total Price \$47.50  
\$11.50 within 10 days. Balance \$6.00  
monthly for 6 months.
- Model 76 ..... Total Price \$26.95  
\$6.95 within 10 days. Balance \$5.00  
monthly for 4 months.
- Model TD-55 ..... Total Price \$26.95  
\$6.95 within 10 days. Balance \$5.00  
monthly for 4 months.
- Model TV-50 ..... Total Price \$47.50  
\$11.50 within 10 days. Balance \$6.00  
monthly for 6 months.
- Model TV-40 ..... Total Price \$15.85  
\$3.85 within 10 days. Balance \$4.00  
monthly for 3 months.
- Model 670-A ..... Total Price \$28.40  
\$7.40 within 10 days. Balance \$3.50  
monthly for 6 months.
- Model 770-A ..... Total Price \$15.85  
\$3.85 within 10 days. Balance \$4.00  
monthly for 3 months.
- Model TV-12 ..... Total Price \$72.50  
\$22.50 within 10 days. Balance \$10.00  
monthly for 5 months.

# PRECISION

...manufacturers of fine electronic test instruments for over 25 years...

INTRODUCES

**P A C O**

quality test instruments in kit form

For the first time— a line of test instrument kits engineered and produced under the auspices of a major test equipment manufacturer... and conveniently available directly from your own local electronic parts distributor.

**PRECISION's** 25 years of experience is your assurance of **PACO's** superior quality, styling, performance and value.

**COMING SOON...**

Model G-30 — RF Signal Generator  
Model Z-80 — Audio-RF Signal Tracer  
Model M-40 — High Sensitivity V-O-M

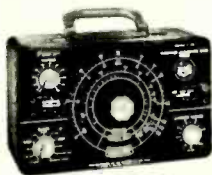

**Model C-20**  
RESISTANCE — CAPACITY-RATIO BRIDGE KIT  
10 mmfd to 2000 mfd  
1/2 ohm to 200 megohms.  
Net Price: \$20.95

Available and on display at leading electronic parts distributors. Write for descriptive bulletin.

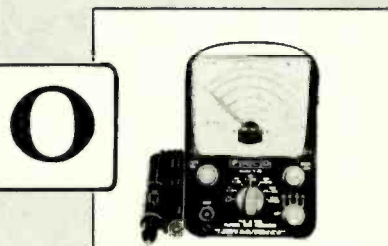

**Model V-70**  
VACUUM TUBE VOLTMETER KIT  
wide-range • peak to peak.  
Net Price: \$31.50



**Model B-10: BATTERY ELIMINATOR KIT**  
• less than 0.3% ripple output  
• no external filter adaptors required  
Net Price: \$41.95



**Model S-50**  
5" CATHODE RAY OSCILLOSCOPE KIT  
push-pull vertical and horizontal amplifiers.  
Net Price: \$47.50

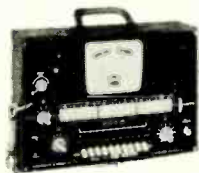

**Model T-60: TUBE CHECKER KIT**  
full free-point lever selector system  
Net Price: \$36.75  
Matching, hinged, removable cover;  
Net Price: \$3.95

**P A C O**

**ELECTRONICS CO., INC.**

70-31 84th Street, Glendale 27, L. I., N. Y.

A DIVISION OF **PRECISION** Apparatus Company, Inc.

Export: 458 Broadway, New York 13, New York  
Canada: Atlas Radio Corp., Ltd., 50 Wingold Ave., Toronto 10, Ont.

## TELEVISION

### POSITIVE GRID

The complaint on a Zenith ZOJ22 was one of horizontal frequency drift after the receiver had been on for about 2 hours. At this time the horizontal hold also became very sensitive.

After checking the horizontal oscillator, horizontal frequency control, and horizontal phase detector tubes, the set was checked for defective components in these same circuits, all without finding the trouble.

Checking further, approximately 1 volt positive was found on the grid of the afc tube (1/2 6SN7). The plate voltage was below normal also. When the tube was pulled out of the socket, the voltage on the grid went up to 20. Taking one part out of the circuit at a time, the voltage was found to be coming from two 100,000-ohm resistors in series, feeding the grid of the afc tube. When all parts were taken off both ends of the resistors, the voltage was still present. One of the resistors was tied between vacant pins 2 and 6 of the 6W4 tube, and the voltage was coming from pin 2. The socket was checked, and then the tube. The culprit: the 6W4.

Checking the construction of the tube, I found pin 2 was used inside the tube as a support for the mica spacer and was located directly under the plate structure. My guess as to the trouble—leaky mica.

A new tube was inserted, and the set worked fine. But just in case the next tube gets the same trouble-making idea, that resistor is now located between two terminals of a nice healthy tie post.—Robert A. Hillskemper



This tube may look like new, but it's substandard—masquerading as new and unused. For the past 23 months RADIO-ELECTRONICS has been conducting a campaign to combat this fraudulent practice. We have no objection to anyone selling or advertising used or substandard tubes—PROVIDED THEY ARE SO LABELED OR ADVERTISED. But we are old-fashioned enough to think that when you see a mail order ad which offers "guaranteed tubes" or even just "tubes," you should expect that the ad means brand-new, unused tubes, even if it doesn't specifically say so.

To be certain that RADIO-ELECTRONICS readers are not fooled, we do not accept advertising which tends to be misleading—but insist that ads specify exactly what the tubes are—new and unused, or used tubes, seconds, etc. This policy has been in effect since our January 1956 issue.

**NEW**

**ONLY  
PUBLICATION  
OF ITS KIND!**

*Howard W. Sams* 1958

# Test Equipment Annual



**MOST COMPLETE AND AUTHORITATIVE  
GUIDE TO TEST INSTRUMENTS EVER PUBLISHED**

**Nothing else like it!** A completely NEW and DIFFERENT publication bringing you the most needed, most requested information about all types of Test Equipment and accessories. A 100% practical guide for anyone who uses test equipment—written in down-to-earth language and profusely illustrated.

## 8 FACT-PACKED SECTIONS:

- Test Equipment Methods, Measurement Analysis and General Information
- Using Test Equipment for Alignment
- Using Test Equipment for Troubleshooting
- Use and Selection of Test Equipment for Color TV
- Test Equipment for Special Applications
- Test Equipment Maintenance
- Questions and Answers About Test Equipment

You get *all* the useful information you need on theory, operation and maintenance of Test Equipment. Each section of the book is packed with data that will save you time and money—techniques to make your present equipment more versatile and valuable—full information about new equipment designed for service of new chassis and components.

*Plus*

Complete specifications on over 300 current models of test equipment and accessories! Includes full manufacturers' specifications—and more than 300 photos of equipment. For the first time anywhere—a complete presentation of test equipment grouped by logical instrument type classification (not by brand name). Covers *everything*:

- Pattern Generators
- AM, FM, Sweep & Marker Generators
- Audio & Square-Wave Generators
- Oscilloscopes
- VOM's
- VTVM's
- Power Meters
- Field Strength Meters
- Decade & Substitution Boxes
- Power Supply Equipment
- Tube Testers
- Transistor Testers
- CRT Testers
- Component Testers
- Other Meters & Probes
- Other Bench Equipment

**ALL THE FACTS YOU WANT!**

*Only*  
**\$1.00**

**THE BIGGEST DOLLAR'S WORTH  
OF USEFUL, PRACTICAL DATA  
ON TEST EQUIPMENT  
EVER MADE AVAILABLE!**

**LIMITED EDITION**

**Order Your Copy Today!**

**ONLY  
\$1.00**

## HOWARD W. SAMS & CO., INC.

Order from your Parts Jobber today, or mail to Howard W. Sams & Co., Inc., Dept. 2-LL7, 2201 East 46th St., Indianapolis 5, Ind.

Send \_\_\_\_\_ copy(ies) of "Test Equipment Annual."

My (check) (money order) for \$\_\_\_\_\_ is enclosed

Name \_\_\_\_\_

Address \_\_\_\_\_

City \_\_\_\_\_ Zone \_\_\_\_\_ State \_\_\_\_\_

(outside U. S. A. priced slightly higher)



**HOWARD W. SAMS & CO., INC.**  
Indianapolis 5, Indiana

# 7- TRANSISTOR POCKET RADIO



*Superhet design features push-pull output and slip-in-your-pocket size*

By HOWARD GRANOFF

FOR many years I have followed the many articles on transistors and transistorized devices such as radio receivers. Many attempts have been made to reduce size while still preserving the desirable features found in commercial portables. Something usually has to be sacrificed.

My main goal was to include in one package all those features that are desirable in a portable radio receiver. The final result was a 4 x 3 x 1-inch receiver, with good operating economy, high sensitivity, sharp selectivity and more than enough power to drive a 2½-inch PM speaker.

The set is a complete superheterodyne containing seven transistors and one crystal diode (see Fig. 1). The total cost of the transistors and diode is about \$13. Three of the transistors are 2N112's. One functions as a converter, the other two as if amplifiers. A 1N34 crystal diode operates as both avc and

(Continued on page 93)

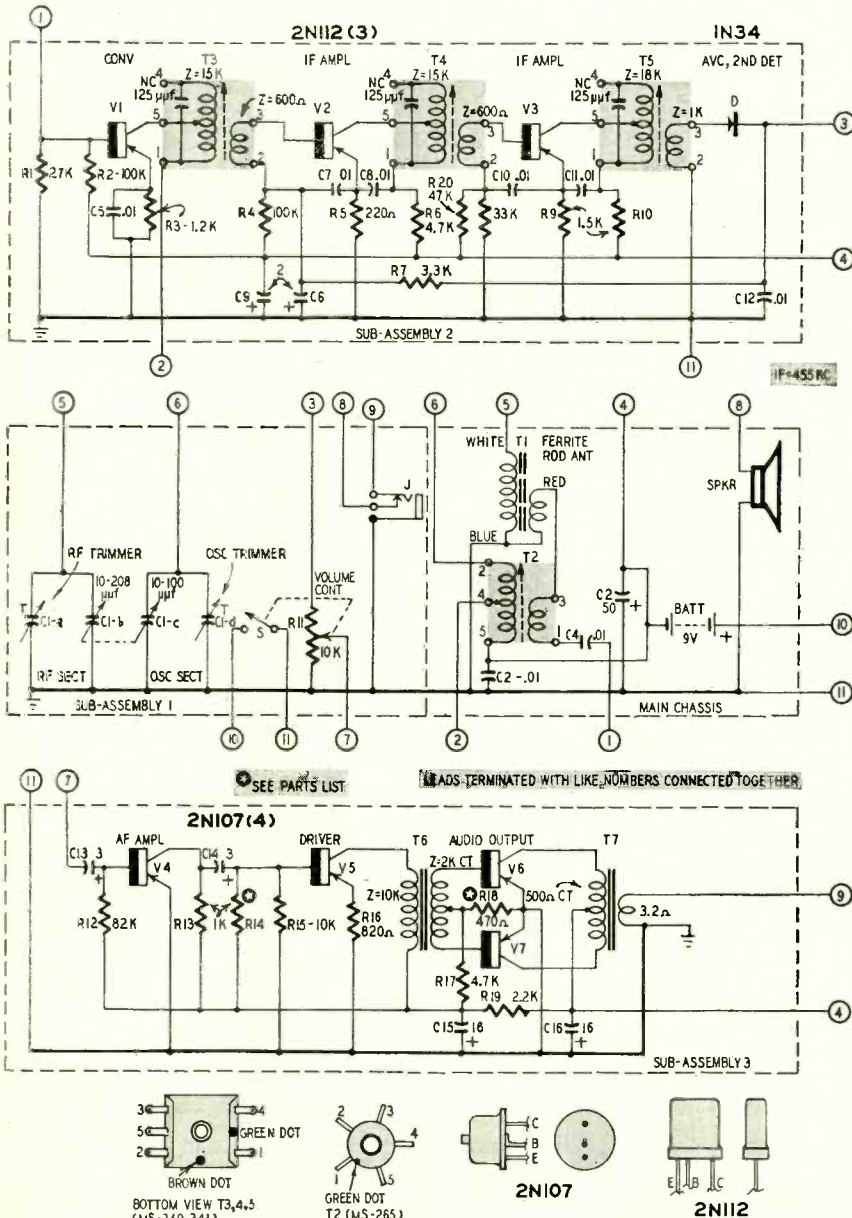

Fig. 1—Circuit of the receiver's four sections. Unmarked 33K resistor is R8 and the .01 capacitor C2 should be C3.

# Build the Best - build ALLIED knight®-kits



the finest electronic equipment in money-saving kit form

### LOWEST COST

ALLIED'S giant buying power passes biggest savings on to you—you do the easy assembly and your finished instrument equals the performance and appearance of equipment selling for several times the low KNIGHT-KIT cost. Your savings are BIG.

### EASIEST TO BUILD

KNIGHT-KIT "Step-and-Check" instruction manuals with wall-sized picture diagrams are marvels of clarity—it's like having a good instructor at your side. No experience required—you can easily build any KNIGHT-KIT and get professional results.

### LATEST DESIGN

Each ALLIED KNIGHT-KIT incorporates the very latest circuitry for top-quality performance. Tried and proved professional design and the use of premium quality parts throughout help insure your building success to bring you quality results.

### COMPLETE KIT SELECTION:

- HI-FI
- HOBBY
- INSTRUMENT
- AMATEUR



**MONEYBACK GUARANTEE.** When properly assembled, KNIGHT-KITS fully meet published specifications or we refund your money in full.

**EASY TERMS.** If your KNIGHT-KIT order comes to \$45.00 or more, you can make your purchase on our attractive Easy Payment Plan.

## High Fidelity Everyone Can Afford

- World's Finest Hi-Fi Kits
- Custom-Styled
- Easiest to Build Hi-Fi
- Money-Saving



### knight-kit High Fidelity FM-AM Tuner Kit

Model Y-787

**\$49.95**

Only \$4.99 down

- Latest Time-Saving Printed Circuit Design
- Flywheel Tuning
- Automatic Frequency Control
- 2.5  $\mu$ V FM Sensitivity
- True High Fidelity Response
- Beautiful Custom-Styled "Space Saver" Case

The best-looking, best-performing FM-AM tuner kit your money can buy! Carefully designed for quick, easy construction—a tuner you'll enjoy assembling and be proud to own, both for its amazing musical performance and outstanding beauty. Covers the full AM broadcast band and 88 to 108 mc FM. On FM, sensitivity is a remarkable 2.5 microvolts for 20 db of quieting; hum and noise, -60 db; IF bandwidth, 200 kc at 50% down on curve; response,  $\pm$  0.5 db, 20-20,000 cps. On AM, sensitivity is 3 microvolts for 10 db signal-to-noise ratio; IF bandwidth, 8 kc at 50% down on curve; response, 20-8000 cps. Outstanding features include: Inertia Flywheel Tuning for effortless, accurate tuning; Automatic Frequency Control (plus AFC disabling) to "lock-in" FM stations; printed circuit board (with most of the kit wiring already done for you) assures time-saving, error-free assembly; pre-aligned RF and IF coils; tuned RF stage on FM; drift-compensated oscillator; neon glow tuning pointer; cathode follower output; two output jacks—one for recorder, one for amplifier; rotatable built-in ferrite antenna for AM. Includes beautiful French-gray case with chrome-finished tapered feet, 4 x 13 x 8". Ideal for use with 18, 20 or 30 watt KNIGHT-KIT amplifiers. Ready for easy assembly. Shpg. wt., 12 lbs.

Model Y-787. FM-AM Tuner Kit. Net only ..... \$49.95



### knight-kit 18-Watt Complete Hi-Fi Amplifier Kit

Model Y-786

**\$39.95**

Only \$3.99 down

- The Last Word in Custom Hi-Fi Styling
- Full 18 Watts with Superb Hi-Fi Specifications
- 8 Inputs for Every Desired Signal Source
- Printed Circuit Switch and Printed Circuit Boards
- Full Equalization for All Record Types

Here is a custom-styled, easy-to-build complete Hi-Fi amplifier at a price that defies comparison. Delivers full 18 watts output with wide-range, flat frequency response for true hi-fi reproduction. Features 8 inputs for every possible signal source, including NARTB equalized tape head input. At full 18 watts output, distortion is only 0.5%; uses new RCA 6973 hi-fi output tubes. Frequency response is  $\pm$  1 db, 20-30,000 cps; tape head and magnetic cartridge sensitivity, 5 microvolts for 18 watts output; hum and noise level better than 60 db below 18 watts. Output taps for 4, 8 or 16 ohm speakers. Controls: Input and Record Equalization; Bass Boost and Attenuate; Treble Boost and Attenuate; Volume. Simplest assembly is made possible through the use of an exclusive printed circuit switch and two printed circuit boards—most of the kit wiring is already done for you. With custom-styled French-gray "space-saver" case on tapered feet finished in chrome, 4 x 13 x 8". Complete with case, tubes, all parts, and step-by-step instructions, for easy, error-free assembly. Shpg. wt., 15 lbs.

Model Y-786. 18-Watt Hi-Fi Amplifier Kit. Net only ..... \$39.95

**EASY TERMS TO FIT YOUR BUDGET.** ALLIED KNIGHT-KITS may be purchased under our Easy Payment Plan. Your order need total only \$45.00 or more—only 10% down, small monthly payments thereafter. No red tape—fast handling assured.

*Our 37th Year*



© Registered Trade-Mark of Allied Radio Corporation

ORDER FROM **ALLIED RADIO** 100 N. WESTERN AVE. • CHICAGO 80, ILL.

# Now you can have Custom-Styled Hi-Fi in **ALLIED**



## knight-kit 30-Watt Complete Hi-Fi Amplifier Kit

Model Y-762

**\$76<sup>95</sup>**

- Full Equalization,  $\pm 1/2$  db of Recommended Accuracy
- Printed Circuit Switches • Printed Circuit Boards
- 8 Inputs For Every Possible Signal Source
- Full 30 Watts Output • Custom-Styled Beauty

Only \$7.69 down

Comparable to the best in Hi-Fi—at far less cost! Deluxe features include: Linear-deluxe Williamson-type circuit for flawless response; equalization for all records within  $1/2$  db of recommended accuracy; 2 exclusive new printed circuit switches in preamp section (no complex wiring to do); 3 printed circuit boards for time-saving, error-free assembly; separate, continuously variable Level and Loudness controls; use of premium 12A Y7 tube for low noise and hum; DC on all filaments of preamp tubes; exclusive A-AB-B speaker selector switch (use speakers of mixed impedances without mismatch). 8 inputs: Tape Head direct; G.E. and Pickering cartridges; Ceramic cartridge; Microphone; Auxiliary; Tape Preamp; Tuner (with separate Level Set control). Power amplifier response,  $\pm 1/2$  db, 15-100,000 cps at full 30 watt level; distortion—harmonic, 0.55% at 30 watts—1M, 0.74% at 20 watts. Separate Bass and Treble controls; rumble filter switch; variable damping. Output, 8 and 16 ohms. With smart French-gray cabinet, 4 x 15 x 15". Ready for easy, money-saving assembly. Shpg. wt., 32 lbs.

Model Y-762. 30-Watt Hi-Fi Amplifier Kit. Net only..... **\$76.95**

## knight-kit High Fidelity FM Tuner Kit

Model Y-751

**\$38<sup>95</sup>**

- Authentic High Fidelity FM Response
- Flywheel Tuning • Automatic Frequency Control
- Printed Circuit • Pre-Adjusted Coils and IF's
- 4 Microvolt Sensitivity Guaranteed

Only \$3.89 down

Here is top value in creative engineering, impressive hi-fi performance and distinctive design—a tuner you'll be proud to build and own. Covers the full FM band, 88 to 108 mc. Features Automatic Frequency Control (with disabling feature) to "lock-in" stations and prevent drift; Inertia Flywheel Tuning for velvet-smooth, accurate station selection; pre-adjusted RF coils; pre-aligned IF's; cascode broad-band RF amplifier; drift-compensated oscillator; neon bulb pointer. All critical wiring is already done for you in the form of a printed circuit board—assembly is simple. Sensitivity is 4 microvolts for 20 db of quieting across entire band; output, 2 volts at 1000 microvolts input; IF bandwidth, 200 kc; response, 20-20,000 cps. with only 0.6% distortion. Output jacks for amplifier and tape recorder; cathode follower output. Ideal for use with the KNIGHT-KIT amplifiers, or any amplifier with phono-tuner switch. Features custom-styled case in French-gray, with tapered chrome-finished feet, 4 x 13 x 8". Includes all parts, tubes and step-by-step instructions for easy assembly. Shpg. wt., 12 lbs.

Model Y-751. Hi-Fi FM Tuner Kit. Net only..... **\$38.95**

## knight-kit Deluxe 3-Way Speaker System Kit

Model Y-937

**\$89<sup>50</sup>**

Only \$8.95 down

- Pre-Finished "Quik-Craft" Corner Enclosure
- Klipsch Designed and Licensed
- Famous Knight 12" 3-Way Speaker
- Easy to Assemble—Top Hi-Fi Quality
- Choice of Enclosure Finishes

Deluxe quality high fidelity speaker system at a money-saving low price. Easy to assemble—all you need is a screwdriver. System includes KNIGHT "Quik-Craft" corner-type folded-horn enclosure kit, and the famous-value KNIGHT 3-Way 12-inch speaker. Just assemble the enclosure—no finishing required—all surfaces are finished in hand-rubbed Korina blonde, mahogany or walnut. The speaker is the new 3-way type: 12" woofer cone for bass (full  $1 3/4$  pound woofer magnet), conical radiator for mid-frequencies, built-in compression-type tweeter (with wired

level control and calibrated dial) for highest frequencies. Unexcelled enclosure efficiency and superb speaker performance combine to cover the whole spectrum of audible sound for true hi-fi response from 35 to 15,000 cps,  $\pm 3$  db. Kit includes 12" 3-Way speaker, prefinished enclosure panels, grille cloth, hardware and instructions. Specify Korina blonde, mahogany or walnut when ordering. Shpg. wt., 44 lbs.

Model Y-937. 3-Way Speaker System Kit. Net only..... **\$89.50**

3-Way Speaker

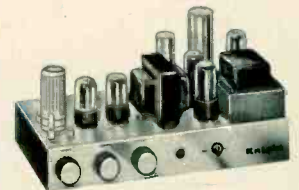

## knight-kit 10-Watt Hi-Fi Amplifier Kit

Y-753

**\$23<sup>50</sup>**

Low-cost, authentic hi-fi amplifier. Response,  $\pm 1$  db, 30-20,000 cps. Input for crystal phono or tuner; chrome-plated chassis is punched for preamp kit below, to permit use of magnetic phono. Only 0.5 volt drives amplifier to full output. Separate bass and treble controls. Only 1% harmonic distortion. Matches 8-ohm speaker. 7 x 13 x 6". With all parts, tubes and instructions. Shpg. wt., 13 lbs.

Model Y-753. Net only. **\$23.50**  
Y-235. Preamp Kit. **\$ 3.10**  
Y-757. Metal Cover. **\$ 3.95**

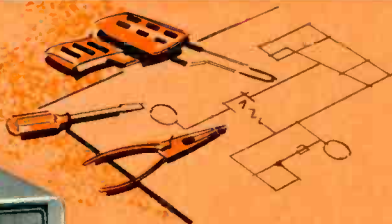

**So Easy To Build**  
Anyone can build  
KNIGHT-KIT HI-FI.  
No experience re-  
quired to get top  
results!



## knight-kit High Fidelity Preamp Kit

Model Y-754

**\$39.95**

Only \$3.99 down

- Exclusive Printed Circuit Switches and Boards
- Equalization  $\pm \frac{1}{2}$  db of Recommended Accuracy
- 8 Inputs Including Tape Head
- Self-Powered
- DC on All Tube Filaments
- Custom-Styled

Sensational Hi-Fi design at amazing low cost. Provides precise record equalization guaranteed within  $\frac{1}{2}$  db of recommended accuracy!—more accurate than all but the most expensive factory-built preamps. Includes exclusive new KNIGHT-KIT printed circuit switches for easy, error-free assembly; 2 printed circuit boards eliminate all other wiring, except for power supply and control leads—so easy to build. Has built-in power supply; includes premium 12AY7 and ECC82 tubes. Frequency response,  $\pm 0.5$  db, 10-50,000 cps. Has 8 inputs: Tape Head; G.E. Phono; Pickering Phono; Ceramic; Microphone; Auxiliary; Tape Preamp; Tuner. Level adjustment for tuner input. Includes separate Bass and Treble controls; separate Level and Loudness controls; Rumble Filter switch; DC on all tube filaments; cathode follower output; 2 extra AC outlets. You get every advanced hi-fi feature in this easy-to-build preamplifier at the lowest possible cost. Includes beautiful custom-styled French-gray case, with tapered chrome-finished legs, 4 x 13 x 8". With all parts, tubes, step-by-step instructions; ready for easy assembly. Shpg. wt., 12 $\frac{1}{2}$  lbs. **Model Y-754. Hi-Fi Preamp Kit. Net only. \$39.95**

## knight-kit 25-Watt Hi-Fi Basic Amplifier Kit

Model Y-755

**\$44.50**

Only \$4.45 down

- Hi-Fi Response,  $\pm 0.5$  db, 10 to 120,000 cps
- Only 0.15% Distortion at 30 Watts Output
- Printed Circuit Wiring Board • Chrome-Plated Chassis
- Williamson-Type Circuit with Over 25 Watts Output

Here's superb Hi-Fi performance at less than half the cost of a comparable commercially-assembled unit. Williamson-type linear-deluxe circuit delivers over 25 watts of virtually undistorted reproduction. Ideal for use with the KNIGHT-KIT preamp at left. Includes printed circuit board for simplified, error-free assembly. Remarkable hi-fi response,  $\pm 0.5$  db, 10-120,000 cps at 20 watts. Harmonic distortion, 0.15% at 30 watts; IM, 0.4% at 20 watts. Hum level, 85 db below 25 watts output. Output impedances, 4, 8 and 16 ohms; output tubes, 2-5881. Includes balance control for precise matching of the output tubes; variable damping control for maximum performance with any speaker system—prevents low-frequency distortion from overdamping or underdamping. Very attractive black and chrome styling, 6 $\frac{1}{4}$  x 14 x 9". An outstanding engineering achievement in a basic hi-fi amplifier, delivering performance equal to the finest commercially assembled units. Includes all parts and tubes; with step-by-step instructions, ready for easy assembly. Shpg wt., 25 lbs.

**Model Y-755. 25-Watt Amplifier Kit. Net only. \$44.50**  
**Y-759. Metal Cover for above; black finish. 5 lbs. Net. \$4.25**

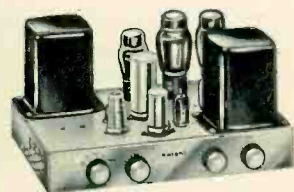

## knight-kit 20-Watt Hi-Fi Amplifier Kit

Y-750

**\$35.75**

\$3.57 down

True hi-fi for less! Complete with full set of controls and built-in preamplifier. Response,  $\pm 1$  db, 20-20,000 cps; distortion 1% at 20 watts. Inputs for magnetic phono, microphone, crystal phono or recorder, and tuner. Compensation positions for 78 and LP records. Separate bass and treble controls. Output impedances, 4, 8, 16 and 500 ohms. Chrome-plated chassis. 7 x 13 x 8 $\frac{3}{4}$ ". Ready for easy assembly. Shpg. wt., 20 lbs. **Model Y-750. Net only. \$35.75**  
**Y-758. Metal Cover. \$4.15**

## knight-kit 2-Way Hi-Fi Speaker System Kit

Model Y-789

**\$49.95**

Only \$4.99 down

- Easy to Assemble—Pre-Finished Enclosure
- High Fidelity Response, 45 to 14,000 cps
- 12" Woofer and Horn-Type Tweeter
- A Wonderful Money-Saving Speaker Value

**BIG SAVINGS**—assemble your own quality KNIGHT-KIT 2-way speaker system—it's quick and easy! The cabinet is *pre-finished* in full-grained, high luster blonde or mahogany—you just assemble 7 pieces, mount the speaker components and enjoy rich, thrilling hi-fi sound—at incomparably low cost. Special Jensen-engineered baffle features "ducted port" construction to bring out the full beauty of bass notes, perfectly matching the Jensen woofer and compression tweeter; genuine L-pad control is rear-mounted to permit adjustment of tweeter for best tonal balance. Impedance, 16 ohms. The assembled unit delivers a frequency response of 45 to 14,000 cps. Enclosure measures 26 x 19 x 14". Beautifully styled to blend in any room. Kit includes Jensen 12" woofer, Jensen compression-type tweeter, pre-finished wood parts (with grille cloth installed), acoustic material, glue, hardware and step-by-step instructions. Absolutely no furniture finishing required. *Specify blonde or mahogany finish when ordering.* Shpg. wt., 33 lbs.

**Model Y-789. 2-Way Speaker System Kit. Net only. \$49.95**



Fascinating

ALLIED **knight-kits**

FOR EXPERIMENTERS AND HOBBYISTS

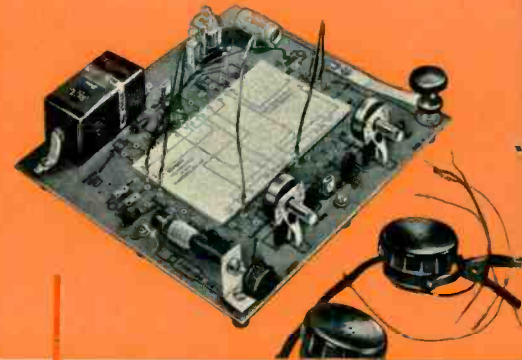

**knight-kit 2-Transistor Pocket Radio Receiver Kit**

- Model Y-262
- Loud, Clear Local Reception
  - Newest Printed Circuit Board
  - Built-In Loop Antenna
  - Complete Kit—Nothing Else To Buy

**\$14.65**

It's fun to build this pocket-size two-transistor radio—and you'll enjoy its crystal-clear local broadcast-band reception wherever you go! Fits in your pocket, or with its button-down flap, can be worn from your belt. Completely self-contained with built-in ferrite loopstick antenna—no external antenna needed. Extremely efficient reflex type 2-transistor circuit actually does the work of 3 transistors! Printed circuit board reduces building time to about one hour. Has air-dielectric variable capacitor for easy, accurate station tuning. Operates for months and months on long-life alkaline battery supplied. Sensitive miniature earpiece provides crystal-clear tone. Handsome tan carrying case, plastic-impregnated, is styled to resemble leather; only 4x3½x1¼". Kit includes all parts, transistors, earpiece, battery and case. Shpg. wt., 1½ lbs.

Model Y-262. Net only ..... **\$14.65**

**knight-kit "Trans-Midge" Transistor Receiver Kit**

- Model Y-767
- Tiny, cigarette-pack-size one-transistor radio kit—fascinating to build—so low-priced. This novel miniature receiver will provide endless listening

pleasures the moment assembly is completed. Covers the local AM broadcast band with exceptional sensitivity and selectivity. Special features include: Efficient, slug-tuned coil for excellent station separation; external knob for easy station tuning; low-drain transistor operating for months from single penlight cell supplied; hinged-back, red plastic case. Kit includes all parts, transistor, battery, compact case and easy-to-follow instructions for quick assembly. (External antenna and headphones required.) Shpg. wt., 8 oz.

Model Y-767. Net only ..... **\$2.45**  
 J-149. 4000 Ohm Headphones. 1 lb. .... **\$2.15**  
 C-100. Antenna Kit. 1½ lbs. .... **\$1.03**

**knight-kit 10-Circuit Transistor Lab Kit**

- Model Y-299
- Sensational experimenters' transistor kit—an electronic marvel! Perfect for experimenter, student or hobbyist.

Assemble basic parts once, then complete project after project (10 in all), by simply plugging leads into proper jacks on printed circuit board—no wiring changes needed. You learn how transistors operate by "plugging in" to make any one of the following circuits; AM radio for strong headphone reception; 2-stage audio amplifier; wireless broadcaster; code practice oscillator; electronic timer; electronic switch; electronic flasher; photoelectronic relay; voice-operated relay; capacity-operated relay. Includes all parts, 2 transistors, battery, headphones, circuit leads, relay, photocell, special guide cards for each project, explanation of each circuit. 3 lbs.

Model Y-299. Net only ..... **\$15.75**

**knight-kit 5-Transistor Superhet Personal Portable Radio Kit**

- Model Y-766
- Styled to Equal the Finest
  - Push-Pull Audio Drives 3½" Speaker
  - Printed Circuit for Easy Building
  - 200 Hour Battery Playing Life

**\$29.95**

Beautiful, easy-to-build transistorized personal portable with every ultra-modern design feature: 5 Texas Instrument Co. transistors; latest printed circuit chassis for easy, error-free assembly; bigger-than-average 3½" speaker; class B push-pull audio output; built-in high-gain ferrite loopstick antenna; plus phone jack output for private listening. Provides sensitive reception of the AM broadcast band with exceptional tone quality. Ultra-smart high-impact ivory plastic case has handsome gold trim with ebony accents; includes pull-out handle; only 7½x3¾x1¼". With all parts, transistors, 9 volt transistor radio battery, carrying case and instructions anyone can easily follow. Shpg. wt., 2 lbs.

Model Y-766. Net only ..... **\$29.95**

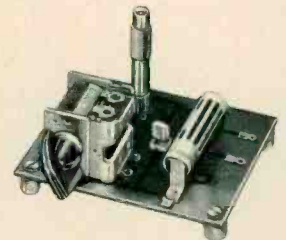

**1-Transistor Radio Kit**

- \$3.95** Offers excellent AM local broadcast headphone reception. Printed circuit board for easy assembly. Operates from single penlight cell for months. Complete with all parts, transistor and penlight cell. (Antenna and headphones required.) Shpg. wt., 1 lb.  
 Model Y-765. Net only ..... **\$3.95**



**"10-In-One" Electronic Lab Kit**

- \$12.65** Famous experimenters' kit. Builds any of 10 fascinating projects, including broadcast receiver, wireless phono oscillator, code practice oscillator, signal tracer, relays, etc. Shpg. wt., 5 lbs.  
 Model Y-265. Net only ..... **\$12.65**



**"6-In-One" Electronic Lab Kit**

- \$8.45** A favorite with beginners. After basic wiring is completed, you make circuit changes without soldering. Builds any of six favorite projects, including radio, wireless broadcaster, etc. Shpg. wt., 3 lbs.  
 Model Y-770. Net only ..... **\$8.45**



**Crystal Set Hobby Kit**

- \$2.15** Entertaining, educational. Delivers clear headphone reception of local broadcast stations. With all parts, ready for easy assembly. (Antenna and headphones required.) Shpg. wt., 1 lb.  
 Model Y-261. Net only ..... **\$2.15**



**Wireless Broadcaster Kit**

- \$9.50** Play music or make announcements through your radio set—no connection to set required! Loads of fun—easy to build. Works up to 50 feet from set. Shpg. wt., 3 lbs.  
 Model Y-705. Net only ..... **\$9.50**

ORDER FROM **ALLIED RADIO** 100 N. WESTERN AVE. • CHICAGO 80, ILL.



**FUN TO BUILD . . . INSTRUCTIVE . . . LATEST CIRCUITS FOR TOP PERFORMANCE  
WIDEST CHOICE OF QUALITY HOBBYIST KITS**



Interruption of light beam triggers relay, which in turn sounds chime or bell, turns on lights, etc.

**knight-kit Photoelectric Relay Kit**

**Model Y-702** Advanced-design, ultra-sensitive photoelectric relay—build it yourself and save! Dozens of uses: for automatic control of lights, door announcer, burglar alarm, counting devices, etc. Provides dependable operation up to 250 feet with white light, up to 125 feet with "unseen" light (red filter) from Light Source Kit listed below. Selectable operator, with "trip" for burglar alarm to provide continuous ringing of alarm; and "auto" if relay is to operate each time beam is broken (for chimes, counting devices, turning on lights at darkness). Has SPST relay operated from thyatron; 6.3 v. terminals provide power for accessories. For 105-120 v., 50-60 cy. AC use. 6 lbs.  
**Model Y-702.** Relay Kit. Net only. \$13.50  
**Model Y-703.** Light Source Kit. With bulb and red filter. Shpg. wt., 3½ lbs. Net. \$6.75

**\$13.50**



**knight-kit "Ocean Hopper" All-Wave Radio Kit**

**Model Y-740** This top-performing regenerative receiver puts a world of listening pleasure at your finger-tips. Tuning range (using coils listed below) is virtually world-wide: covers 155 kc to 35 mc. including every type of radio transmission: AM broadcast, marine, aircraft, distress channels, direction-finding, Amateur, frequency standard, foreign broadcast, and police. With bandspread tuning. For use with headphones or 3-4 ohm PM speaker. Kit is supplied with standard broadcast band coil and all tubes and parts. (Less extra coils, headphones, speaker and cabinet.) Shpg. wt., 5 lbs.  
**Model Y-740.** Net only. \$11.95  
**Y-746.** Cabinet for above. 1½ lbs. Net \$2.90  
Extra coils available: Long Wave Coil (155-470 kc). Net 79c. Short Wave (1.65—4.1 mc; 2.9—7.3 mc; 7—17.5 mc and 15.5—35 mc). Each 65c.

**\$11.95**



**knight-kit "Space-Spanner" Bandswitching World-Wide Radio Kit**

**Model Y-243** • Broadcast or Short Wave Reception  
• Sensitive Regenerative Circuit  
• Convenient Bandspread Tuning  
• Built-In Loudspeaker  
Imagine the thrill of hearing overseas broadcasts on a precision receiver you've built yourself—and then, at the flip of a switch, being able to tune to your favorite local broadcast station! Bandswitch selects exciting short wave, including foreign broadcasts, amateur calls, aircraft, police and marine radio on the 6.5 to 17 mc range, as well as standard 540-1700 kc broadcasts. Features highly sensitive regenerative circuit. Includes built-in 4" PM speaker and beam-power tube for strong volume and clear tone. Headphone connectors are available for private listening; switch cuts out speaker. Controls: Bandspread, Main Tuning, Antenna Trimmer, Bandswitch, Regeneration, Volume. 7x10x6". Easy to build from step-by-step instruction manual. For 110-120 v., 50-60 cy. AC or DC. (Less cabinet.) Shpg. wt., 5 lbs.  
**Model Y-243.** Net only. \$15.95  
**Y-247.** Cabinet for above. Shpg. wt. 2 lbs. Net \$2.90

**\$15.95**



**"Ranger II" Superhet Receiver Kit**

**\$17.25** Popular Broadcast band receiver built and enjoyed by thousands. Features built-in antenna automatic volume control, ball-bearing tuning condenser, PM dynamic speaker. Handsome plastic cabinet. Easy to assemble. AC or DC operation. Shpg. wt., 8 lbs.  
**Model Y-735.** Net only. \$17.25

**knight-kit 2-Way Intercom System Kit**

**Model Y-295** • Low Cost—Easy to Assemble  
• High Gain—Clear Tone  
• Handsome Metal Cabinets  
• Includes 50-Foot Cable

**\$14.75** Easy to build at lowest cost—ideal for home, office, shop or school. Consists of Master unit and Remote unit. Remote unit may be left "open" for answering calls from a distance, for "baby sitting", etc. Remote also may be set for "private" operation—cannot be "listened-in" on, but it can be called and can originate calls. Master unit includes high-gain 2-stage amplifier, combination volume control and on-off switch, plus pilot light. Each unit has 4" PM dynamic speaker. System responds to even a whisper. Handsome Antique white cabinets, each 4¾x6½x4¾". With all parts, tubes and 50-ft. cable (up to 200-ft. may be added). For 110-120 v., AC or DC. 8 lbs.  
**Model Y-295.** Master and one Remote. Net only. \$14.75  
**Y-296.** Extra Remote Station Kit. 3 lbs. \$3.75

**\$14.75**

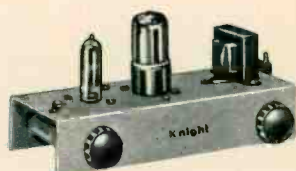

**Phono Amplifier Kit**

**\$9.45** Build it yourself—and save! Ideal for use in a portable phonograph—just add record player and 3-4 ohm speaker. 1½ watts output. Inverse feedback circuit. Easy to assemble. Shpg. wt., 3 lbs.  
**Model Y-790.** Net only. \$9.45

**\$9.45**



**Electronic Photoflash Kit**

**\$28.50** Ideal for color or black and white photography. 1/700th-of-a-second flash; 50 watt/second output. Synchronizes with any camera with X or O shutter. (Less battery.) Shpg. wt., 4 lbs.  
**Model Y-244.** Net only. \$28.50

**\$28.50**



**Code Practice Oscillator Kit**

**\$3.95** Ideal for beginners learning the code. Transistorized circuit. Operates for months from single penlight cell supplied. Clear, crisp 500 cycle tone. Jacks for headphones; screw terminals for key. 1 lb.  
**Model Y-239.** Net only. \$3.95

**\$3.95**



**Phono Oscillator Kit**

**\$5.85** "Broadcasts" recorded music through any standard radio set up to 50 feet away. No direct connection to set required. Easy to build—fun to use. Shpg. wt., 2 lbs.  
**Model Y-760.** Net only. \$5.85

**\$5.85**



**knight-kit Low-Cost Tube Tester Kit**

- Model Y-143
- With 16 Filament Voltages
  - 600 Latest Tube Types Listed
  - Easy-to-Read 4½" Meter
  - Tests Series-String TV Tubes

**\$29<sup>75</sup>**

Expertly designed for complete, up-to-date coverage of tube types. Tests *series-string TV tubes*; tests 4, 5, 6 and 7 pin large, regular and miniature types, octals, loctals, 9-pin miniatures and pilot lamps. Tests for open, short, leakage, heater continuity and performance (by amount of cathode emission). Big 4½" square meter has clear "GOOD-?-REPLACE" scale. With line-voltage indicator and line-adjust control. Choice of 16 filament voltages from 0.63 to 117 volts to check virtually all receiving tubes; blank socket for future type tubes. Universal-type selector switches permit selection of any combination of pin connections. Single-unit, pre-assembled 10-lever function switch simplifies and speeds assembly. Up-to-date illuminated roll chart lists over 600 tube types. Counter model case, 5 x 14 x 10". Easy to build. 14 lbs.

- Model Y-143. Net only ..... **\$29.75**  
 Y-142. Portable Case model. 15 lbs. Net ..... **\$34.75**  
 Y-141. Picture Tube Adapter. 1 lb. Net ..... **\$ 4.25**

**knight-kit RF Signal Generator Kit**

- Model Y-145
- Build this wide-range, extremely stable RF signal generator—save two-thirds the cost of a comparable wired instrument!
  - Large, semi-circular dial is clearly calibrated; range is covered in 5 separate bands for close accuracy in setting individual frequencies. Ideal for aligning RF and IF stages in radio and TV sets and for troubleshooting audio equipment. Delivers output on fundamentals from 160 kc all the way out to 112 mc; useful harmonics to 224 mc. Has built-in 400-cycle sine-wave audio oscillator for modulating RF; audio is also available externally. Features high-stability Colpitts circuit. Convenient jack for external modulation. Maximum audio output 10 volts; RF output over 0.1 volt on all ranges. Step and continuous-type attenuator controls. Supplied with precision-wound coils that require no adjustment.
- 7 x 10 x 5". Shpg. wt., 11 lbs.

**\$19<sup>75</sup>**

Model Y-145. Net only ..... **\$19.75**

**knight-kit 1000 Ohms/Volt VOM Kit**

- Model Y-128
- Exceptional accuracy and versatility at amazing low cost. Ideal for service shop, lab or Amateur use. Large 4½", 400 microamp meter with separate scales for AC and DC voltage and current, decibels and resistance. Uses 1% precision resistors; has 3-position function switch and 12-position range switch. 38 ranges include: AC, DC and output volts, 0-1-5-10-50-500-1000 ohms/volt sensitivity; Resistance, 0-1000-100,000 ohms and 0-1 meg (center scale readings of 60, 150 and 1500 ohms); Current, AC or DC, 0-1-10-100 ma and 0-1 amp; Decibels, -20 to +69 in 6 ranges. Precision resistors are used as shunts and multipliers to assure exceptional accuracy of measurements. With all parts, battery, test leads and black bakelite case with convenient carrying handle, 6¾ x 5½ x 3¾". A great value in an easy-to-build quality instrument. Shpg. wt., 2½ lbs.

**\$16<sup>95</sup>**

Model Y-128. Net only ..... **\$16.95**



**knight-kit Vacuum Tube Voltmeter Kit**

- Model Y-125
- 200 µa Movement, 4½" Meter
  - Includes AC, Peak-to-Peak
  - Balanced-Bridge, Push-Pull Circuit
  - 1% Film-Type Resistors

**\$24<sup>95</sup>**

Top buy in an extremely stable, highly accurate VTVM. Easy to assemble—entire chassis is printed circuit board. Perfect for radio-TV service work, lab and Amateur use. Features low-leakage type switches; 1% film-type precision resistors; balanced-bridge, push-pull circuit (switch to any range without readjusting zero set); zero center scale and direct-reading db scale; polarity reversing switch. Ranges: Input Resistance, 11 megohms; DC and AC rms, 0-1-5-5-15-50-150-500-1500; AC Peak-to-Peak, 0-4-14-40-140-1400-4000; Response, 30 cycles to 3 mc; Ohms, 0-1000-10K-100K and 0-1-10-100-1000 megohms; db, -10 to +5. Includes all parts, tubes, battery, test leads and portable case, 7¾ x 5½ x 4-¾". Easy to assemble. Shpg. wt., 6 lbs.

- Model Y-125. Net only ..... **\$24.95**  
 Y-126. Hi Voltage Probe; extends DC to 50,000 v. .... **\$ 4.75**  
 Y-127. Hi-Frequency Probe; extends AC to 250 mc. .... **\$ 3.45**



**6V-12V Battery Eliminator Kit**

- Model Y-129
- High current rating; continuously variable filtered output; delivers 15 amps at 6 volts, 10 amps at 12 volts. May be used as battery charger. Two meters provide simultaneous current and voltage readings. Shpg. wt., 18 lbs.

**\$32<sup>95</sup>**

Model Y-129. Net only ..... **\$32.95**



**Transistor Checker Kit**

- Model Y-149
- Checks gain ratio of all types of transistors; checks germanium and silicon diodes; checks for continuity and shorts. A valuable instrument at very low cost. Easy to assemble. Shpg. wt., 2½ lbs.

**\$8<sup>50</sup>**

Model Y-149. Net only ..... **\$8.50**



**Flyback Checker Kit**

- Model Y-118
- Checks condition of all types of horizontal output transformers and deflection yokes, as well as TV linearity and width coils. 4½" meter; widest range in its field. Shpg. wt., 6 lbs.

**\$19<sup>50</sup>**

Model Y-118. Net only ..... **\$19.50**



**Sweep Generator Kit**

- Model Y-123
- Extreme linearity on a par with costly lab instruments; fundamentals to 250 mc; output flat within 1 db; electronic blanking. Easy, money-saving assembly. Shpg. wt., 16 lbs.

**\$43<sup>75</sup>**

Model Y-123. Net only ..... **\$43.75**



**Capacitor Checker Kit**

- Model Y-119
- Tests capacitors while in the circuit! Has widest range—20 mmf to 2000 mfd. Exclusive circuit for cancelling lead capacity. "Magic Eye" indicator. Save 60% over factory-wired units. 5 lbs.

**\$12<sup>50</sup>**

Model Y-119. Net only ..... **\$12.50**

ADVANCED-DESIGN INSTRUMENTS FOR SERVICE, INDUSTRIAL AND RESEARCH USE  
IN EASIEST-TO-BUILD, MONEY-SAVING KIT FORM



**knight-kit 20,000 Ohms/Volt VOM Kit**

**Model Y-140** Outstanding quality and performance at money-saving low price. Features 1% precision multipliers; 4½" meter accurate within 2% of full scale deflection; 50 microamp sensitivity for 20,000 ohms/volt input resistance on DC; front panel "Zero adjust"; single switch to select function and range. 32 ranges: AC, DC and output volts, 0-2.5-10-50-250-1000-5000; Resistance, 0-2000-200,000 ohms and 0-20 meg.; DC ma, 0-0.1-10-100; DC amps, 0-1-10; Decibels, -30 to +63 in six ranges. Moisture-resistant film-type resistors for extreme accuracy. Carefully engineered circuit design achieves high sensitivity and extremely versatile application. Kit includes all parts, battery, test leads and black bakelite case with highly legible white markings; size 6¾ x 5¼ x 3¾". Easy to assemble. Shpg. wt., 5 lbs.

**Model Y-140.** Net only ..... \$29.50



**knight-kit High-Gain Signal Tracer Kit**

**Model Y-135** A remarkable value in an easy-to-build instrument which permits visual and aural signal tracing of RF, IF, video and audio circuits. Has highest gain in its price class. Traces signal from antenna to speaker. Reproduces signal at plate or grid connection of any stage. Identifies and isolates "dead" stages. Features: usable gain of 91,000; "magic eye" with calibrated attenuators for signal presence indication and stage-by-stage gain measurements; built-in 4" PM speaker; combination 2-position probe, one for RF (6 mmf. input), the other for audio. Provides noise test; built-in watt-meter calibrated from 25 to 1000 watts; provision for external scope or VTVM. Binding posts provide output transformer and speaker substitution test, plus external 280 volts B+. With all parts, tubes and probe. 7x10x5". 12 lbs.

**Model Y-135.** Net only ..... \$26.50

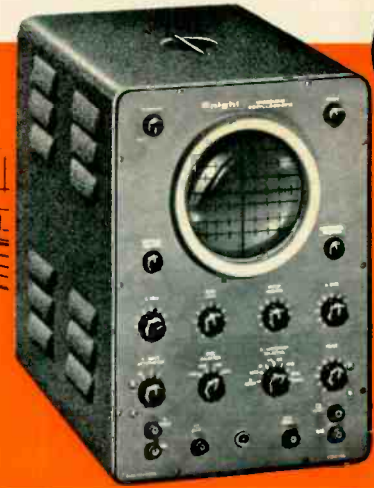

**knight-kit 5" Wide-Band Oscilloscope Kit**

- Model Y-144**
- 5 mc Width for Color TV
  - Horizontal Sweep to 600 kc
  - 25 mv/inch Sensitivity
  - Z-Axis Input
  - Printed Circuit Construction

Only \$6.90 down  
**\$69.00**  
Equals or betters the performance of commercially wired scopes costing far more. Two printed circuit boards and laced wiring harness assure wiring accuracy and cut assembly time. Ideal for lab use, color TV servicing and high frequency applications. Wide sweep range—15 to 600,000 cps. Vertical response, ± 3 db, 5 cps to 5 mc; only 1 db down at 3.58 mc color burst. High vertical sensitivity of .025 rms v/inch. Input capacity, 20 mmf. Outstanding features: cathode follower inputs; 2nd anode provides 1400 volts high-intensity trace; push-pull amplifiers; positive and negative locking; frequency-compensated attenuator; Z-axis input; one volt P-P calibrating voltage; astigmatism control; retrace blanking circuit; DC positioning control. Includes CRT. 14½ x 9½ x 16". 40 lbs.

**Model Y-144.** Net only ..... \$69.00  
**Y-148.** Demodulator Probe. Net ..... \$ 3.45  
**Y-147.** Low Capacity Probe. 12 mmf. Net ..... \$ 3.45



**Voltage Calibrator Kit**

**\$12.75** Permits use of any scope as precision peak-to-peak AC voltmeter. Puts a true square-wave voltage on scope screen. Selects any voltage between .01 and 100 volts; feeds external signal direct to scope for instant comparison. Shpg. wt., 5 lbs.

**Model Y-136.** Net only ..... \$12.75

**knight-kit 5" General-Purpose Scope Kit**

- Model Y-146**
- Phantastron Linear Sweep
  - 25 mv/inch Sensitivity
  - Printed Circuit Board
  - Retrace Blanking Circuit

**\$42.00**

Only \$4.20 down

Feature for feature the world's best oscilloscope kit value. A stand-out in its class with all these fine features: *Printed Circuit* wiring board and laced harness for quick, error-free assembly. *Phantastron Sweep Circuit* for high linearity of sweep from 15 to 150,000 cps. *25 Millivolts Per Inch Sensitivity*—3 times that of similarly priced scope kits. *Calibration Voltage*—1 volt peak-to-peak square wave, fully regulated. *Vertical Amplifier*—frequency response ± 3 db, 3 cps to 1.5 mc (± 6 db to 2.5 mc). Includes: Directly coupled positioning controls; retrace blanking circuit; frequency-compensated vertical input attenuator; positive and negative internal sync; high 2nd-anode voltage for high-intensity trace; input capacity, 45 mmf. Kit includes CRT. 9½ x 13¾ x 17¾". 26 lbs.

**Model Y-146.** Net only ..... \$42.00



**Resistance Substitution Box**

**\$5.95**

Easily determines resistor values required in a circuit. Makes available 36 standard 1-watt resistance values in 2 ranges between 15 ohms and 10 megohms, with 10% accuracy. Slide switch selects range; 18-position switch for value selection. Shpg. wt., 2 lbs.

**Model Y-139.** Net only ..... \$ 5.95



**Capacitance Substitution Box**

**\$5.95**

Makes it easy to find capacitor values needed in a circuit. Provides 18 standard values from .0001 mfd to .22 mfd, ± 20%. All values are 600 volt, except .15 and .22, which are 400 volt. 18-position selector switch. Shpg. wt., 2 lbs.

**Model Y-138.** Net only ..... \$ 5.95



**Audio Generator Kit**

**\$31.50**

Excellent design; range, 20 cps to 1 mc; less than .25% distortion; 600 ohm output. Ideal for hi-fi testing; offers the flat response of a lab standard. Shpg. wt., 16 lbs.

**Model Y-137.** Net only ..... \$31.50



**R/C Tester Kit**

**\$19.50**

Measures capacitance and resistance. Balanced-bridge circuit; indicates power factor; tests capacitors at rated voltage. Large, easy-to-read dial and "magic eye." Shpg. wt., 10 lbs.

**Model Y-124.** Net only ..... \$19.50

**EASY TERMS AVAILABLE**

Take advantage of the most liberal Easy Pay plan in electronics. On Knight-Kit orders totaling \$45 or more—just 10% down, small monthly payments thereafter. Low carrying charges—no "red tape."



# knight-kits FOR THE RADIO AMATEUR

## knight-kit 50-Watt CW Transmitter Kit



Model Y-255

**\$38.95**

Only \$3.89 down

- Ideal for the Novice
- Pi Antenna Coupler
- Bandswitching—80 to 10 Meters

There's exceptional value in this very popular bandswitching transmitter kit. Compact and versatile, it's the perfect low-power rig for the beginning novice as well as the seasoned veteran. Has bandswitching coverage of 80, 40, 20,

15 and 10 meters. Rated at 50 watts—actually operates at up to 60 watts on 80 and 40 meters. Oscillator is efficient 6AG7; final is reliable 807. Crisp, clean, cathode keying of oscillator and final. Built-in pi coupler permits use with random length antennas. Has highly effective TVI suppression. Other features not usually found in transmitter kits at this low price include: Ceramic-insulated final tank capacitor; pre-assembled switches; pre-wound parasitic chokes; ceramic coil forms; coax connector; crystal and VFO socket on front panel; power take-off jack for accessory equipment. Meter reads either plate or grid current of final. Takes crystal or VFO without circuit changes. Cabinet interior and chassis are copper-finished. Size, 8½ x 10½ x 8¼". With tubes and all parts for easy assembly. (Less crystal and key.) Shpg. wt., 19 lbs.

Model Y-255. 50-Watt Transmitter Kit. Net only..... **\$38.95**

## knight-kit All-Band Amateur Receiver Kit

Model Y-726

**\$104.50**

Only \$10.45 down

- Tunes 540 kc to 31 mc
- Built-In Q-Multiplier
- Constant Running HF Oscillator
- Worthy of the Advanced Ham Operator
- Printed Circuit Bandswitch
- Printed Circuit Board • 1.5 μv Sensitivity

A sensational communications receiver value with all the selectivity, sensitivity and features of high-priced commercial units. Uses printed circuitry throughout, including the exclusive new KNIGHT-KIT printed circuit bandswitch, for remarkably easy assembly. Covers 540 kc to 31 mc in 4 ranges; calibrated, electrical bandspread on 80-10 meter Ham bands; slug-tuned Hi-Q coils; continuous, VR tube-regulated B+ applied to HF oscillator lets you switch from standby to receive with no drift; built-in Q-multiplier peaks desired signal or nulls interference; delayed AVC; provision for crystal calibrator (below). Sensitivity, 1.5 microvolts for 10 db signal-to-noise ratio. Selectivity: variable from 300 cps to 4.5 kc at 6 db down. Exalted BFO injection. Controls: Main tuning, bandspread, band selector, Q-multiplier selectivity, Q-multiplier tune, null-off-peak, BFO pitch, RF gain, AF gain, BFO-MVC-AVC-ANL, off-stby-rec-cal, antenna trimmer, and phone jack. Cold-rolled ¼" steel chassis. Handsome metal cabinet, 10 x 10 x 16½". (Less phones, 8-ohm loudspeaker and S-meter.) 23 lbs.

Model Y-726. Amateur Receiver Kit. Net..... **\$104.50**

Y-727. S-Meter Kit for above. 1 lb. Net..... **\$9.50**

## knight-kit Self-Powered VFO Kit



Model Y-725

**\$28.50**

Only \$2.85 down

Complete with built-in power supply! Careful design and voltage regulation assure high stability. Excellent oscillator keying characteristics for fast break-in without clicks or chirps. Full TVI suppression. Has plenty of bandspread; separate calibrated scales for 80, 40, 20, 15, 11 and 10 meters; vernier drive mechanism. 2-chassis construction keeps heat from frequency determining circuits. Output cable plugs into crystal socket of transmitter. Output: 40v on 80, 20v on 40. With Spot-Off-Transmit switch for spot frequency tuning. Extra switch contacts for operating relays and other equipment. Attractive metal cabinet, 8¾ x 6 x 6". Ready for easy assembly. Shpg. wt., 8 lbs.

Model Y-725. VFO Kit. Net only..... **\$28.50**

## knight-kit 100 Kc Crystal Calibrator Kit

Model Y-256

**\$10.50**

Crystal frequency standard at very low cost. Gives marker every 100 kc up to 32 mc. A "must" for marking band edges. Mounting flanges for installation in or back of receiver cabinet. Size only 1½ x 1½ x 3". Requires 6.3 v. at 0.15 amp and 150-300 v. DC at 3-6 ma. Trimmer for zero-beating with WWV; On-Off switch. Complete with tube, crystal, all parts and easy-to-follow instructions. Shpg. wt., 1 lb.

Model Y-256. 100 Kc Crystal Calibrator Kit. Net only..... **\$10.50**



## knight-kit Amateur RF "Z" Bridge Kit



Model Y-253

**\$5.85**

Measures standing wave ratio (SWR) and impedance-of antenna systems; ideal for adjusting antenna systems for optimum results. Measures impedances from 20 to 400 ohms up to 100 mc; SWR to 150 mc. Any VOM may be used for null indicator. With coax input and output connectors. Meters both input and bridge voltage. Calibrated dial gives direct impedance reading; includes 1% precision resistor for precise calibration adjustment. With all parts and handy plasticized SWR chart (less meter). 2½ x 3 x 4½". Shpg. wt., 1½ lbs.

Model Y-253. "Z" Bridge Kit. Net only..... **\$5.85**

**ORDER BLANK**

**ALLIED RADIO**

100 N. WESTERN AVE., CHICAGO 80, ILL.

ALLIED RADIO, Dept. PF, 100 N. Western Ave., Chicago 80, Ill.

Ship me the following KNIGHT-KITS:

Quantity	Description	Model No.	Price

\$..... enclosed. (For parcel post, include postage—express is shipped collect).

My Down Payment in the amount of \$..... is enclosed. Send Time Payment form.

Name.....

Address.....

City..... Zone..... State.....

ALL PRICES NET F. O. B. CHICAGO



*Our 37th Year*



**FREE 1958**  
**404-PAGE**  
**ALLIED**  
**CATALOG**

See the 1958 ALLIED 404-Page Catalog for complete listings of

more than 50 KNIGHT-KITS, covering Hi-Fi, Hobby, Test Instrument and Amateur Kits. The 1958 ALLIED Catalog is your complete Buying Guide to the world's largest stocks of everything in Electronics.

Send FREE 404-Page 1958 ALLIED Catalog.

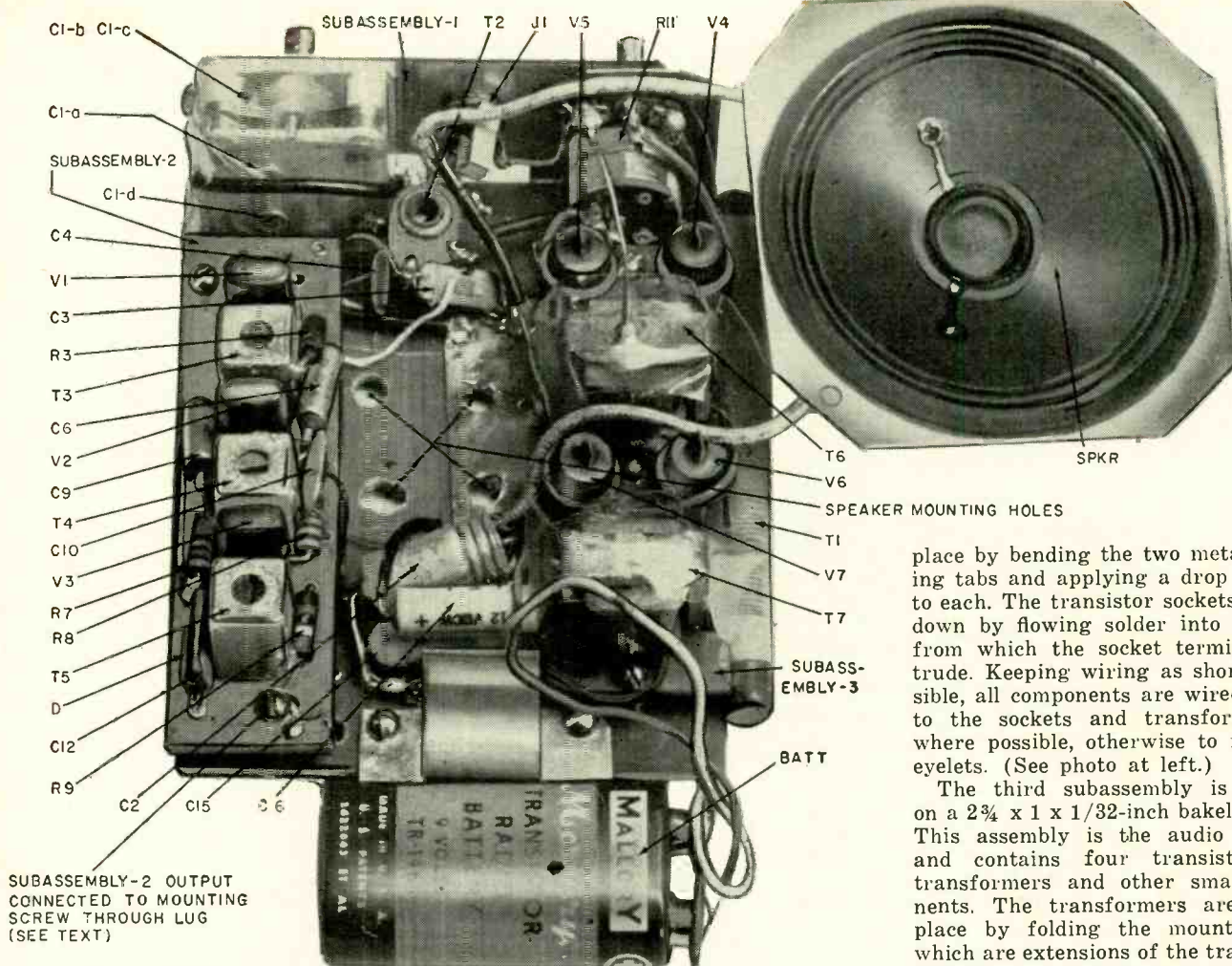

SUBASSEMBLY-2 OUTPUT CONNECTED TO MOUNTING SCREW THROUGH LUG (SEE TEXT)

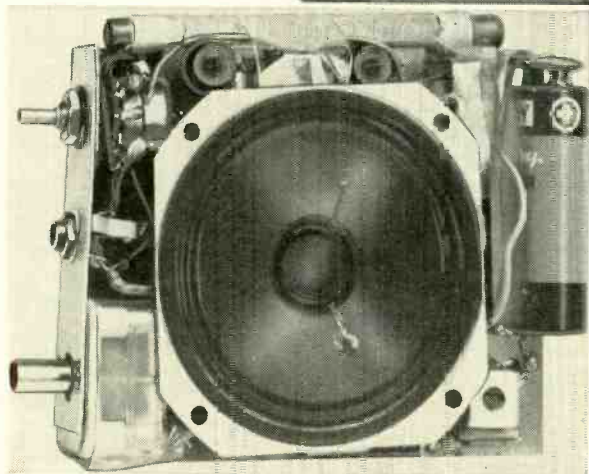

(Above) The receiver's chassis before the speaker is mounted.

(Left) Chassis view with speaker properly mounted.

(Continued from page 84)  
 second detector. The audio section contains four 2N107 transistors. One of ampl, one driver and two utilized in a transformer-coupled class-B push-pull power stage. Power is obtained from a 9-volt mercury battery.

**Construction details**

The receiver consists of a main chassis assembly, containing three sub-assemblies plus the antenna and oscillator coils, battery clip and loudspeaker. The first of the three sub-assemblies is a 1/32-inch-thick aluminum bracket which supports tuning capacitor, phone

jack and volume control. Fig. 2-a  
 The second subassembly is mounted on a bakelite chassis 3/4 x 7/8 x 1/32 inch and contains the converter, if amplifier and second detector stages. To mount transistor sockets and if transformers locate each part in its permanent place on the blank bakelite chassis and with a sharp tool mark the spot where the terminal of each part touches the chassis. After removing the sockets and transformers, 3/32-inch holes are drilled. Each part is placed in its proper location and its terminals are pushed through the holes.  
 The if transformers are secured in

place by bending the two metal mounting tabs and applying a drop of solder to each. The transistor sockets are held down by flowing solder into the holes from which the socket terminals protrude. Keeping wiring as short as possible, all components are wired directly to the sockets and transformer lugs where possible, otherwise to miniature eyelets. (See photo at left.)

The third subassembly is mounted on a 2 3/4 x 1 x 1/32-inch bakelite board. This assembly is the audio amplifier and contains four transistors, two transformers and other small components. The transformers are held in place by folding the mounting tabs, which are extensions of the transformer cover, under the chassis. Copper straps wrapped around the transformer add security and make good ground points (see Fig. 2-b). I found it convenient to slot the chassis so the tabs would fit into them and prevent the transformers from sliding around. As before, all small parts are wired directly between the major components or tied to eyelets.

On the main chassis a 3/16-inch mounting hole is drilled a bit to the right and rear of where the tuning capacitor will be located. The oscillator coil is inserted in this hole and cemented in place.

The first and second subassemblies are then set in place on the main chassis. Subassembly 1 (bracket supporting the tuning capacitor, phone jack and volume control) is secured as shown in the photo. Then assembly No. 2 is mounted on the left side of the main chassis just behind the tuning capacitor and held in place by two No. 4-40 screws. Two 3/16-inch spacers are used for support.

The output from the second detector on subassembly 2 is connected to a lug through which the rear mounting screw passes and is picked up by another lug on top of which the nut is tightened on the under side of the main chassis. A connecting wire is run from this lug (left rear corner) to an eyelet in the front right corner and then up to the volume control. Next make all

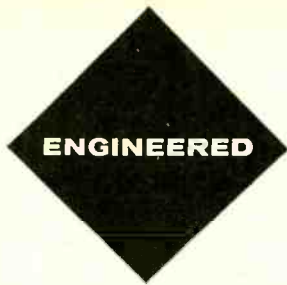

to  
be  
listened  
to

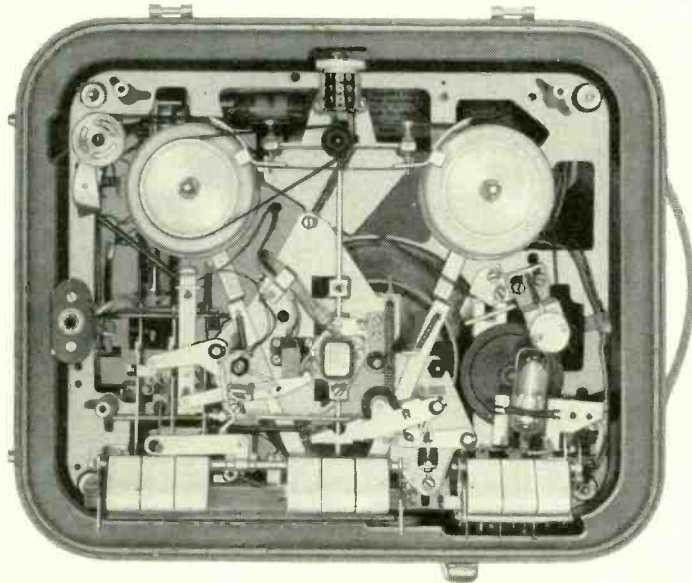

introducing the

# NORELCO® 'CONTINENTAL'

three-speed portable

## TAPE RECORDER

Above is a technician's-eye view of the new Norelco 'Continental.' It is a reassuring picture to tape recorder mechanics—many are even calling the 'Continental' the most advanced machine of its type. But most of the readers of this magazine are not tape recorder mechanics—they are seekers of good sound. It is to these readers that we say—the specifications of the 'Continental' are great...but that's beside the point! We won't tell you about them yet—because we first want you to listen to the sound! Go to your dealer and ask for a demonstration. Then just listen. The Norelco 'Continental' will convince you with sound—not with cycles and decibels. Don't say we didn't tell you in time for Christmas!



Engineered by Philips of the Netherlands, world pioneers in electronic design

Precision-crafted by Dutch master technicians

Styled by the Continent's top designers  
Three speeds (7½, 3¾ and 1½ ips)...  
twin tracks...pushbutton controlled

Special narrow-gap (0.0002 in.)  
magnetic head for extended  
frequency response

Built-in wide-range Norelco speaker

Lightweight...easily portable...rugged

Can also be played through external  
hi-fi system



For the name  
and address  
of your nearest  
Norelco dealer,  
write to Dept. 64

NORTH AMERICAN  
PHILIPS CO., INC.  
High Fidelity  
Products Division  
230 DUFFY AVENUE,  
HICKSVILLE, L. I., N. Y.

### RADIO

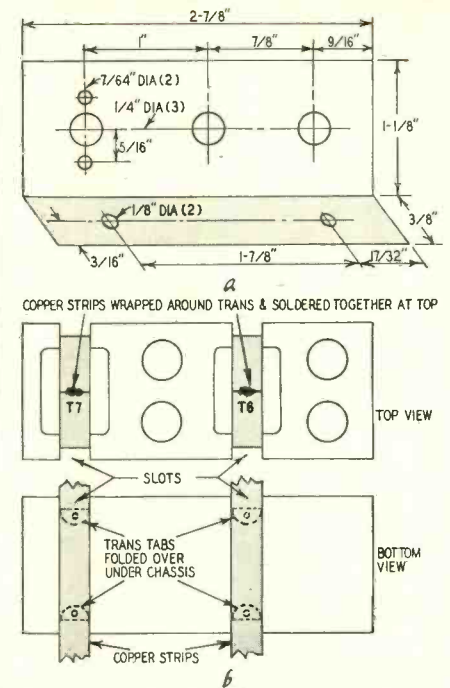

Fig. 2—*a*—Bracket to support tuning capacitor, phone jack and volume control; *b*—securing the audio transformers.

other connections between the main chassis and subassemblies 1 and 2.

#### Alignment procedure

At this point power is applied and all alignment adjustments made. A signal generator is connected between the antenna terminal of the tuning capacitor and ground. The generator settings are modulation, 400 cycles—30%; frequency, 455 kc; output, 15  $\mu$ v. An ac vtvm is connected between the center terminal of the volume control and ground. With the control on full and the meter set to the .03-volt range, T5 is tuned for a maximum indication on the vtvm. T4 is then tuned to resonance. This is repeated with T3. Then repeat the whole procedure.

Upon completing the alignment of the if stages, the signal generator and radio dial are tuned to 1550 kc (connections between signal generator and radio remain unchanged). The trimmer of the oscillator section of the tuning capacitor is adjusted for maximum response. Next the generator and radio dial are set to 600 kc. The slug in the oscillator is now adjusted for maximum response. This whole procedure is repeated. The final adjustment consists of tuning the signal generator and radio dial back to 1550 kc and adjusting the trimmer of the tuning capacitor's rf section for maximum response. Correct operation of the receiver is indicated by a reading of .012 volt on the vtvm, when the radio and signal generator are tuned to 1000 kc.

When alignment is completed, power is removed and the loudspeaker prepared for mounting. I used a Lafayette SK-65. It is not equipped with mounting holes in the rear frame. Four holes, therefore, have to be drilled and tapped for 6-32 machine screws.

## RADIO

The holes must clear the magnet pole piece and side walls of the magnet housing. When drilling these holes, take care and don't get any metal filings between the voice coil and magnetic pole piece. I used cellophane tape to protect against this.

After the holes are drilled, the speaker with its voice coil terminals facing to the rear, is set in place in the center of the main chassis and as close to subassembly No. 2 as possible. With a scribe or some other sharp tool, the outline of the rear of the speaker in its permanent position on the main chassis is scratched. Next the speaker mounting holes are marked off. The speaker is removed and mounting holes are drilled in the main chassis. With the speaker fastened in place, subassembly 3 is mounted. This unit fits on the left side of the main chassis, directly behind the volume control, as shown in the photos. The mounting holes for this assembly are marked off next and drilled in all members. The amplifier strip is screwed in position, supported by two 3/16-inch spacers.

The battery clip is a standard holder for a Burgess Y-10 cell (Lafayette part MS-225) with its ends cut off. Mounting holes were drilled in each end of the battery-clip base and also in the rear and center of the main chassis. The battery clip is then mounted. When all remaining interconnections are completed, the receiver is checked for proper operation.

### Mounting the speaker

The set is placed into its case and the position of the speaker hole marked off on the leather. A very sharp knife is used to cut a hole approximately 1/4 inch smaller in diameter than the speaker cone. A sheet of 1/32-inch bakelite is obtained and a ring cut with an inner diameter of 2 1/4 inches and an outer diameter of 2 1/2 inches. Next out of a piece of stiff speaker grillecloth, a circular piece is cut to fit exactly into the hole in the bakelite ring. The grillecloth is then cemented into place. After the cement sets the bakelite ring is glued over the speaker hole in the case and allowed to set. The battery is installed and the set placed into the case. Calibration is checked for the necessity of making an oscillator adjustment.

With the volume turned on full, signal generator connected and set up as before and an ac vtvm across the voice coil of the loudspeaker the readings for my receiver were:

Frequency (kc)	Input ( $\mu$ v)	Output (volts)	Gain (db)
600	15	0.25	84.5
1000	15	0.27	85
1600	15	0.25	84.5

The current drain from the battery is about 16 ma, which indicates a rather long battery life.

Local stations are easily received. Weaker stations can be heard by using an earphone plugged into J1. END

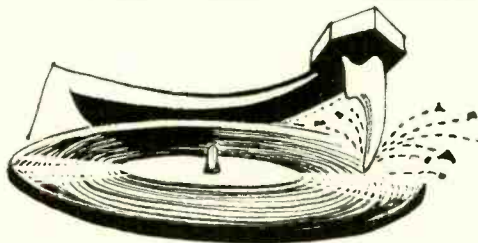

Is your pickup a  
**GROOVE DIGGER?**

Ordinary hi-fi pickups—even new models—are often highly destructive to records and styli. The chief reason is their poor compliance and large dynamic mass.

ESL electrodynamic cartridges can greatly prolong the life of your valuable records—and styli, too. Minimum lateral compliance is  $6.8 \times 10^{-6}$  cm/dyne (two to seven times that of most leading pickups), and dynamic mass is only one one-thousandth of a gram.

Not only does the ESL in this way save many times its own cost, but it also sounds better—far better. It can reproduce your records with a naturalness and clarity you've never before experienced. Hear its superiority at your dealers, and write for details.

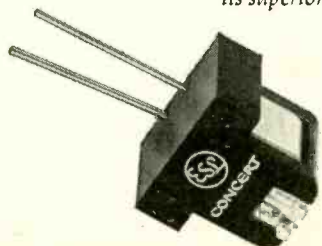

FOR LISTENING AT ITS BEST  
**Electro-Sonic Laboratories, Inc.**

Dept. E • 35-54 Thirty-sixth Street • Long Island City 6, N.Y.

Concert Series cartridge \$35.95 • Professional Series arm and cartridge \$106.50 • Dust Bug \$5.95  
NOVEMBER, 1957

**if you think**

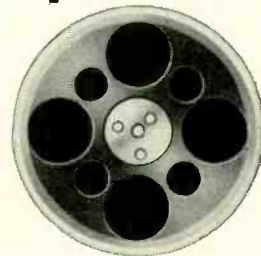

**that all brands**

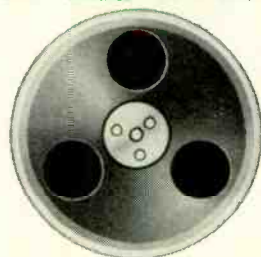

**of recording tape**



**are alike...**

**wait till you try**

**irish**  
BRAND  
**ferro-sheen!**



Available wherever quality tape is sold.  
ORRadio Industries, Inc., Opelika, Alabama  
Export: Morhan Exporting Corp., New York, N.Y.  
Canada: Atlas Radio Corp., Ltd., Toronto, Ontario



## How far can you go in Electronics without a Degree?



Bernie Roth examines ribbon from printer during Field Engineering Laboratory period.

Without a formal degree, 25-year-old Bernie Roth is already established as a Computer Systems Field Engineer—handling a key responsibility with IBM. Bernie is part of a team maintaining an entire electronic digital computer system. In this assignment, he must stay abreast of all the most advanced electronic concepts—developing his professional know-how every day. “That’s what’s different about IBM,” Bernie says. “The graduate engineer has an advantage anywhere—but here at IBM, the technician also can grow into managerial positions. IBM is one of the few organizations I know of that is willing to invest time and money in training the technical man—and then gauges his future ability strictly on performance.”

IBM instituted its program for specialized technical training many years ago. The theory behind this built-in educational system asked the question: Why should the capable man be denied the opportunity simply because he lacks a formal degree? The wisdom and foresight of IBM’s decision are reflected in the story of Bernie Roth—in the misgivings of his past—in the certainty of his future.



### The Navy steers Bernie on the right course

When Bernie graduated from Flemington, N.J., High School in 1950, he received a general diploma—mathematics and science made up a small part of his curriculum. Enlisting in the Navy in 1951, Bernie proved his aptitude for technical work and was assigned to the electronics preparatory school in Jacksonville, Fla. Later, he attended the Class A Aviation Electronics School in Memphis, Tenn. . . . probably the most important phase of his naval training because it was in



Here, he scans the schematic of computer circuits.

Memphis that he became convinced that a technical career was "Right up my alley." But an event that occurred during a furlough in the spring of 1955 put a brand-new light on Bernie's future.

### Reports for training

Bernie smiled when he mentioned that his mother had a tendency to clip want ads. "It was just pot-luck that one of the ads she spotted was for IBM Kingston and Project SAGE." Soon afterwards, Bernie hopped a bus to Newark for an interview with the IBM representative. He took the required number of tests—talked over his hopes and ambitions, and "That's about all there was to it." In July, Bernie notified IBM that he was definitely available, and supplied the necessary references. Meanwhile, he made a study of IBM's history, its policies, its growth, and its future—all of which impressed him favorably. One day in September, Bernie received instructions to report to Kingston to begin training as a Computer Units Field Engineer.

### The material he studied at Kingston

"The Kingston program is a real experience, and quite an eye-opener in

electronic techniques. First of all, I studied basic circuitry. Then, I actually learned a new way to think—the ability to comprehend the whole from the assorted parts. The student must know how to form logic blocks, and in time, he should be able to design his own circuits. All of this proved especially helpful once I got into the field. Later on, I studied the various input-output devices which are used as auxiliary units to the central computer. Finally, I analyzed the methods that supply the power for this electronic giant. Millions of



Bernie checks a unit in one of the operating consoles.

watts are needed—a phenomenal amount. In general, I'd say that you couldn't find a better training ground for understanding the uses of electronic as well as electromechanical equipment."

### Promoted to Computer Systems Field Engineer

Early this year, following additional training and on-the-job experience, Bernie became a Computer Systems Field Engineer and was assigned to Santa Monica, Calif. "I'm responsible for performance and evaluation of the system as a whole. I direct and conduct reliability testing and maintenance of computer equipment. The many Project SAGE outposts—picket ships, reconnaissance planes, Texas towers—flash their signals to input devices which, in turn, correlate and compile data for the main computer. After processing, data is available either through displayscopes, fast photographic devices, or printed data. The SAGE computer, incidentally, is the world's largest computer. It's built and tested at Kingston, then disassembled and shipped to directional control sites. My work is always different, never routine, and that's very important to me."

### How does the future look to Bernie?

A happy and prosperous future is in the offing for Bernie Roth. Now a Computer Systems Field Engineer, he's confident that in a short time he will qualify as a Group Supervisor, and the next step up the ladder would be Group Manager. "The real satisfaction in working with IBM," Bernie says, "is the opportunity to learn and understand more and more about electronic techniques. IBM is quick to recognize and reward improved ability through greater knowledge."



An outdoor man, Bernie takes full advantage of available hunting facilities.

### What about you?

Since Bernie Roth joined IBM Military Products and the Project SAGE program, opportunities are more promising than ever. IBM will invest thousands of dollars in the right men to insure the program's success.

*If you have 2 years' education and/or experience gained through technical schooling or military service, you can become a member of this important, permanent, expanding project as a Computer Units Field Engineer. You'll receive 20 weeks' training at Kingston, N. Y., with full pay, plus living allowance, before assignment to a permanent location of your choice.*

### WRITE TODAY to:

**Mr. N. H. Heyer, Room 3111  
Military Products Division  
IBM Corp., Kingston, N. Y.**

You'll receive a prompt reply. Personal interviews arranged in all areas of the United States, if your resumé of experience and education indicates you have the qualifications.



DATA PROCESSING • ELECTRIC TYPEWRITERS  
MILITARY PRODUCTS • TIME EQUIPMENT  
SPECIAL ENGINEERING PRODUCTS • SUPPLIES

# TRANSISTOR & HYBRID AUTO RADIOS

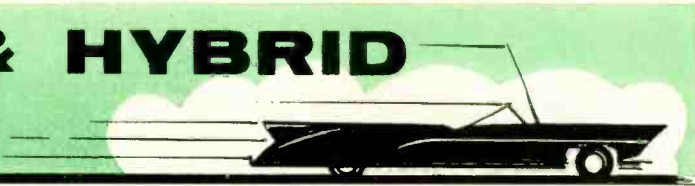

By JACK DARR

Part I—New tricks in an old trade, or “Look, Maw, no vibrator!”

**T**HE inverted technician who sticks his head under the dash of a new car is quite apt to find out that something new has been added in the auto-radio department. He is also quite apt to find that something old has been taken away! Especially, if he uses the oldest test in the book for auto radios: turning it on and listening for the vibrator!

Beginning with a few models last year and continuing in still greater numbers this year, the leading set makers are incorporating transistors in their auto radios. This is actually the first basic change in auto-radio design since the elimination of the B-battery box! Many of these sets use low-voltage tubes and transistors and thus have no high-voltage supply at all, ending the need for the familiar vibrator.

The new radios may be divided into three classes roughly speaking: the hybrid sets, using power transistors in the output, with conventional tubes in the rest of the stages; the hybrid sets using transistors for output, with the special low-voltage series of tubes, developed last year, which require only

12 volts plate or screen and, finally, the all-transistor sets. There are subclasses and variations of these, of course, which will be discussed as we go along.

Numerically, about the most popular of these seems to be the hybrid sets with power transistors in the output stage. Such transistors as Delco's 2N173, which may be superseded by the newer 2N278, Motorola's 2NJ4 (2N176, 2N178) and the Philco AR-6 and AR-5 are found here. These are all very similar in shape, differing mainly in type number and mounting methods. Driving power for these is furnished by an extra stage of audio amplification. This may be a tube or a lower-power transistor.

### Coupling transistors

Transformer coupling between stages, not seen in commercial design for some time, is making a comeback. Proper impedance matching is very important in transistor circuitry: the transistor is a fairly low-impedance device compared to the very high impedances found in tube circuitry and the matching transformer plays a very important

role. A tapped autotransformer is found in several circuits, stepping the higher output impedance of the transistor driver down to match the low input impedance of the following transistor stage.

Some single-ended circuits even use an autotransformer as an output transformer, tapping the 4-ohm speaker down on the single winding to a point 4 ohms from the ground end. After all, impedances are matched mainly to achieve maximum power transfer and the transistor is primarily a power-handling device, both on the input and output, as contrasted to the voltage-input-power-output vacuum tube. These considerations are taken care of in the design of the radio: all that the service technician is expected to do is restore the circuit to its original operating condition!

Typical of the transistorized hybrids made by Philco are the P-5701 and C-5707 radios. These sets differ mainly in their cases, using the same circuit internally. The AR-5 power transistor is used in the power output stage (see Fig. 1) and is mounted on a heat sink on one end of the chassis. The new series tubes that require only 12 volts on plate and screen are used elsewhere, eliminating the need for the vibrator and vibrator transformer.

Delco is making quite a few transistorized sets, both hybrid and all-transistor types. Typical of the hybrids is the Pontiac model, part of which is shown in Fig. 2. This is almost identical, circuit-wise, with the Chevrolet 987575, using the same tubes and transistor. A 12AF6 is used as rf amplifier; a 12AD6, oscillator-mixer; another 12AF6 in the if stage; a 12F8 detector, while the drive for the 2N173 output is furnished by a 12K5. Notice the autotransformer used as output transformer.

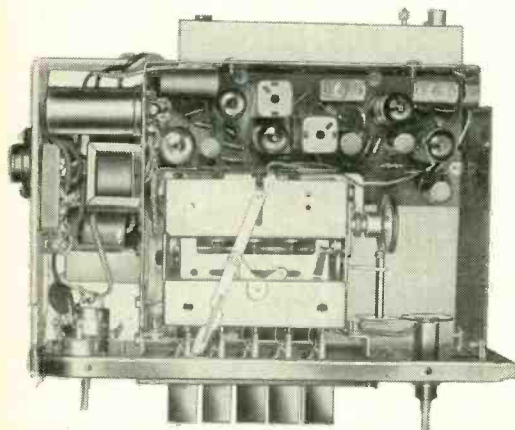

(Left) Philco P-5701 auto radio. Power transistor on heat sink at left.

(Below left) Chassis view of Corvette radio. Audio transistors and power supply transistors on separate chassis.

(Below right) Cadillac all-transistor radio. Output transistors on chassis at right.

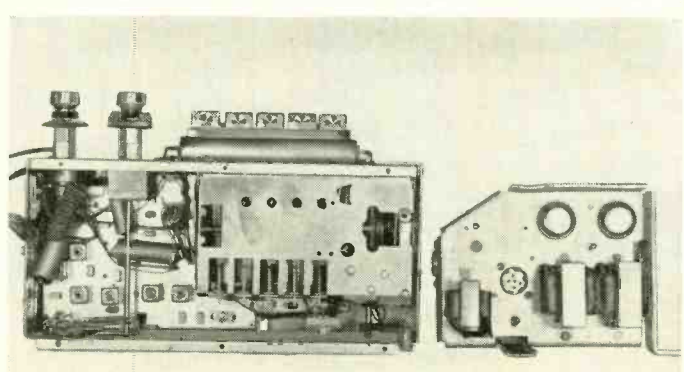
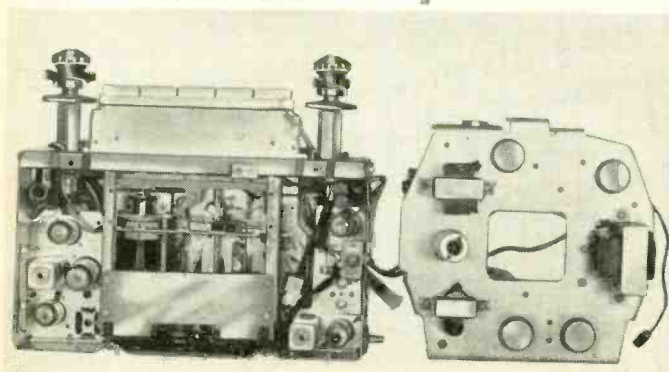

# Mr. Service Dealer...

# PHILCO

 brings you extra picture tube business and extra dollars this Fall with a hard-selling, nation-wide advertising campaign. See your PHILCO DISTRIBUTOR. Cash in on this sales-making opportunity.

MARILYN VAN DERBUR, MISS AMERICA 1958



## PHILCO Star Bright <sup>20</sup>/<sub>20</sub>

### ALUMINIZED PICTURE TUBES

Philco picture tubes give the sharpest, brightest picture on any make or model television receiver. Your old set will seem like new with a Philco Star Bright 20/20 picture tube.

**NATIONWIDE CAMPAIGN IN  
TV GUIDE AND LOCAL NEWSPAPERS  
TO RUN OVER YOUR NAME AND  
BRING CUSTOMERS INTO YOUR STORE**

To back you up this Fall Selling Season Philco is running a tremendous advertising campaign in the magazine read by over 5,000,000 tele-viewing enthusiasts . . . TV Guide. In addition, in local newspapers the story of Philco superiority is being told to millions of additional prospects all over America.

CALL ANY OF THESE SERVICE DEALERS FOR IMMEDIATE REPLACEMENT

SEE IT ALL WITH A  
**PHILCO Star Bright 20/20**  
ALUMINIZED PICTURE TUBE  
*Doubly protected by written bond and warranty*  
Brightest, sharpest picture in TV!

YOUR NAME HERE

DO NOT MISS HALF THE FOOTBALL GAMES

MAKES YOUR OLD TV LIKE NEW

TV GUIDE

**BOND**

**WARRANTY**

### DOUBLE SELLING ADVANTAGES

Only replacement picture tube for any set doubly protected by written bond and warranty.

See your PHILCO DISTRIBUTOR. CASH IN ON THIS SALES-MAKING OPPORTUNITY

# PHILCO Accessory Division

WORLD'S LARGEST DISTRIBUTOR OF

- Service Parts • Accessories • Universal Components • Power Packed Batteries • Long Life Tubes • Heavy Duty Rotors
- Star Bright 20/20 Picture Tubes • Long Distance Antennas

PHILCO ACCESSORY DIVISION  
"A" STREET AND ALLEGHENY AVENUE  
PHILADELPHIA 34, PENNSYLVANIA

Please send me further information on Philco's Star Bright 20/20 Aluminized Picture Tubes.

Name \_\_\_\_\_

Address \_\_\_\_\_

City \_\_\_\_\_ Zone \_\_\_\_\_ State \_\_\_\_\_

RE-1157

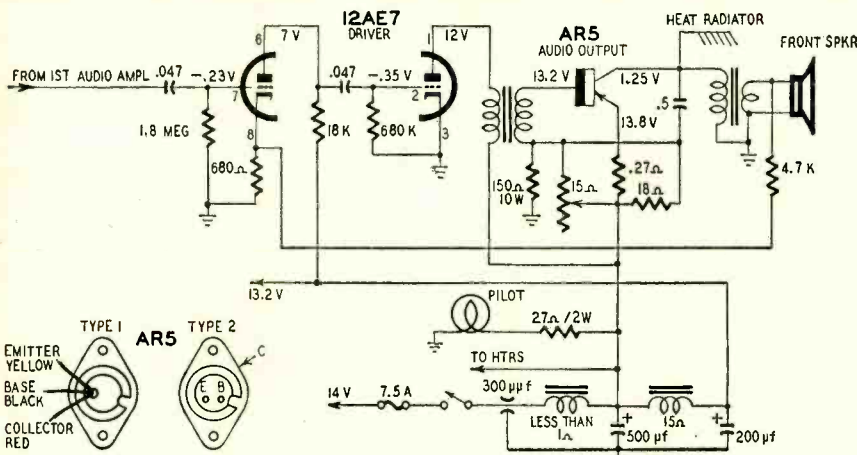

Fig. 1—Circuit of the Philco P-5701 and C-5707.

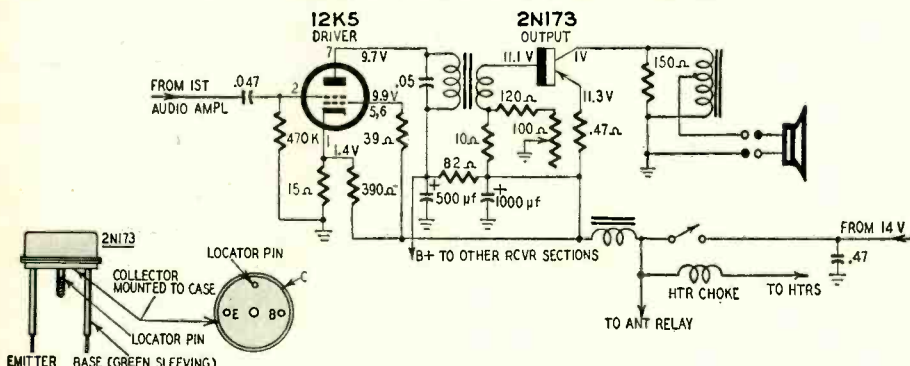

Fig. 2—Delco's Pontiac model 988671. The 12K5 grids are correct as shown.

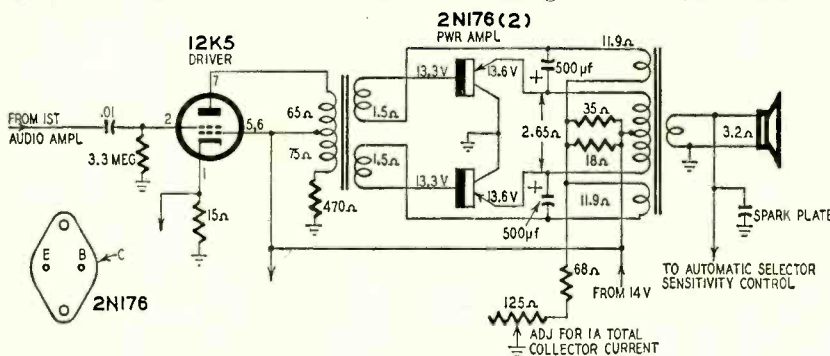

Fig. 3—Motorola 6TAS8 has push-pull transistor output stage.

Delco's first transistorized radio was the hybrid model 3725156 found in the Corvette sports car. This set has six conventional tubes, 12BA6, 12BE6, etc., in a standard circuit, with two 2N173 transistors in a push-pull power output stage.

A new application for power transistors is found in the power supply: two type 2N174's are used to replace the vibrator! (The schematic will appear in a later installment of this series.) They are hooked up in a push-pull oscillator circuit, using a special transformer. The high-voltage secondary of this is connected to a 12X4 and rectified in the normal manner. Output is about 200 volts, a customary value for auto radios.

**Delco Cadillac 7268085**

Delco's first completely transistorized radio is the model 7268085 used in the Cadillac Brougham. This set has a total of 13 transistors and 4 crystal

diodes. A 2N150 is the rf amplifier, while 2N149's are used in the oscillator, modulator (mixer) and the first and second if amplifier stages. The third if amplifier is a type R-63, the detector a type R-62, with a type R-64 used as the agc amplifier. In the output stage, a 2N109 drives a push-pull pair of 2N278's. The signal-seeking tuner in this set uses a 2N149 as the trigger amplifier, with a 2N109 as the relay control unit. Together, these two transistors replace the familiar 12AU7 used for the same purpose in previous sets.

Two speakers are used, one in front and the other in the rear seat. A fader type control selects the volume level desired for each. Using all transistors, the set does not need a high-voltage power supply; all operating voltages are supplied by the car's 12-volt battery.

The most unusual feature of this and similar sets, to the technician accustomed to the large currents drawn by older sets, will be the current drain:

2 amperes! This small drain is made possible by eliminating the vibrator, power transformer, rectifier tube and filaments which, although necessary for the functioning of the (tube) set, make no contribution to amplifying the signal. The current used by the all-transistor set is practically all applied to direct signal amplification!

Motorola's entry in the hybrid field consists of several models, beginning with a five-tube one-transistor chassis. These sets use the low-voltage tubes, with a 2N176, 2N174 or 2N178 transistor in the power output stage. Circuit-wise, they are quite similar, using a 12BL6 rf amplifier, 12AD6 converter, 12BL6 if amplifier, 12AE6 second detector-avc-amplifier and a 12K5 as a driver for the transistor. They are built to fit the 1957 Dodge, DeSoto, Plymouth, Ford, Chevrolet and other cars.

Next is a chassis using the same tube lineup except for 12AC6's in the rf and if stages. This may be used, with the proper installation kit, in 1955 and 1956 Chevrolet, Buick, Oldsmobile, Pontiac and Studebaker cars, including the Hawks. This model, the 6TAS8, has a search tuner. Battery drain, at a 12-volt input, is only 2.7 amps and power output is 2.5 watts at normal volume with a 4-watt maximum.

A six-tube one-transistor chassis with search tuning, the MoPar 918-919, is used in the Dodge and DeSoto. Tube lineup is the same as in the sets previously mentioned, with a 2N176 power transistor. A novel feature of this chassis is the mounting of the transistor on a separate chassis, with the output transformer, heat radiator, etc. This is installed on the firewall for better cooling of the transistor.

The FEG-118806-G, an eight-tube chassis, with one transistor, using search tuning, is designed for custom installation in the 1957 Fords.

Two 2N176's are used in the output. They are mounted on the back of the case, with heavy aluminum heat-radiating fins. A sensitivity control is provided on the tuner for town and country areas. Manual pushbutton tuning is also incorporated in this design. This is the familiar cam and lever type.

Possibly the most elaborate set in the line is the Ford FEJ-18806-C (Motorola 79MS) designed for the Ford Thunderbird. Its output circuit is shown in Fig. 3. Nine tubes and two transistors power this one, which incorporates the Volumatic agc circuit, described in the next installment, and the Eliminoise circuit to reduce noise pickup from power lines. Sensitivity control for the search tuner is also used.

Next month we discuss some of the interesting and different features of this new crop of auto radios. Transistor power supplies to replace the vibrator and a combined avc-agc circuit will be described. Further articles will cover servicing problems in the new radios.

TO BE CONTINUED

It's packed with career facts!

SEND FOR THIS  
**FREE**  
BOOKLET TODAY



Turn  
this page

MAIL THIS POSTAGE-FREE POSTCARD TODAY

See what  
the rapidly  
expanding  
field of  
**ELECTRONICS**  
offers you

**CAPITOL RADIO ENGINEERING INSTITUTE**

*ECPD Accredited Technical Institute Curricula. Founded 1927*

Dept. 1411-D 3224 16th St., N.W., Washington 10, D. C.

Please send me your course outline and **FREE** Illustrated Booklet "Your Future in the New World of Electronics" . . . describing opportunities and CREI home study courses in Electronic Engineering Technology.

- RA1**
- CHECK FIELD OF GREATEST INTEREST
- Electronic Engineering Technology
  - Broadcast (AM, FM, TV) Engineering Technology
  - Television Engineering Technology
  - Aeronautical Electronic Engineering Technology

Name \_\_\_\_\_ Age \_\_\_\_\_

Street \_\_\_\_\_

City \_\_\_\_\_ Zone \_\_\_\_\_ State \_\_\_\_\_

Check:  Home Study  Residence School  Korean Veteran

To help us answer your request intelligently, please give the following information:

EMPLOYED BY \_\_\_\_\_

TYPE OF PRESENT WORK \_\_\_\_\_

SCHOOL BACKGROUND \_\_\_\_\_

ELECTRONICS EXPERIENCE \_\_\_\_\_

IN WHAT BRANCH OF ELECTRONICS ARE YOU MOST INTERESTED? \_\_\_\_\_

# CREI prepares you quickly for success in

**The future is in your hands!**

The signs are plain as to the future of the trained men in the electronics industry. It is a tremendous industry, and—at the *present time* there are more jobs than there are trained men to fill them. But—when there's a choice between a trained and untrained applicant, the trained man will get the job. Your biggest problem is to decide on—and begin the best possible training program.

**CREI Home Study . . .  
The Quick Way to Get There.**



Since 1927, CREI has given thousands of ambitious young men the technical knowledge that leads to more money and security. The time-tested CREI procedure can help you, too—if you really want to be helped. CREI lessons are prepared by experts in easy-to-understand form. There is a course of instruction geared to the field in which you want to specialize. You study at your convenience, at your rate of speed. Your CREI instructors guide you carefully through the material, and grade your written work personally (not by machine).

## Industry Recognizes CREI Training.

CREI courses are prepared, and taught with an eye to the needs and demands of

industry, so your CREI diploma can open many doors for you. Countless CREI graduates now enjoy important, good-paying positions with America's most important companies. Many famous organizations have arranged CREI group training for their radio-electronics-television personnel. To name a few: All American Cables and Radio, Inc.; Canadian Broadcasting Corporation; Columbia Broadcasting System; Gates Radio Company; Hoffman Radio Corporation; Federal Electric Corporation; Glenn L. Martin Company; Douglas Aircraft Co.; Pan American Airways, Atlantic Division; U.S. Information Agency (Voice of America); Canadair Limited; Trans-Canada Air Lines; United Air Lines. Their choice for training of their own personnel is a good cue for your choice of a school.

## Benefits Felt Right Away.

Almost immediately you feel the benefits of CREI training. Your employer, when informed of your step toward advancement (only at your request), is certain to take new interest in you and in your future. What you learn in CREI Home Study can start helping you do a better job immediately.

- RADAR
- GUIDED MISSILES
- SERVO-MECHANISMS
- COMPUTERS
- AERONAUTICAL ELECTRONICS
- BROADCASTING, AM, FM, TV
- MILITARY, NAVY, CAA ELECTRONICS
- COMMUNICATIONS
- ELECTRONICS MANUFACTURING

## CREI also offers Resident Instruction

at the same high technical level—day or night, in Washington, D. C. New classes start once a month. If this instruction meets your requirements, check the coupon for Residence School catalog.

**PAYS FOR ITSELF QUICKLY.** Your very first raise could repay your investment in CREI training, and leave you a profit the very first year. Your increases in pay thereafter are all pure profit, and you'll be prepared for many more promotions and pay raises in the future years of your life.



From San Francisco Examiner

## Industry Calls for CREI Training by Name . . . So Should You!

Here you see an actual help-wanted ad, one of many which specify "CREI or equal" training. This proves that industry approves CREI training, even insists on it!

Send card today for this fact-packed booklet. It's free.



Take 2 minutes to send for this booklet right now. We'll promptly send your copy. The rest—your future—is up to you.

1st Class  
Permit No. 288-R  
Sec. 34.9 P.L.R.  
Washington, D. C.

**BUSINESS REPLY CARD**  
No Postage Stamp Necessary If Mailed in United States

3c Postage Will Be Paid By  
**CAPITOL RADIO ENGINEERING INSTITUTE**  
**3224 16th Street, N.W.**  
**Washington 10, D. C.**

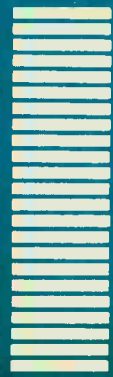

By JAMES A. McROBERTS

The transistor superhet's local oscillator and how to handle it

# SERVICING TRANSISTOR RADIOS

WHEN a transistor supplants the tube in a superhet's local oscillator, some new service problems arise. One is unfamiliarity with the circuitry of separate oscillators and oscillator sections of converters using a transistor. Another is the difficulty of determining when the oscillator is oscillating. And then there are subminiature parts and printed circuits to make servicing more difficult. Servicing procedures must follow an analysis in preference to cut and try.

### Basic action

The basic ac circuit of transistor local oscillators and oscillator sections resembles their tube counterparts as Fig. 1 illustrates. We have a black box containing an amplifier of gain  $A$  in both instances. A portion of the amplifier's output is fed back into its input. The feedback must exceed  $1/A$  as in tube circuits. Due to low resistances between the electrodes of the transistor,

the feedback in excess of  $1/A$  must be considerably greater than in tube types, where these interelectrode resistances and capacitances (B-E, B-C and C-E) are relatively nonexistent. Total feedback must be  $1/A$  plus all losses.

If feedback is to the transistor's base, phase is reversed, as indicated by polarity signs (Fig. 1-a). Feedback to the emitter does not require phase reversal (Fig. 1-b).

Gain  $A$  of the transistor is governed by its quality and the relative currents its electrodes are permitted to draw. The currents are governed by the supply voltages and circuit resistances in series with emitter, base and collector.

Assuming the transistor has sufficient gain (satisfactory transistor with proper electrode current supply), ac action is determined by the feedback circuit. The type of transistor (n-p-n or p-n-p) may be neglected in considering ac action. The circuits are similar for both types.

Fig. 2-a shows a typical converter type of local oscillator circuit abbreviated to illustrate only the rf (ac) action. The output of the transistor amplifier (from the collector) feeds through the oscillator coil's untuned winding. Output energy is transferred into the tuned winding by mutual inductance. A variable capacitor tunes this winding with the aid of an adjustable slug. Energy is fed back to the emitter via the feedback capacitor  $C_f$ . Since the emitter resistance is not bypassed to ground, the circuit acts like a grounded-grid amplifier in a vacuum-tube circuit. (The emitter is part of the base or input circuit.) Feedback is in phase here. The tap on the tuned winding fixes the amount of feedback.

Fig. 2-b illustrates base feedback. Output energy is transferred to the tuned winding as before. Out-of-phase energy is supplied the base through  $C_f$ . (Terminal 3 is in phase opposition to terminal 1.) An rf ground is required across the emitter resistance and from the end of the if transformer. The winding's capacitance furnishes a path for the oscillator current through the if transformer.

Fig. 2-c is similar to Fig. 2-b, with phase reversal being accomplished by proper connection to the pickup coil in series with the transistor's base. Since the collector is furnished with dc power through the oscillator coil, an rf ground is required at its cold end. The emitter likewise must be bypassed.

Typical commercial versions of the circuits of Fig. 2 are shown by Figs. 3,

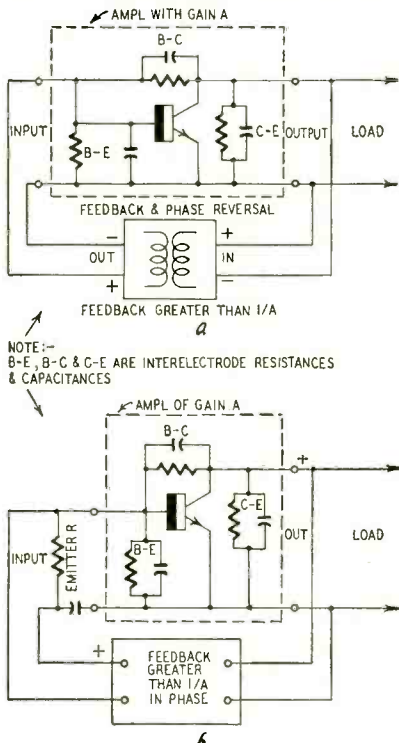

Fig. 1—Black-box analogy of transistor oscillator ac action: a—base injection type; b—emitter

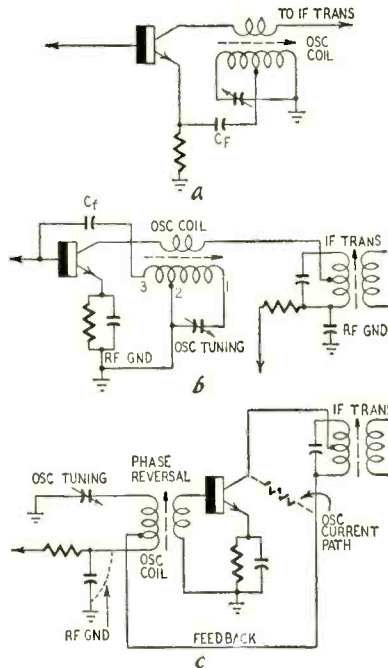

Fig. 2—Typical transistor oscillator circuits.

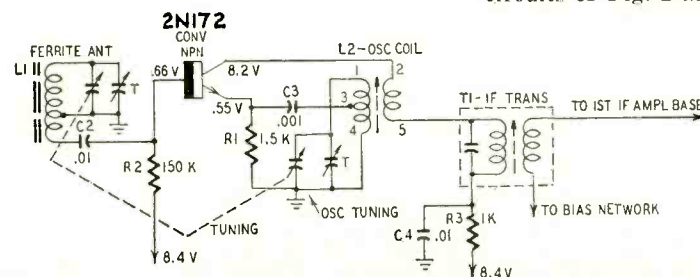
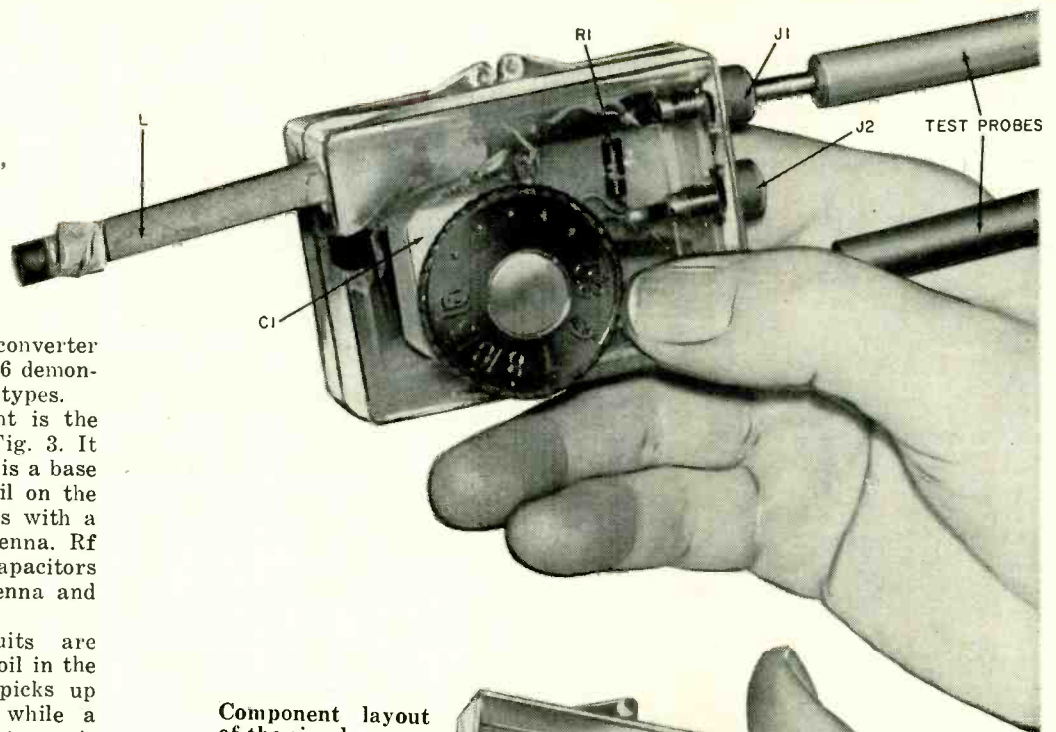

Fig. 3—Partial diagram of Westinghouse H-587-P7 converter using emitter feedback.

The wavemeter, ready to use.



4, 5 and 6. Figs. 3 and 4 are converter applications while Figs. 5 and 6 demonstrate separate local oscillator types.

Very popular at the present is the emitter injection variety of Fig. 3. It follows Fig. 2-a closely. Fig. 4 is a base feedback with the coupling coil on the oscillator transformer in series with a pickup coil on the ferrite antenna. Rf (ac) grounds are supplied by capacitors C2, C3 and C4. Both the antenna and the oscillator coil are hot.

The local oscillator circuits are straightforward. A coupling coil in the emitter return of the mixer picks up oscillator energy in Fig. 5 while a coupling coil on the ferrite antenna is furnished oscillator energy via C4 in Fig. 6. When replacing these coils, polarity may have to be reversed to maintain proper sense of feedback.

**Troubleshooting**

The first phase of troubleshooting should be directed toward learning whether the oscillator is oscillating. Since little change in voltage occurs across any resistor in a transistor oscillator, by contrast with the developed voltage across a grid leak in tube types, some substitute must be found for the voltmeter to check for oscillator action. One method is to use a working broadcast receiver. Its antenna is brought near the transistor radio's oscillator coil. If the broadcast set is tuned to some station between 950 and 1,650 kc and the tuning dial of the transistor radio is rotated, a birdie will be heard if the transistor local oscillator is functioning. Absence of a birdie means no oscillation at that frequency.

A communications type or shortwave receiver can extend the range to the 2,100 kc required to cover the entire transistor local oscillator range—most such sets employ 455 kc as the if, hence  $1,650 + 455 = 2,105$  kc. As most communications sets have an S meter or some form of avc indication, there is no need for having a station present as in the ordinary broadcast set. The meter will indicate a CW rf signal which can be identified by tuning the transistor radio dial which tunes the transistor local oscillator. The relative strength is indicated by the S meter or its equivalent.

If the shop has a grid-dip meter with wavemeter functions, it too may be used. Its coil is brought near the transistor local oscillator coil and the grid-dip meter tuning is turned slowly. The dip will indicate oscillation, and the amount

Component layout of the simple wavemeter.

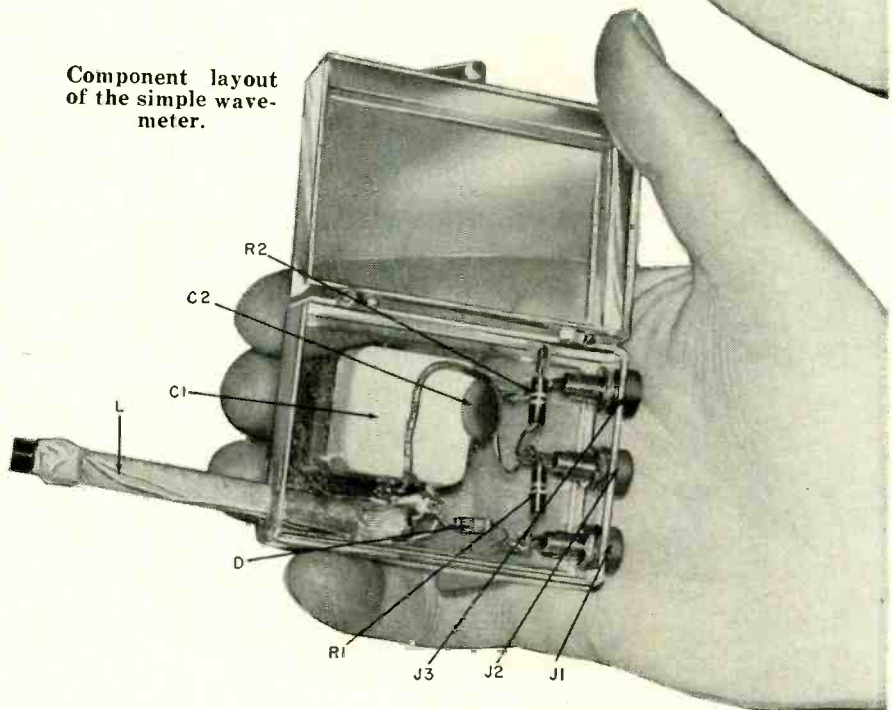

of the dip will be roughly proportional to its strength with equal distance separating oscillator and dip-meter coil.

Another alternative is a simple wavemeter, which can be constructed quickly at low cost. The schematic is presented at Fig. 7 while the photos show its construction. The ferrite antenna is modified by removing about 10 turns from the white end. It is fastened in place through a hole in the plastic case with several dabs of glue. A crystal diode rectifies any oscillatory current picked up by the antenna and tuned by the midget variable capacitor across it. The diode's dc load has two outputs to accommodate a vom or vtm. The vom is hooked between J1 and J3 and is used on its microampere range. The other output is between tip jacks J2 and J3. It is the voltage output for the vtm.

In operation the antenna is pointed at the suspect circuit's oscillator coil from a distance of about 3 inches. The dial is turned and any oscillation is revealed by a deflection of the meter. The relative strength is proportional to the meter indication, provided distance and orientation of the antenna with respect to the oscillator coil remains approximately constant.

At resonance, the pickup coil can be moved closer to the oscillator coil until the oscillator conks out. About 150  $\mu$ a can be delivered to a vom or about 2 volts to a vtm. Probe the highest frequency in a transistor oscillator since it will tend to fail there in contrast to the lowest frequency in a tube oscillator or oscillator section. Unless 50  $\mu$ a on a vom (move to a higher scale if necessary) or 1 volt on a vtm can be ob-



Why you need every feature of these

# NEW UNIVERSITY FOLDED-HORN ENCLOSURE KwiKits

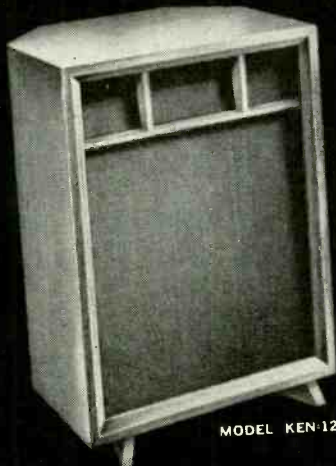

MODEL KEN-12

Because . . . in performance, mechanical design, construction and ease of assembly, these new KwiKits are unquestionably the *very finest* enclosure kits—at any price!

**KEN-12** For 12" speakers & systems  
15½" D x 21½" W x 29½" H **\$44.75**  
USER NET

**KEN-15** For 12"/15" speakers & systems  
18½" D x 29" W x 35¼" H **\$59.50**  
Adapter for mounting 12" speakers in KEN-15 \$1.50 User Net

## ROOM-BALANCED PERFORMANCE

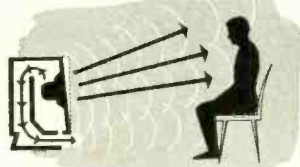

KwiKit acoustic design and tilted baffle combine direct speaker radiation and compensated rear horn loading in a way that blends bass, middle and treble ranges perfectly . . . for *uniform* response throughout the listening areas of a room.

## HEAVIER CONSTRUCTION



Heavy ¾" first grade, fully cured lumber for top, bottom, sides and back . . . *not* flimsy ½" wood commonly used in "kits." Bigger, sturdier — as *much* as 30% heavier than others in the same price class. Eliminates spurious resonances so detrimental to achieving richer, cleaner bass reproduction.

## PRECISION MECHANICAL DESIGN



Exterior and interior elements, even the cleats, fit snugly within close tolerance "rabbeted" grooves. Cluing and screwing of each piece results in reliably air-tight, permanent joints. No nails used. No pencil markings necessary. Mitering and plenty of glue blocks and bracing for truly rigid construction.

## PLACE ANYWHERE IN ROOM

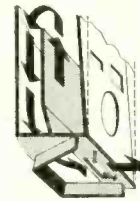

*Underside view* shows how advanced design, self-contained folded horn extends to the *front* of the cabinet, projecting low frequencies out into the room . . . not back into a corner, splashed against the walls. Small slot in base is resistively controlled vent which equalizes woofer diaphragm excursions in compression chamber. KwiKits are therefore independent of room furnishings, shape or placement and can be used against a flat wall, in a corner . . . even up in the air!

## FOOLPROOF ASSEMBLY

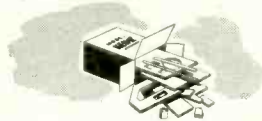

All pieces are pre-cut and pre-drilled . . . engineered to go together quickly. All you need is a screwdriver! Baffle board is pre-cut . . . blank plugs and adapters supplied for easy installation of additional components as your system expands. Your KwiKit includes all required hardware, plastic wood, glue, sandpaper, Tufflex insulation, easy-to-follow instructions and . . . special attention is given to packaging of KwiKits to insure safe, intact delivery to your door.

## PROFESSIONAL RESULTS



There's no end of decorative treatment you can give your KwiKit enclosure. Genuine Korina veneer is same as used in fine furniture, and provides a beautiful finish. Decorative front mouldings have been designed to complement and enhance your present decor. Exquisite, textured grille fabric is equally at home in settings of any period and is acoustically correct to prevent high frequency attenuation.

## KWIKITS...THE PERFECT COMPLEMENT FOR P.S.E.\*

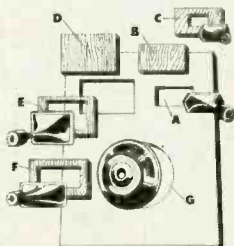

A—Hole cut out for HF-206.  
B—Blank plug supplied when tweeter isn't used.  
C—Adapter supplied cut out for UXT-5.  
D—Blank plug supplied.  
E—Adapter supplied cut out for 4409.  
F—Adapter supplied cut out for H-600 horn.  
G—Takes 312, UXC-123, Diffusicone-12, UXC-122, Diffaxials, 6200, 6201 wide-range speakers and C-12W woofer.

### MODEL KEN-12

takes any 12" wide-range or woofer cone speaker and any tweeter or mid-range speakers.

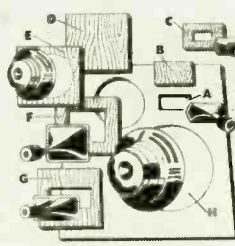

A—Hole cut out for HF-206.  
B—Blank plug supplied when tweeter isn't used.  
C—Adapter supplied cut out for UXT-5.  
D—Blank plug supplied.  
E—Adapter supplied cut out for C-8W or Diffusicone-8.  
F—Adapter supplied cut out for 4409.  
G—Adapter supplied cut out for H-600 horn.  
H—Takes 315-C, 6303, Diffusicone-15 Diffaxials, and C-15W, C-63W woofers.

### MODEL KEN-15

takes any 15" wide-range or woofer cone speaker and any tweeter or mid-range speakers.

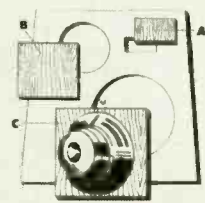

A and B—Blank plugs supplied.  
C—Takes 312, UXC-123, Diffusicone-12, UXC-122, Diffaxials, 6200, 6201 wide-range speakers and C-12W woofer.

### MODEL KEN-15

takes any 12" wide-range or woofer cone speaker when 12" adapter board (optional) is used.

\*University's Progressive Speaker Expansion Plan

UNIVERSITY LOUDSPEAKERS, INC. 80 SOUTH KENSICO AVENUE, WHITE PLAINS, N. Y.

REMEMBER . . . if you like to build your own and save money too, the KwiKit is made to order for you . . . SEE YOUR DEALER TODAY!

LISTEN

University sounds better



it's  
**NEW**

The **TRC**  
triple-duty microphone



Actual size of new TRC microphone

for hand ...



stand ...



or lavalier



it's versatile ...  
lightweight ...  
low cost, too!

Elgin's new TRC dynamic microphone offers faithful audio reproduction in the 80-8500 cps range, yet lists from \$11.50. It is designed for use with tape recorders ... yet has the versatility to perform ideally at meetings and assemblies, wherever p.a. systems are used. The TRC is less than five inches long, weighs only nine ounces, has a polished, chromeplated case. It is omnidirectional and picks up voices within a radius of ten feet under average conditions.

The TRC is also available in crystal and ceramic types.

Get the facts on this new addition to Elgin's complete line of "American" microphones. Write today for specifications and complete descriptive literature.

**ELECTRONICS DIVISION**

ELGIN NATIONAL WATCH COMPANY  
107 National Street, Elgin, Illinois



## RADIO

tained, prior to the conking out, it is advisable to replace the oscillator coil, the feedback capacitor or both to obtain a satisfactory voltage. At least this amount should be secured over the entire band. If the oscillator fails at the extreme high frequency, 2,000 kc or so, replace the transistor rather than the coil or feedback capacitor.

The dial on the instrument shown in the photos is calibrated in the rf frequency of the set being probed. The actual oscillator frequency is higher by the if, which is usually 455 kc. As an example, 1,600 on the dial actually means 2,055 kc.

### Gain troubles

If amplification A (Fig. 1 discussion) falls off as at the high-frequency end, the oscillator may stop or it may not have sufficient output for good mixing. Both troubles will be shown by the wavemeter just described.

Low gain means a bad transistor, improper voltages or defective circuitry.

First, check the voltages present at the transistor with a relatively high-resistance voltmeter. A vtvm or a 20,000-ohms-per-volt vom is satisfactory. Pay particular attention to base and emitter voltages. The emitter is almost at base voltage. Base must be a trifle more negative for a p-n-p transistor or a trifle more positive for a n-p-n type, converter operation presumed. Separate local oscillators exhibit somewhat greater base-emitter differences. Even greater tolerance is permitted at the collector in both types.

Slight creepage due to aging may upset the rather critical base-emitter differential. And base or emitter voltages, or both, may require doctoring. Easiest to operate on is the emitter. Shunt the emitter resistance with a larger-ohmage resistor or preferably a potentiometer. If the oscillator starts, as evidenced by an oscillation test, the trouble has been localized. In making a permanent replacement, use less emitter resistance than necessary to start the oscillator. The oscillating transistor must have greater gain than just enough to maintain oscillation.

This is also true for the base supply network. Usually the base supply is provided by a series resistor and another that shunts the base to ground—a bleeder resistor such as Fig. 5 shows. Here R1 (3,900 ohms) is the series resistor while R2 (2,700 ohms) is the shunt bleeder. Replacement with 5% tolerance units may be required. Such a resistance network may be shunted as a service test by a higher resistance. A pot of about 25,000 ohms makes an excellent test gadget here. Shunting the shunt resistor will lower the base voltage and a shunt across the series resistor will increase the base voltage.

Any shunt test (Fig. 5) across the emitter resistance should be across the resistance—not always from emitter to ground.

### Capacitor and coil checks

Capacitor rf bypasses are used fre-

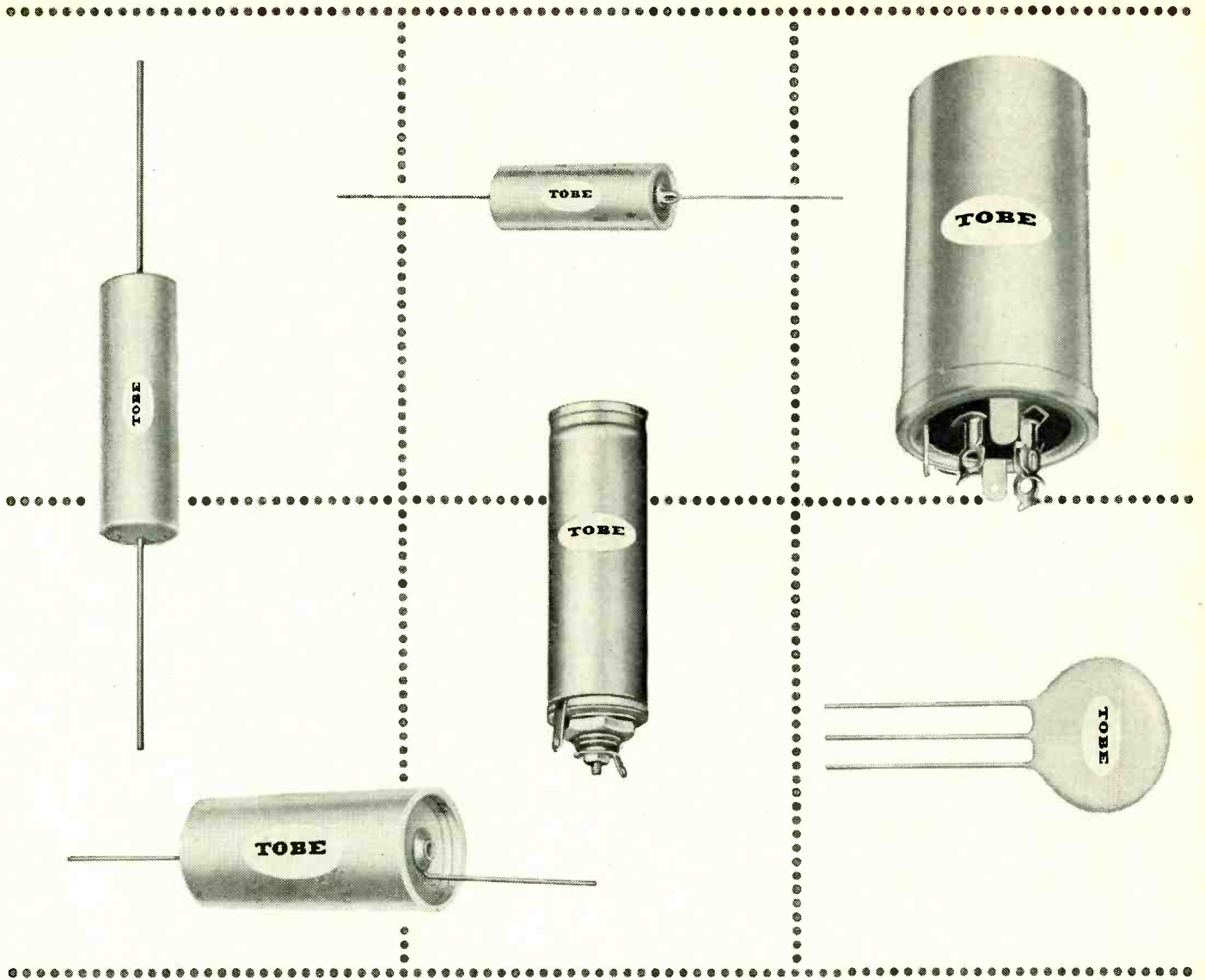

thousands of servicemen have happily discovered

# TOBE QUALITY SERVICE CAPACITORS

have you?



Specify **TOBE** Capacitors • Pioneers since 1922

# NEW STANDARD OF PERFORMANCE

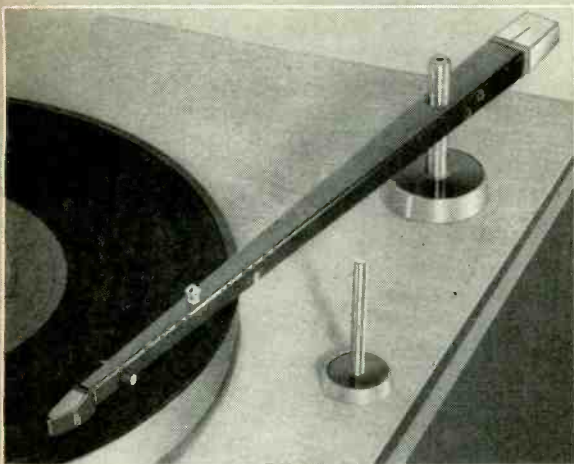

**SHURE  
STUDIO**

*Dynetic*

PHONO REPRODUCER

**IT TRACKS AT ONE GRAM!  
ITS FREQUENCY RESPONSE IS  
20 TO 20,000 CPS ( $\pm 2db$ )!**

## ONLY WITH THE STUDIO DYNETIC

- Record and needle wear are drastically reduced!
- You can completely avoid record scratches!
- You never have to level your turntable!
- You don't have to worry about groove-jumping!
- You can get superb fidelity, even from warped records!

You get the excellent response, low distortion and high compliance of dynamic cartridge construction, plus high output, minimum hum pick-up and the elimination of tone arm resonance and needle talk. There are also the additional benefits of the elimination of the pickup of low frequency rumble and motor noise. This superb unit sells for \$79.50 net. Your hi-fi dealer will be happy to arrange a demonstration.

**Write to Sales Department for reprints of informative, published articles.**

**SHURE**

*The Mark of Quality*

IN ELECTRONICS SINCE 1925

SHURE BROTHERS, INC., 222 HARTREY AVENUE, EVANSTON, ILL.

## RADIO

**Fig. 4 — Converter of RCA 7-BT-10K features base feedback.**

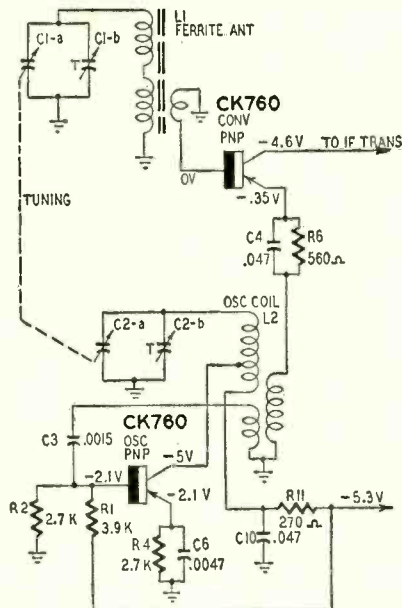
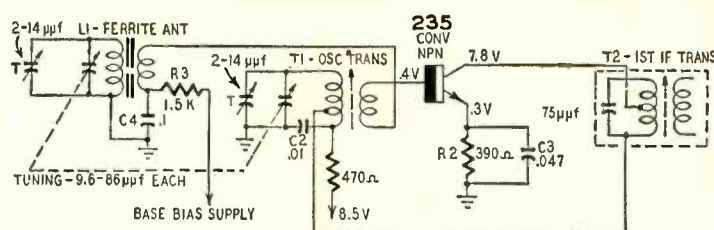

**Fig. 5—Emitter feedback from separate local oscillator in Raytheon model 8TP2.**

quently in transistor local oscillators. These can be checked by shunting with a capacitor of about the same value. The wavemeter may be left near the oscillator and tuned when each capacitor is shunted to see if the oscillator starts. Also check the coupling and feedback capacitors (such as C3 of Fig. 5, C4 of Fig. 6, C3 of Fig. 3). If any of these capacitors should lose an appreciable amount of their capacitance, the local oscillator will cut out. The same is true of excessive leakage but this will be shown by changed electrode voltages in most instances.

Most coils in the oscillator circuit may be checked by voltage measurements. If resistance checking is required, remove the transistors from their sockets to

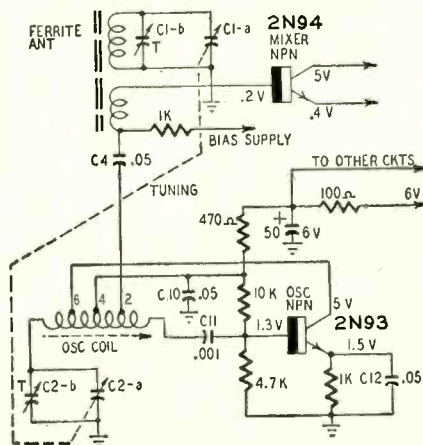

**Fig. 6—Oscillator circuit of the Zenith 500.**

prevent damage to them and erroneous readings (unless otherwise specified on the manufacturer's schematic). Be careful to observe polarity with respect to any electrolytic capacitors in the circuit—these bantam types can be ruined by reversed ohmmeter polarity. (The minus sign on a vom or vtvm may not indicate minus in the ohmmeter circuit. Find out which is which before using the instrument on transistor circuits.)

Shorting ferrite antenna coupling coils (see Fig. 4) or the if transformer section (jumper from collector to tap on oscillator coil, Fig. 4) will show up some faults without resistance checking.

Phase reversal in the circuit cannot occur unless parts have been replaced, or perhaps tested by someone previously. It is necessary that the proper phase be maintained on replacement, as mentioned in conjunction with Figs. 3, 4, 5 and 6. If the oscillator does not start after such replacement, check for reversed terminals.

## The transistor

Since the proper transistor may not be readily available for substitution checking, the elimination of other possible causes of oscillator failure is undertaken first. Testing a transistor in a transistor tester may or may not show up trouble, since cutoff frequency is not measured. Nor is the amplification measured with sufficient accuracy to predict performance in a particular type of local oscillator. Hence, substitution is the only practical way to test the transistor. Even then, check base and emitter voltage on the new transistor in place in the set, and remedy discrepancies from manufacturer's data by doctoring resistors. **END**

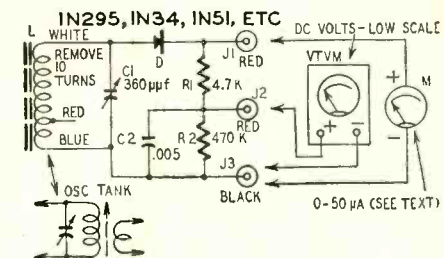

**Fig. 7—Circuit of a simple wavemeter for checking oscillator action in oscillator circuits. C1, a midjet variable, has a range of 10–365 $\mu$ mf.**

- R1—4,700 ohms, 1/2 watt
- R2—470,000 ohms, 1/2 watt
- C1—10–365  $\mu$ mf, midjet variable (Lafayette MS-274 or equivalent)
- C2—.005  $\mu$ f, ceramic
- D—IN295, IN34, IN51 or equivalent
- J1, 2—tip jacks, red
- J3—tip jack, black
- L—ferrite antenna (Lafayette MS-272 or equivalent)
- Knob
- Plastic box, 2 7/8 x 2 x 1 inch
- Miscellaneous hardware

Make **MORE** Money **FASTER** with **B&K**

LABORATORY-ACCURATE

**DYNA-QUIK**

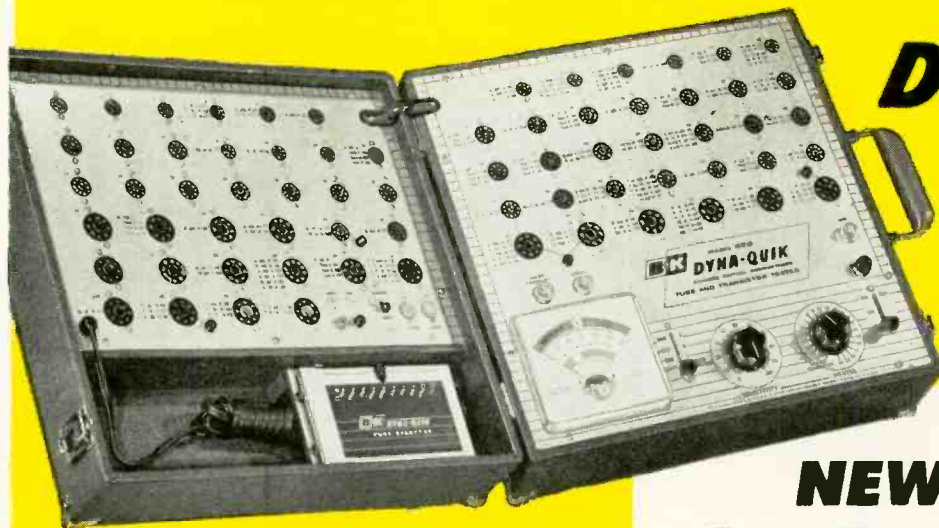

**NEW Model 650**

*Today's Fastest, Most Complete, Portable*  
**DYNAMIC MUTUAL CONDUCTANCE  
 TUBE & TRANSISTOR TESTER**

Offers New Features—More Features! Checks over 99% of the tubes most widely used in television receivers, plus popular home and portable radio tubes. Tests over 500 tube types. Lists over 125 tube types, with settings, on socket panels for maximum operating speed. Complete listing in fast telephone-index type selector. Includes 16 spare sockets and sufficient filament voltages for future new tube types. Phosphor bronze socket contacts. Tests each section of multiple tubes separately for Gm—Shorts—Grid Emission—Gas Content—and Life. Gives instantaneous Heater Continuity check. Shows tube condition on "Good-Bad" scale and in micromhos. Special bridge assures automatic line compensation. Simple to operate. No multiple switching—No roll chart. Includes pin straighteners. Transistor Tester checks junction, point contact and barrier transistors, germanium and silicon diodes, selenium and silicon rectifiers. **\$16995**  
 Net,

**CUT TESTING TIME IN HALF—DOUBLE TUBE SALES**

Measures true dynamic mutual conductance with laboratory accuracy under actual operating conditions right in the home. Makes complete tube test in seconds. Quickly detects weak or inoperative tubes. Shows customer the true condition and life expectancy of the tubes and sells more tubes right on the spot. Cuts servicing time, saves costly call-backs, wins customer confidence, and brings more profit. One extra tube sale on each of 5 calls a day pays for the Dyna-Quik in a few weeks.



**FAMOUS Model 500**

*World's Fastest Selling Portable*

**DYNAMIC MUTUAL CONDUCTANCE TUBE TESTER**

This is the B&K quick-check tube tester that has revolutionized TV set servicing! Servicemen\* say: "Best tube tester I've ever owned for speed and dependability!" "Wonderful instrument. Makes money!" "Paid for itself several times. Really indispensable!" "Have two...one for the shop and one for house calls!" "Adds income and saves unprofitable call-backs!" That is why thousands of the Model 500 are now in profitable use all over the nation. Tests tubes for Shorts, Grid Emission, Gas Content, Leakage, and Dynamic Mutual Conductance—in a matter of seconds. Life Test detects tubes with short life expectancy. Shows tube condition on "Good-Bad" scale and in micromhos. One switch tests everything. No multiple switching—No roll chart. Special bridge maintains automatic line compensation. 7-pin and 9-pin straighteners. **\$10995**  
 Net,

See your B&K Distributor,  
 or write for Bulletin 500-650-E



**B & K MANUFACTURING CO.**  
 3726 N. Southport Ave. • Chicago 13, Illinois  
 Canada: Atlas Radio Corp. 50 Wingold, Toronto 10, Ont.  
 Export: Empire Exporters, 439 Broadway, New York 13, N. Y.

\*Names on request

*Compact and easily built,  
this is a useful addition  
to any scope*

# TIME BASE

## Marker Generator

By JAMES G. ARNOLD

A TIME-BASE marker generator can be utilized in many ways with any oscilloscope. The measurement of rise and decay times of waveforms is probably its greatest application.

Users of moderate-priced scopes know that the calibration of their sweep-frequency controls is at best only a rough approximation. The sweep generator of the oscilloscope is designed to allow the synchronizing voltage to control the sweep frequency. These facts make a means for measuring time (or frequency) on a scope

highly desirable. A simple, low-cost unit which is adaptable as a modification for any scope is offered as an answer to this need.

Several methods are used to measure time on the oscilloscope screen in the more expensive instruments. One uses a closely controlled sweep circuit. The associated sweep controls are calibrated in units of time (microseconds). Another compares the waveform under observation with a sine wave of known frequency. The first method requires very complex and extensive circuitry as well as closely controlled voltages. The second is awkward since the signal must be switched off the vertical channel and the sine wave substituted. The time-base marker generator described here is a good compromise between these methods. Essentially, the observed waveform is compared with a signal of known frequency, but the signal of known frequency is applied to the intensity grid of the cathode-ray tube rather than the vertical plates. This allows the waveform under observation to remain on the screen while the time-base marker is on.

The purpose of the time-base marker

generator is to produce a train of pulses in synchronization with the oscilloscope sweep voltage. Marker pulses are spaced 1- $\mu$ sec apart and are used to blank out the trace at this interval. This results in the trace seen in Fig. 1. Time measurements on pulses and other waveforms are made by counting the number of dots between any two points on the waveform. See Fig. 2.

### Generator operation

The generator circuit is shown in Fig. 3. The sweep voltage of the scope (Fig. 4-a) is fed to the input of V1. Input amplifier V1-a is adjusted to have the proper amplitude output. This adjustment will be discussed later. The output waveform (Fig. 4-b) is fed to the grid of the damper (V1-b). The dc bias on V1-b is sufficiently below cutoff ( $E_{co}$ ) to keep the tube cut off until it is brought out of cutoff by the positive-going sweep voltage. When V1-b is cut off, the 1-mc oscillator V2-a oscillates freely. But, when V1-b conducts, the grid coil of the 1-mc oscillator is effectively shorted and no signal is fed back to the grid of V2-a. Thus the oscillator is allowed to oscillate only while the grid

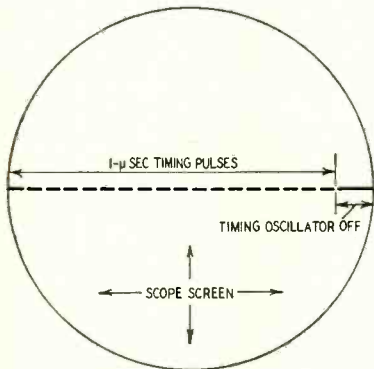

Fig. 1—How the generator affects the oscilloscope trace.

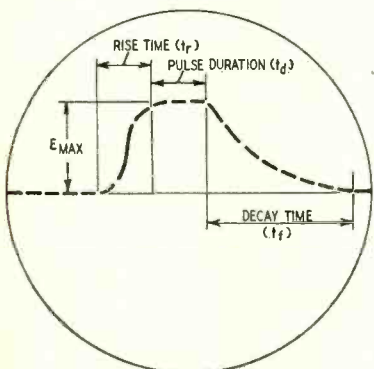
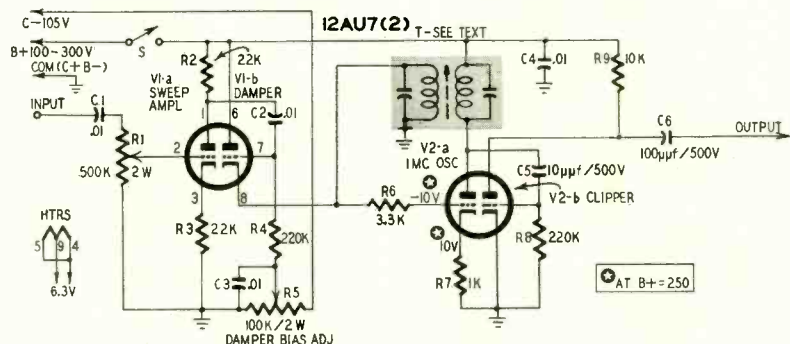

Fig. 2—Waveform with a 3- $\mu$ sec rise time and 8- $\mu$ sec decay time.



- R1—pot, 500,000 ohms, 2 watts
  - R2, 3—22,000 ohms
  - R4, 8—220,000 ohms
  - R5—pot, 100,000 ohms, 2 watts
  - R6—3,300 ohms
  - R7—1,000 ohms
  - R9—10,000 ohms
- All resistors 1/2 watt, 10%, unless noted

- C1, 2, 3, 4—.01 μf, 500 volts, ceramic
- C5—10 μf, 500 volts, mica
- C6—100 μf, 500 volts, mica
- S—Spst toggle switch
- T—1-mc tuned transformer (see text)
- V1, 2—12AU7
- Small chassis
- Sockets—(2) 9-pin miniature, shielded
- Miscellaneous hardware

Fig. 3—Circuit of the time-base marker generator.

of V1-b is held below cutoff. The oscillator output is shown in Fig. 4-c.

The output of V2-a is fed to the grid of the clipper V2-b. The signal causes this grid to draw enough current to self-bias itself. Thus only the positive peaks of the grid signal are above cutoff (Fig. 4-d) and V2-b conducts only during these peaks. The resulting output is a train of negative pulses (Fig. 4-e). Each pulse corresponds to the positive peak of a cycle of the 1-mc oscillator and therefore the pulses are spaced 1- $\mu$ sec apart.

If this train of pulses is fed to the intensity grid of the C-R tube, a blanked interval will occur in the tube trace for each microsecond pulse.

To have a series of 1- $\mu$ sec dots appear on the screen, each pulse must occur exactly where a pulse occurred on the previous sweep. This means that, regardless of the sweep frequency, the first 1-mc pulse of each sweep must occur at the same distance from the beginning of the sweep. This is accomplished by damping out the oscillator near the end of the sweep. The oscillator is then shocked back into oscillation at the beginning of the sweep by the retrace voltage (the vertical portion of the sawtooth sweep). In Fig. 4-b the damper tube bias is adjusted so that the damper is above cutoff for approximately half of the sweep period. Thus, the oscillator is on for only half the sweep length. It is not necessary to hold the oscillator off for any great length of time. The bias on V1-b is usually adjusted until a line of well defined dots extends across the screen from the extreme left to within a short distance from the right edge as in Fig. 1. A pulse is shown being displayed on this trace in Fig. 2.

**Construction techniques**

All parts are standard catalog items and are widely available with the exception of the 1-mc tuned transformer. This can be made by stripping down the windings of a standard 455-kc if transformer. The turns of each winding should be removed until the coil resonates at 1 mc with 150-200  $\mu$ f in parallel with each winding, giving the proper L-C ratio. This can be accomplished quite readily with the aid of a grid-dip meter. The parallel capacitors are then permanently mounted on the coil. A slug-tuned if transformer is preferable.

After wiring the generator and connecting the voltage supply, adjust the oscillator by placing the antenna of a shortwave receiver near the tube. Allow the oscillator to run freely by adjusting R5 for maximum bias voltage ( - 105). Tune the 1-mc transformer to a zero beat with WWV at 5 mc. This is the fifth harmonic of the oscillator. If it does not oscillate, reverse the connections of the grid winding.

The unit was constructed on a sub-chassis and mounted on the oscilloscope chassis after completion. The generator can be built on a small subchassis and mounted in a position on the scope

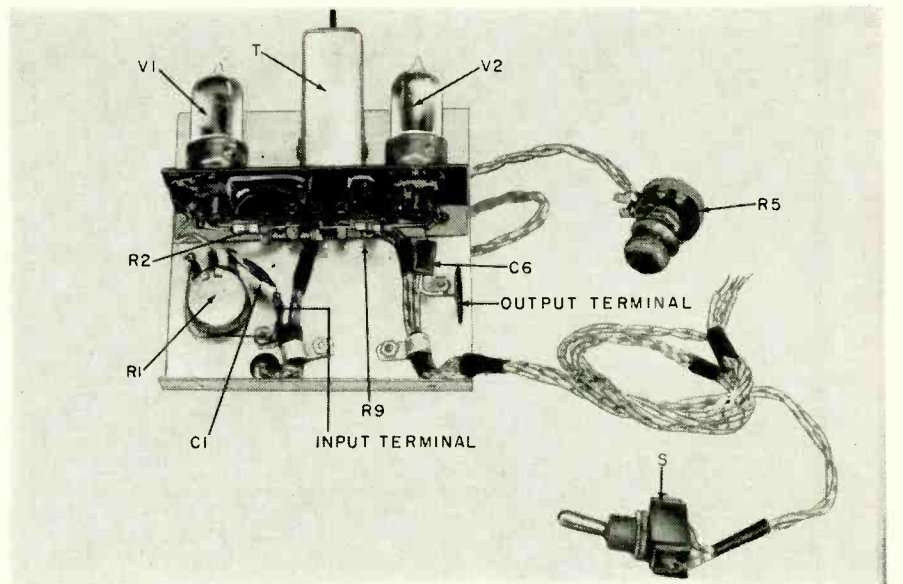

Rear view of marker generator.

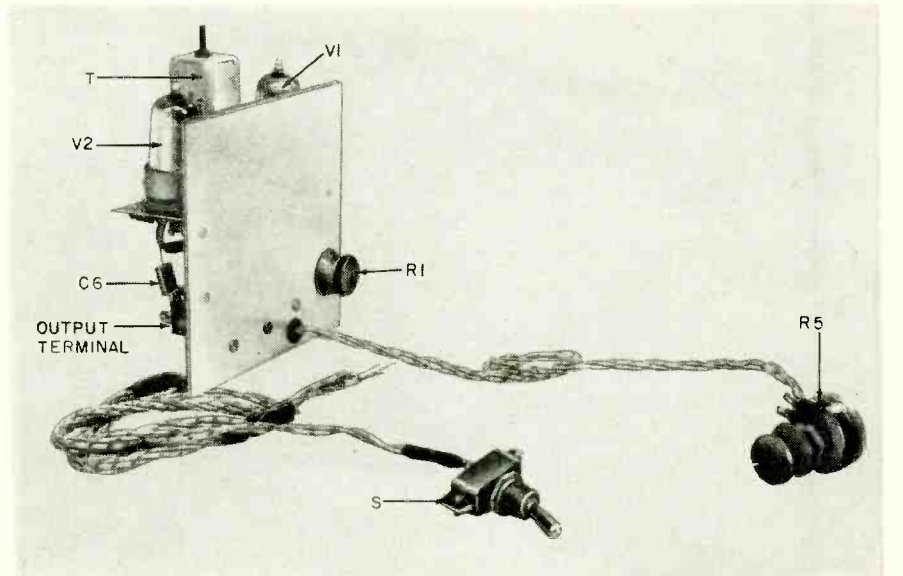

The time-base marker generator. Note its small size.

where there is some unused space. The B-plus, filament and bias leads are twisted into a neat cable and dressed along the edge of the chassis, terminating at the power supply of the scope. The B-plus lead was brought out to a front-panel spst switch to provide an on-off switch for the generator.

Potentiometer R5 is also brought out to the scope's front panel. Since this potentiometer controls only the dc bias of V1-b, its lead length does not affect the operation of the generator. Using R5 as a panel control will allow optimum operation of the time-base marker generator, regardless of sweep width.

A suitable power supply is shown in Fig. 5. The time-base marker can be used with any positive voltage from 100 to 300 dc. The unit draws about 10 ma. It is usually feasible to obtain this voltage from the scope's power supply. The negative voltage can also be taken from the scope's supply if it uses a negative supply. One ma is required for the negative voltage. In

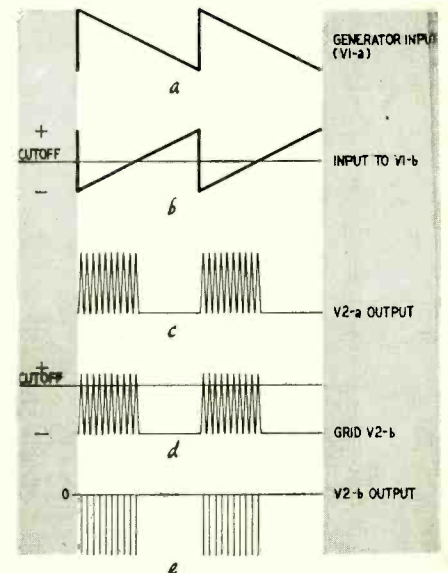

Fig. 4—Waveforms at various points in the generator.

## TEST INSTRUMENTS

the power supply (Fig. 5) either positive or negative portions may be eliminated if you desire to take either of these voltages from some existing supply.

The input is connected to the plate of the sweep amplifier or to one of the horizontal deflection plates of the C-R tube. On a 5BP1-A tube, pin 6 usually has the correct polarity. The proper connection can be determined when making final adjustments.

The output connection is shown in Fig. 6, the common arrangement of the high-voltage circuit in the majority of oscilloscopes. Components C and R are usually provided on scopes with Z-axis modulation or blanking. If they do not exist on the oscilloscope, they may be added. A good value for R is 470,000 ohms, ½ watt. Its value is not critical. C may be any value greater than 50 μmf, but it must have a voltage rating greater than the high voltage of the oscilloscope plus the B-plus voltage of the time-base marker generator. Take care to cut off all voltages and discharge the scope's high-voltage capacitors before making this connection.

### Final adjustments

After the unit is connected and mounted, final adjustments are made. Set the sweep width of the oscilloscope to just cover the entire screen. With the bias control R5 set for 0 volts, adjust R1 to the point where half the trace is covered with marker dots. If the marker dots appear on the left side of the screen, the adjustment is correct. If they appear on the right side, the input signal should be taken from the opposite deflection plate. If the scope does not have a push-pull sweep circuit (one deflection plate is grounded), it is necessary to reverse the signal polarity by disconnecting C2 from the plate of V1-a and connecting it to the cathode. The same procedure is used for adjusting the signal input to the point where half the screen is covered

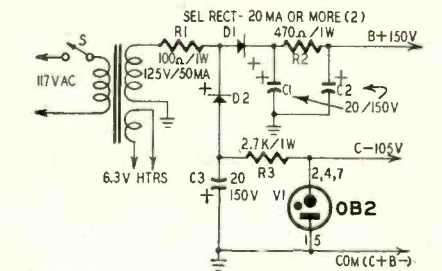

- R1—100 ohms, 1 watt
- R2—470 ohms, 1 watt
- R3—2,700 ohms, 1 watt
- C1, 2, 3—20 μf, 150 volts
- D1, 2—20-ma selenium rectifier (Federal 1159 or equivalent)
- S—Spst toggle switch
- T—Power transformer, primary 117 volts; secondary 125 volts, 50 ma, 6.3 volts, 2 amp (Stancor PA-8421 or equivalent)
- V1—0B2, voltage regulator

Fig. 5—Power supply for the time-base marker generator.

with marker dots. When the adjustments are completed, the unit is ready for use.

In optimizing the marker generator for any particular sweep width, potentiometer R5 is turned past the point where all the trace is covered with dots. This increases the bias on V1-b. This bias is increased to the point just before the dots begin to blur. (When the dots blur, the oscillator is not being interrupted sufficiently to start oscillating at the same point on each sweep.) This will produce a well defined series of marker dots. By counting the dots between any two points on the trace, the time between these two points is measured. The number of dots seen on the scope is equal to the number of microseconds.

Possibly the most basic application of a time-base marker is that of frequency measurement. With a sine-wave on the oscilloscope screen, the time-base marker dots are counted across any complete cycle of the sine wave under measurement. This is the time period of one full cycle of the sine wave. The frequency can then be found by the

$$\text{formula: } f = \frac{1,000,000}{t}$$

where t is the number of marker dots counted and f the frequency in cycles per second.

An excellent application for a time-base marker is found in testing amplifier response with a square-wave generator. Normally the square-wave method gives only an indication of "good" or "poor" response. By using the time-base marker, the actual high-frequency

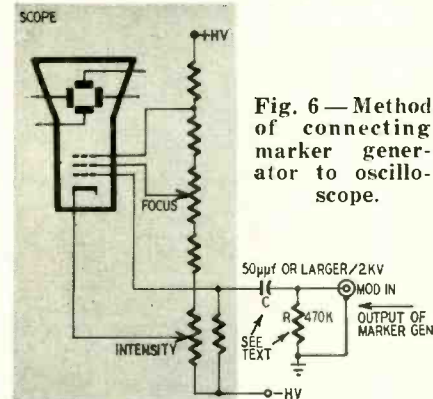

Fig. 6—Method of connecting marker generator to oscilloscope.

response can be determined. Count the number of dots that occur while the square wave rises from zero to 63% of its peak value. Then use the formula:

$$f_0 = \frac{159,000}{t}$$

where t is the number of dots counted and f<sub>0</sub> the high-frequency 3-db point in cycles per second.

TV receiver servicing can be aided by a time-base marker—waveforms may be truly checked rather than "just looked at." To the experimenter, a time-base marker is indispensable in any waveform applications. Serious photographers can use the instrument and a scope to measure the peak and duration of light from various types of photoflash lamps and to check the shutter action and accuracy at different speed settings. END



**Picture of a smart TV technician making a dollar a minute on his way back from lunch**

**\* "Naturally... it's the GOLD Twilight Antenna by Winegard Co. RE-11 BURLINGTON, IOWA"**



# FULL **C** **O** **L** **O** **R** TV

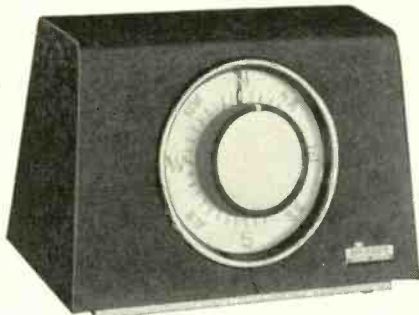

**MODEL U-98**—first and finest fully automatic rotator. Eye-appealing decorator colors—Ivory, Forest Green and Standard Mahogany Grain. Retail . . . . . \$44.25



**MODEL T-12**—with exclusive Tenna-Teller Pointer—highly accurate. Striking, modern design. Forest Green and Ivory or Standard Mahogany. Retail . . . \$34.25  
Decorator Colors priced \$2.00 extra.

## demands reliable



**DON'T ASK VIEWERS TO PUT UP WITH A 'STAY-PUT' ANTENNA!**

- TV authorities admit the higher sensitivity of color.\*
- Viewers won't tolerate weak, washed out color!
- Maximum directivity with ALLIANCE TENNA-ROTOR is the best insurance for top antenna performance—for FULL COLOR!

**Wherever you find Color TV, it will pay you to recommend Alliance!**

- Every color TV buyer is a potential Tenna-Rotor sale . . . even in metropolitan areas. Because the "**fringe**" area for color is closer to the transmitter! Viewers who might tolerate black and white TV that's "so-so", will **not** put up with irritating, "ghosty" color. And independent interviews **at point of sale** show that color TV customers find it **easy** to say Yes to Alliance Tenna-Rotor!

*\*Many TV authorities agree that color is more sensitive than black and white. "Chromatic gradation" with color that's ghosty, is harder on the eyes than black and white. Many recommend properly installed outdoor antennas with rotators, to improve directivity of the antenna, to help overcome interference and reduce annoying effects caused by the higher sensitivity of color, and the normal characteristic of color to "drop out" quicker.*

### Meet the Constant Changes in Television!

Alliance Tenna-Rotor makes any good outside antenna more directional. New stations, channel changes, new towers, more power, UHF-VHF and **NOW COLOR!** They all add up to Alliance Tenna-Rotor!

**THE ALLIANCE  
MANUFACTURING COMPANY, INC.**

(Division of Consolidated Electronics Industries Corp.)

**ALLIANCE, OHIO**

In Canada—ALLIANCE MOTORS, Schell Avenue, Toronto 10

# 2-TRANSISTOR SIGNAL GENERATOR

*Portable unit operates over broadcast band—can be used for intercom work*

By JOSEPH CHERNOF

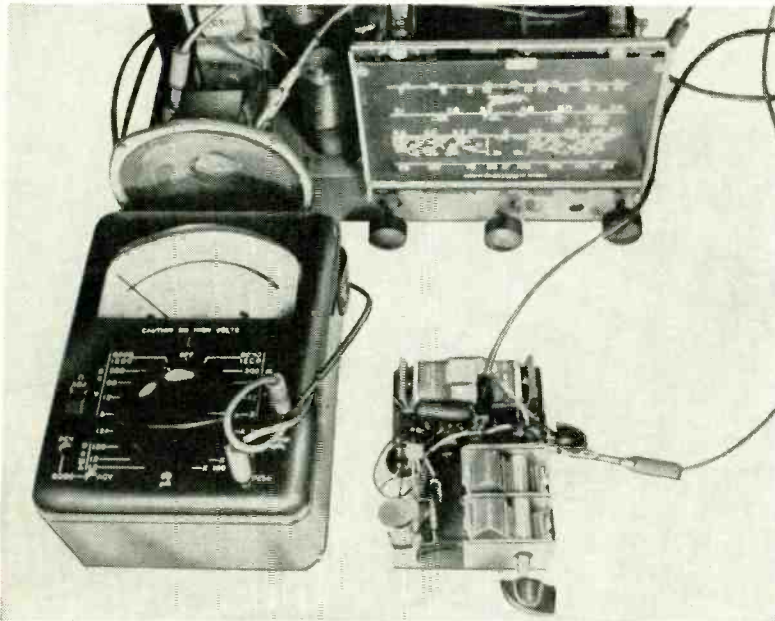
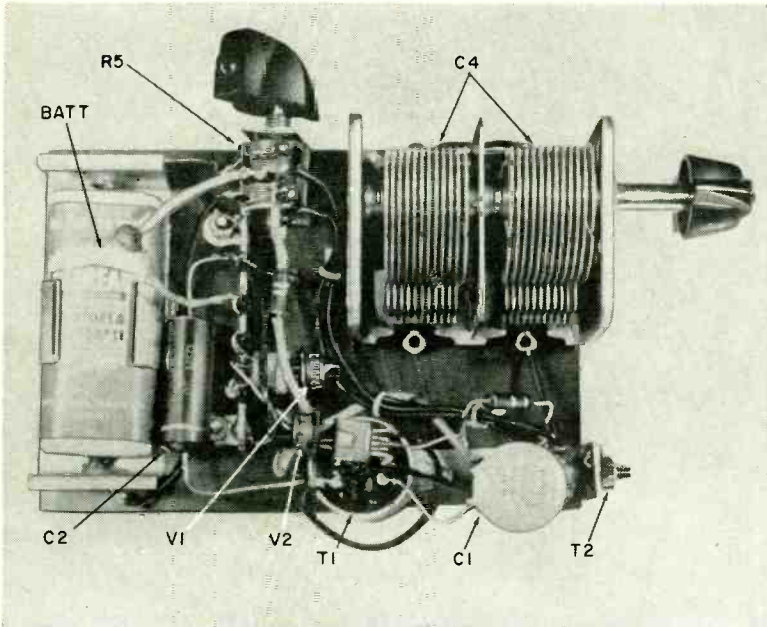

Top—Components layout of signal generator.  
Bottom—Checking receiver with signal generator.

Schematic diagram of transistorized signal generator—has af and rf oscillators.

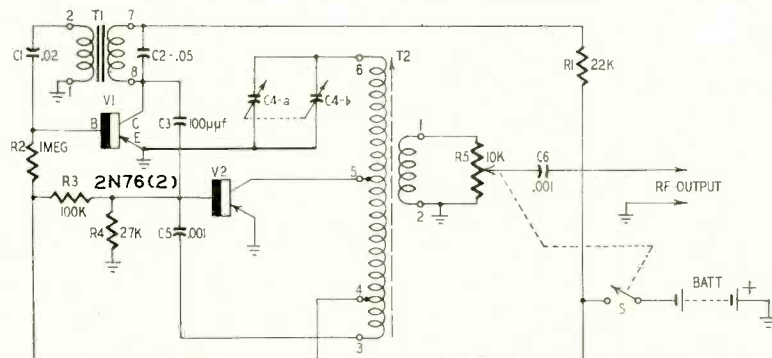

A POCKET-SIZED signal generator is a handy gadget for any electronic lab or workshop. This transistorized unit (see diagram) covers the entire broadcast band (550–1700 kc), has a self-contained source of audio modulation and makes a useful signal generator for working in the field. It can also be used as a low-power transmitter for broadcasting through home radios or as part of a transistor intercom installation when fed by a suitable microphone. The generator draws only 2 ma from a 30-volt B battery, yet puts out a minimum of 3 volts rf throughout its tuning range.

G-E 2N76 p-n-p junction transistors are used in both the rf and af oscillator stages since a number of these units gave very consistent performance in this circuit. Using an rf transistor such as the G-E 2N78, with the proper coil and capacitor combination, would extend the tuning range of the unit to about 5 mc.

Feedback necessary to sustain rf oscillation with transistor V2 is provided through tapped windings on T2, a special transistor oscillator coil de-

**Parts for transistorized signal generator**

- R1—22,000 ohms
- R2—1 megohm
- R3—100,000 ohms
- R4—27,000 ohms
- R5—10,000-ohm pot., miniature, with spst switch
- All fixed resistors 1/2 watt, 10%
- C1—.02  $\mu$ f
- C2—.05  $\mu$ f
- C3—100  $\mu$ f
- C4—2-gang tuning capacitor, 10-365  $\mu$ f
- C5, C6—.001  $\mu$ f
- BATT—30-volt miniature B battery (Eveready 413 or equivalent)
- V1, V2—2N76 transistors
- T1—miniature interstage audio transformer; primary resistance 15,000 ohms, secondary impedance 95,000 ohms (UTC O-7 Ouncer or equivalent)
- T2—transistor oscillator coil, Miller 2023
- S—spst switch on R5
- Transistor sockets (2)
- Battery holder
- Phenolic sheet, 1/8 inch, approximately 3 x 4 inches
- Knobs (2)

# BUILD 16 RADIO

## CIRCUITS AT HOME

with the New Deluxe

PROGRESSIVE RADIO "EDU-KIT"

only

# \$22<sup>95</sup>

Reg. U.S. Pat. Off.



### A COMPLETE RADIO COURSE

Now Also Includes

★ TRANSMITTER

★ SIGNAL TRACER

★ SIGNAL INJECTOR

★ CODE OSCILLATOR

★ No Knowledge of Radio Necessary

★ No Additional Parts or Tools Needed

★ EXCELLENT BACKGROUND FOR TV

★ School Inquiries Invited

★ Attractively Gift Packed

### NO NEED TO SPEND HUNDREDS OF DOLLARS FOR A RADIO COURSE

The "Edu-Kit" offers you an outstanding PRACTICAL HOME RADIO COURSE at a rock-bottom price. Our Kit is designed to train Radio & Electronics Technicians, making use of the most modern methods of home training. You will learn radio theory, construction practice and servicing.

You will learn how to build radios, using regular schematics; how to wire and solder in a professional manner; how to service radios. You will work with the standard type of punched metal chassis as well as the latest development of Printed Circuit chassis.

You will learn the basic principles of radio. You will construct, study and work with RF and AF amplifiers and oscillators, detectors, rectifiers, test equipment. You will learn and practice code, using the Progressive Code Oscillator. You will learn and practice trouble-shooting, using the Progressive Signal Tracer, Progressive Signal Injector, Progressive Dynamic Radio & Electronics Tester & the accompanying instructional material.

You will receive training for the Novice, Technician and General Classes of F.C.C. Radio Amateur Licenses. You will build 16 Receiver, Transmitter, Code Oscillator, Signal Tracer and Signal Injector circuits, and learn how to operate them. You will receive an excellent background for Television.

Absolutely no previous knowledge of radio or science is required. The "Edu-Kit" is the product of many years of teaching and engineering experience. The "Edu-Kit" will provide you with a basic education in Electronics and Radio, worth many times the complete price of \$22.95. The Signal Tracer alone is worth more than the price of the entire Kit.

### THE KIT FOR EVERYONE

You do not need the slightest background in radio or science. Whether you are interested in Radio & Electronics because you want an interesting hobby, a well paying business or a job with a future, you will find the "Edu-Kit" a worth-while investment.

Many thousands of individuals of all ages and backgrounds have successfully used the "Edu-Kit" in more than 79 countries of the world. The "Edu-Kit" has been carefully designed, step by step, so that you cannot make a mistake. The "Edu-Kit" allows you to teach yourself at your own rate. No instructor is necessary.

### PROGRESSIVE TEACHING METHOD

The Progressive Radio "Edu-Kit" is the foremost educational radio kit in the world, and is universally accepted as the standard in the field of electronics training. The "Edu-Kit" uses the modern educational principle of "Learn by Doing." Therefore you construct, learn schematics, study theory, practice trouble-shooting—all in a closely integrated program designed to provide an easily-learned, thorough and interesting background in radio.

You begin by examining the various radio parts of the "Edu-Kit." You then learn the function, theory and wiring of these parts. Then you build a simple radio. With this first set you will enjoy listening to regular broadcast stations, learn theory, practice testing and trouble-shooting. Then you build a more advanced radio, learn more advanced theory and techniques. Gradually, in a progressive manner, and at your own rate, you will find yourself constructing more advanced multi-tube radio circuits, and doing work like a professional Radio Technician.

Included in the "Edu-Kit" course are sixteen Receiver, Transmitter, Code Oscillator, Signal Tracer, and Signal Injector circuits. These are not unprofessional "breadboard" experiments, but genuine radio circuits, constructed by means of professional wiring and soldering on metal chassis, plus the new method of radio construction known as "Printed Circuitry." These circuits operate on your regular AC or DC house current.

### A COMPLETE RADIO COURSE—NOTHING ELSE TO BUY

You will receive all parts and instructions necessary to build 16 different radio and electronics circuits, each guaranteed to operate. Our Kits contain tubes, tube sockets, variable, electrolytic, mica, ceramic and paper dielectric condensers, resistors, tie strips, coils, hardware, tubing, punched metal chassis, Instruction Manuals, wire, solder, etc.

In addition, you receive Printed Circuit materials, including Printed Circuit chassis, special tube sockets, hardware and instructions. You also receive a useful set of tools; a professional electric soldering iron, and a self-powered Dynamic Radio & Electronics Tester. The "Edu-Kit" also includes Code Instructions and the Progressive Code Oscillator, in addition to F.C.C.-type Questions and Answers for Radio Amateur License training. You will also receive lessons for servicing with the Progressive Signal Tracer and the Progressive Signal Injector, a High Fidelity Guide and a Quiz Book. You receive all parts, tools, instructions, etc. There is nothing else to buy. Everything is yours to keep.

### PRINTED CIRCUITRY

At no increase in price, the "Edu-Kit" now includes Printed Circuitry. You build a Printed Circuit Signal Injector, a unique servicing instrument that can detect many Radio and TV troubles. This revolutionary new technique of radio construction is now becoming popular in commercial radio and TV sets.

A Printed Circuit is a special insulated chassis on which has been deposited a conducting material which takes the place of wiring. The various parts are merely plugged in and soldered to terminals.

Printed Circuitry forms the very basis of Automation Electronics.

### FREE EXTRAS

- SET OF TOOLS
- SOLDERING IRON
- ELECTRONIC TESTER
- TESTER INSTRUCTION MANUAL
- HIGH FIDELITY GUIDE
- QUIZZES
- TELEVISION BOOK
- RADIO TROUBLE-SHOOTING BOOK
- MEMBERSHIP IN RADIO-TV CLUB
- CONSULTATION SERVICE
- FCC AMATEUR LICENSE TRAINING
- PRINTED CIRCUITRY
- PLIERS-CUTTERS
- ALIGNMENT TOOL
- CERTIFICATE OF MERIT

### SERVICING LESSONS

You will learn trouble-shooting and servicing in a progressive manner. You will practice repairs on the sets that you construct. You will learn symptoms and causes of troubles in home, portable and car radios. You will learn how to use the professional Signal Tracer, the unique Signal Injector and the dynamic Radio & Electronics Tester. While you are learning in this practical way, you will be able to do many a repair job for your friends and neighbors, and charge fees which will far exceed the price of the "Edu-Kit." Our Consultation Service will help you with any technical problems you may have.

J. Statatius, of 25 Poplar Pl., Waterbury, Conn., writes: "I have repaired several sets for my friends, and made money. The "Edu-Kit" paid for itself. I was ready to spend \$240 for a course, but I found your ad and sent for your Kit."

### FROM OUR MAIL BAG

Ben Valerio, P. O. Box 21, Magna, Utah: "The Edu-Kits are wonderful. Here I am sending you the questions and also the answers for them. I have been in Radio for the last seven years, but like to work with Radio Kits, and like to build Radio Testing Equipment. I enjoyed every minute I worked with the different kits; the Signal Tracer works fine. Also like to let you know that I feel proud of becoming a member of your Radio-TV Club."

Robert L. Shuff, 1534 Monroe Ave., Huntington, W. Va.: "Thought I would drop you a few lines to say that I received my Edu-Kit, and was really amazed that such a bargain can be had at such a low price. I have already started repairing radios and phonographs. My friends were really surprised to see me get into the swing of it so quickly. The Troubleshooting Tester that comes with the Kit is really swell, and finds the trouble, if there is any to be found."

### UNCONDITIONAL MONEY-BACK GUARANTEE

ORDER DIRECT FROM AD  
RECEIVE FREE BONUS RESISTOR AND CONDENSER KITS WORTH \$7.00

- Send "Edu-Kit" Postpaid. I enclose full payment of \$22.95.
- Send "Edu-Kit" C.O.D. I will pay \$22.95 plus postage.
- Send me FREE additional information describing "Edu-Kit."

Name

Address

PROGRESSIVE "EDU-KITS", INC.

497 Union Ave., Dept. 134G, Brooklyn 11, N. Y.

## TEST INSTRUMENTS

signed by J. W. Miller to provide proper impedance and phase relationships for optimum performance with transistor circuits. The primary of T2 is tuned by C4-a and C4-b, a two-gang standard broadcast-band tuning capacitor with both sections connected in parallel. A second tuning adjustment is provided by the adjustable ferrite core in T2. However, it was found that with the core adjustment on T2 screwed in about as far as it would go, C4-a and C4-b were adequate to cover the entire broadcast band.

Resistors R3 and R4 supply the proper dc bias to the base of V2, and C5 provides dc isolation while at the same time feeding rf energy back. Resistor R5, a miniature Clarostat potentiometer and switch assembly, serves as the rf output control, and C6 as rf output capacitor.

Feedback for af oscillator transistor V1 is provided by transformer T1, a UTC O-7. Almost any interstage type transformer with about a 3-to-1 turns ratio could be used as long as the higher-impedance winding goes to the collector of V1 and the lower-impedance winding to the base. Base bias for V1, supplied by R2 and R1, reduces total current drain of the stage to an extremely low figure.

With C2 connected across the secondary of T1 this circuit oscillates at about 5,000 cycles. A larger transformer with more inductance in the windings would lower this frequency considerably and C2 could probably be eliminated. The af output of V1 is coupled to the base of V2 through C3, producing fairly clean modulation of the rf carrier.

The 30-volt miniature B battery is mounted in a miniature battery holder now available commercially. Both 2N76 transistors are plugged into standard transistor sockets. This type of installation is preferable to making direct soldered connections to the transistor leads, risking damage by overheating.

The entire unit is built up on a 1/8-inch-thick phenolic block, 3 inches wide and 4 inches long. The relatively large size of the tuning capacitor prevents using a smaller base. In transmitter or intercom applications V1 should be disabled. Then, fairly good voice modulation may be obtained by opening the connection to ground of the emitter element of V2 and inserting a carbon microphone in series.

The signal generator dial may be calibrated with the help of a home radio, by zero-beating its output against local broadcast stations of known frequency. Tune in a station around 600 kc and then, starting at the low-frequency end, tune the signal generator for a null between two whistles. Mark the dial with the station frequency. Repeat the operation on other stations every 20 kc or so across the broadcast band. The frequency stability of transistor oscillators is not exceptionally good so calibration should be rechecked frequently.

END

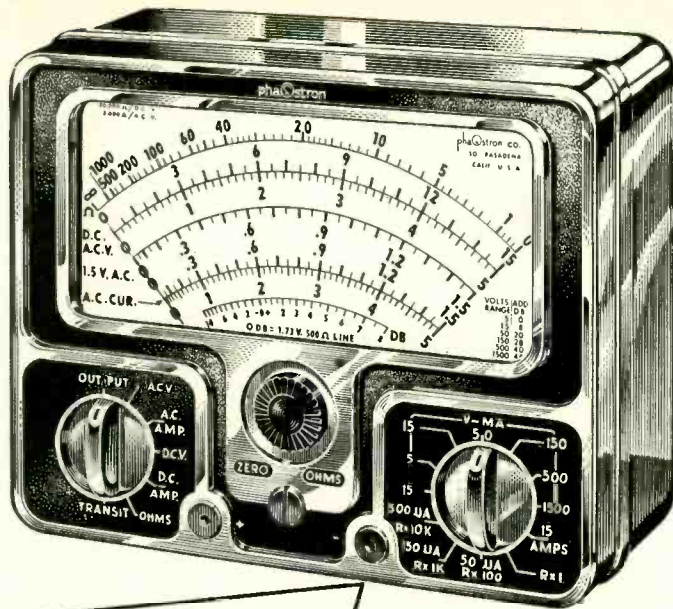

# PHAOSTRON

## 555A VOM

### YOU NEED THESE FEATURES:

Meter Movement Protection up to 500 times overload is provided by a rectifier network.

The 555A Measures: AC Current, DC Current, AC Voltage, DC Voltage, Output, Resistance

43 Unduplicated Ranges

Separate Range and Function Switches

Double Magnetic Shielding

3% DC, 4% AC Permanent Accuracy

Easy to Read, Four Color Scales 4 7/8" long

Metal Case with Die Cast Bezel 6 1/8" x 4 5/8" x 2 1/8"

Sensitivity: 20,000 Ohms/Volt DC, 2000 Ohms/Volt AC

**NEW LOW PRICE**

Not \$49.50, but priced lower than ever before. Complete with probes and batteries. (Replaces former model 555)

**NOW ONLY**

**\$44<sup>95</sup>**

**PHAOSTRON INSTRUMENT AND ELECTRONIC COMPANY**

151 Pasadena Avenue, South Pasadena, California

Practical CBS Transistor Home-Study Course

# Learn all about transistors by using them



## PREPARE NOW FOR THE FUTURE!

Let's face it. Transistors are here . . . now! Advancement opportunities are waiting for those who know all about their basic fundamentals. Are *you* ready?

This new, profusely illustrated Transistor Home-Study Course, a CBS first, was written to make it easy for you to learn by using transistors. Service-dealers . . . technicians . . . and engineers find this residence-course-at-home both fast and fascinating. What you learn you remember because you do it yourself . . . by making several practical transistor devices which you can keep and use. Course was written for CBS by A. C. W. Saunders, a well-known educator and author.

Check the table of contents. Then read how easy it is for you to start your Transistor Course today.

### CBS Transistor Course Includes

- Ten intensive lessons (with 3-ring binder) . . . up-to-date, complete
- Simplified basic theory . . . how transistors work
- Practical experiments and servicing techniques for: Amplifiers . . . applications in all fundamental circuits  
Oscillators . . . a-f, r-f, relaxation, multivibrator, special TV  
Rectifiers . . . diode and transistor rectifiers and detectors  
Practical commercial applications . . . immediate and future
- With free correction and consulting service . . . and up-to-date supplements for certified graduates

### HOW TO GET IT

Call your CBS Tube distributor. He'll tell you how to get the CBS Transistor Home-Study Course, PA-175. See him, or write us . . . today!



**CBS - HYTRON**, Danvers, Mass.  
A Division of  
Columbia Broadcasting System, Inc.



# phase-shift comparator measures frequency ratios, modulation

Add this attachment to your scope to measure audio frequencies. Also checks modulation percentages

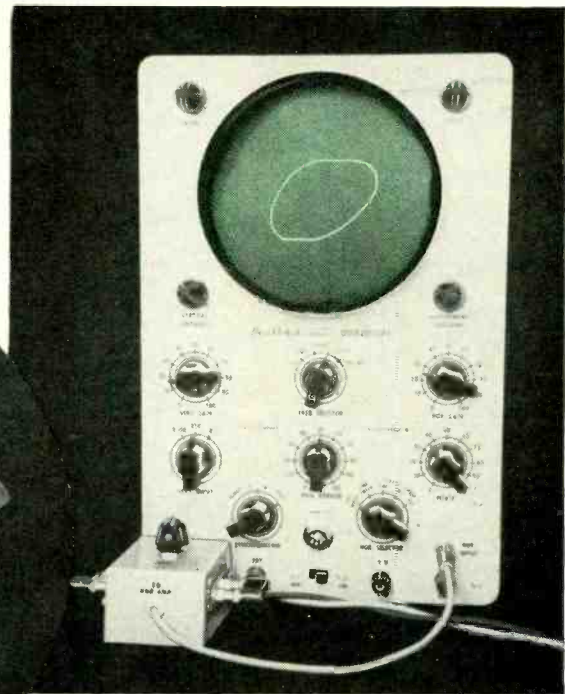
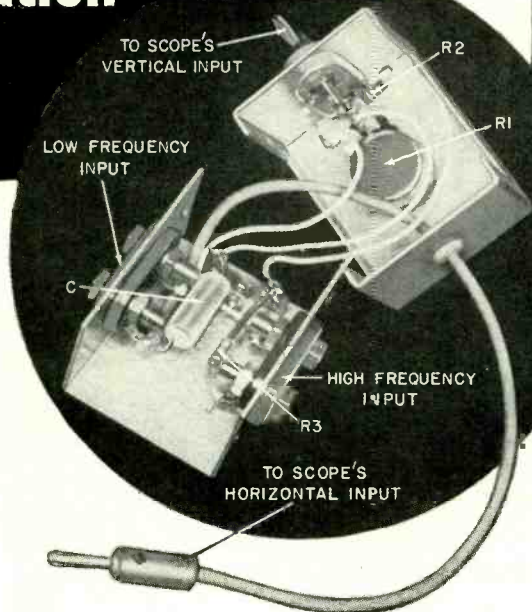

Parts layout inside comparator.

Fig. 2—Circular trace is obtained with comparator connected to a scope.

By J. E. PUGH, JR.

**F**REQUENCY comparison by the circular-trace method is very simple and permits accurate comparison of higher frequency ratios than possible with the conventional Lissajous-figure method.

In the circular-trace method, the lower frequency is used to generate a circle or ellipse on the oscilloscope by applying it to the horizontal and vertical amplifiers through an appropriate

phase shifter. The higher frequency is applied to the vertical amplifier and appears as a modulation on the circle. Because the trace is circular, the forward and return portions of the pattern do not overlap as with Lissajous figures. Confusion is eliminated and comparison of very high frequency ratios is possible.

Although the higher and lower (reference and unknown) frequencies are interchangeable as connected to the phase shifter, a more easily read oscilloscope pattern is obtained when the lower frequency is used to generate the circular trace. In most scopes the gain and high-frequency response of the horizontal amplifier are less than those of the vertical amplifier so the lower frequency is applied directly to the horizontal amplifier.

The phase shifter can also be used for measuring percentage of modulation of both carrier and modulation frequencies.

### Comparator circuit

The comparator is easy to build and operate. It can simplify frequency comparison—such as oscillator calibration—immensely. It is designed to permit direct connection to the oscilloscope. The basic phase shifter consists of C

and R1 (Fig. 1) while resistors R2 and R3 isolate the higher-frequency generator from the lower-frequency generator and horizontal amplifier. Potentiometer R1 permits adjustment of the lower frequency's phase, as applied to the vertical amplifier. This allows the shape of the circular trace to be adjusted for best readability. C and R1 supply a usable phase shift from 20 cycles to about 1 mc. The low-frequency shift can be improved by increasing C to 0.1  $\mu$ f—but at the expense of a smaller shift at the high-frequency end.

A 1 $\frac{1}{2}$  x 2 $\frac{1}{8}$  x 2 $\frac{3}{4}$ -inch aluminum box houses the circuit. The layout is not critical, but clearance between parts must be watched as space is limited.

A double banana plug permits direct connection to the vertical amplifier terminals of the oscilloscope, and a single banana plug on a flexible lead connects to the horizontal amplifier. Both the reference and unknown frequencies are connected to the circuit through double banana plugs and jacks.

The double banana plug for connecting to the vertical amplifier is mounted on one end of the case. (To match the vertical input of your scope another type of connector may be needed. Just replace the double banana plug with a connector to match your scope.—*Editor*) It is made from a double binding-post insulator and two banana plugs with threaded mounting studs. The

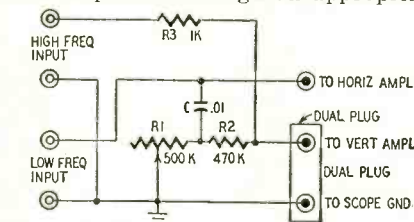

- R1—pot, 500,000 ohms
- R2—470,000 ohms, 1/2 watt
- R3—1,000 ohms, 1/2 watt
- C—.01  $\mu$ f, 200 volts
- Banana plugs, double, Millen 37212 (2)
- Banana jacks, double, National FWJ (2)
- Banana plugs, single, 3/4-inch stud, Johnson 108-75A (2)
- Banana plug, insulated, single, red
- Insulator, binding-post mount, double, National FWC
- Bar knob, 1/4 inches for 1/4-inch shaft
- Bakelite tie point, 2 terminals
- Aluminum case, 1 $\frac{1}{2}$  x 2 $\frac{1}{8}$  x 2 $\frac{3}{4}$  inches, Fleximount
- Red test prod wire, 0.140-inch diameter (10 feet)
- Black test prod wire, 0.140-inch diameter (10 feet)
- Insulated sleeve, 1/4 inch OD x 3/8 inch long
- Miscellaneous hardware

Fig. 1—Circuit of phase-shift comparator.

**TRIO**<sup>®</sup>

# Color Antennas

*Specifically designed for color*

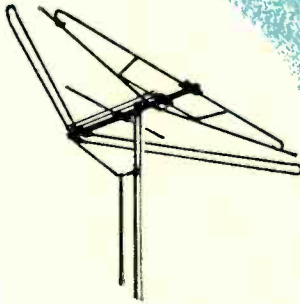

## **TRIO**<sup>®</sup> **COLORITE**

*recommended for both color and black and white reception in areas formerly using conical and conical-yagi installations*

*small and compact for easier installation and improved outside appearance.*

*flat frequency response a necessity for good color reception*

U.S. PATENT No. 2,772,413  
CANADIAN PATENT No. 541,670

## **magna** **chrome** element system

The Magni-Chrome element system consists of an EXTENDED WING DIPOLE accurately coupled with a precision V-dipole. This combination is designed to magnify the chroma characteristics of the incoming color signal to assure true, full-color reception. The folded dipole is V-d at the exact

angle that gives greatest gain and band width when used in conjunction with the EXTENDED WING DIPOLE. Extremely flat frequency response across the entire VHF band is obtained together with improved gain.

*for the ultimate in color reception*

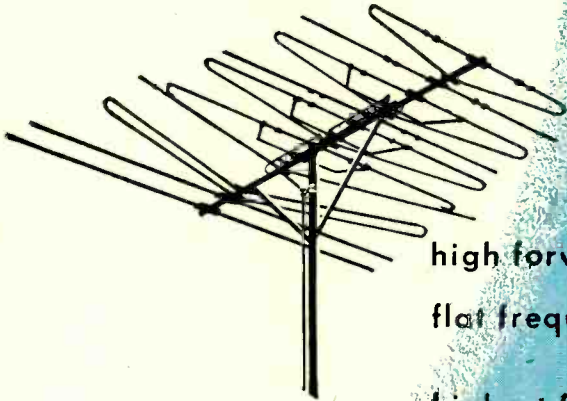

## **TRIO**<sup>®</sup> **COLOR-ROYAL**

*high forward gain Sharper, Clearer Pictures High Signal-to-Noise Ratio*

*flat frequency response Improved Contrast on Black & White - Perfect Reproduction of the Color Signal*

*highest front-to-back ratio For Freedom From Co-channel Interference*

### **tri-stop reflectors**

*Used in combination with the "Wing" and Collinear directors give exceptionally high front to back ratio while maintaining optimum gain on all channels.*

**THE LINE WITH PROTECTION**



Export Sales Div., Scheel International Inc., 5909 N. Lincoln Ave., Chicago, U.S.A. Cable Address: MARSHEEL

COPYRIGHT 1957 TRIO MFG. CO.

## TEST INSTRUMENTS

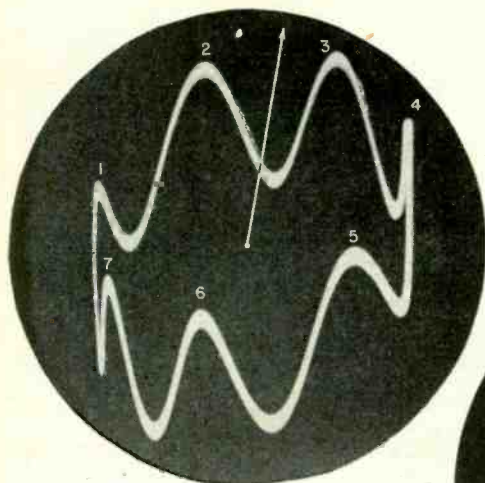

Fig. 3—Oscilloscope trace showing a frequency ratio of 7:1.

threaded studs are smaller in diameter than the holes in the insulator and a ¼-inch-diameter ¾-inch-long sleeve is used to provide a good fit. The sleeve can be metal or fiber. The assembled plug is inserted in one of the double jacks before tightening the nuts to align the plugs correctly.

After construction is completed the individual plugs and jacks can be labeled with decals. The hot terminal of each plug and jack should be marked with a dab of red paint since they are not polarized.

### How to use it

First insert the double banana plug of the comparator into the scope's vertical input terminals. Connect the single plug to the horizontal amplifier jack. If the reference frequency is the lower one—such as the 60-cycle power-line frequency or a variable low-frequency generator—connect it to the lower-frequency terminals.

Now attach the unknown-frequency generator to the higher-frequency terminals and reduce its output to zero. With the scope's sweep-selector switch set on external, adjust the comparator's phase control to give a circular sweep as illustrated in Fig. 2. The horizontal and vertical gain controls are adjusted to give a suitable size to the circle. Increase the output of the unknown-frequency generator until the circle is well modulated but avoid overlapping the upper and lower portions of the trace. See Figs. 3, 4, and 5 for this pattern.

Adjust the reference frequency until a stationary pattern is obtained and count the number of cycles on the circle. This is most easily done by counting the number of peaks—positive or negative. Then determine the number of lines cut by a radial line through the circle. This is shown in Fig. 4. The frequency ratio is now determined by:  $\text{Ratio} = \frac{\text{number of cycles (+ or - peaks)}}{\text{number of lines cut}}$

Fig. 5—This scope trace shows frequency ratio of 17:1.

Fig. 4—Pattern seen with 7:2 frequency ratio.

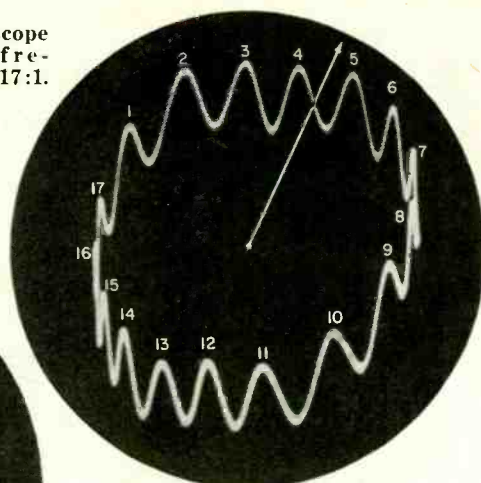
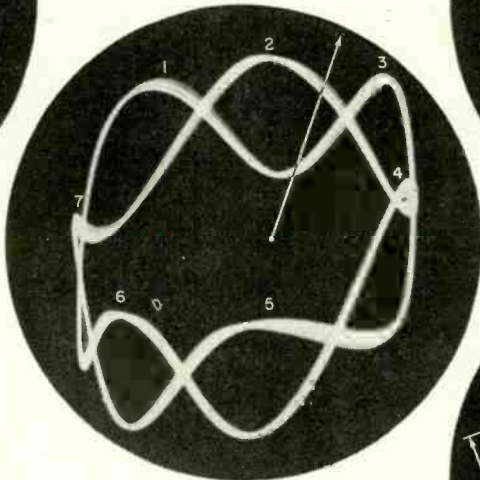

Fig. 7—Method of measuring percent of modulation from oscilloscope pattern.

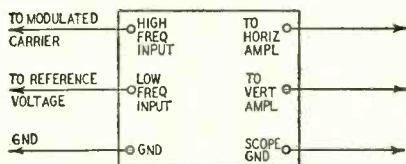
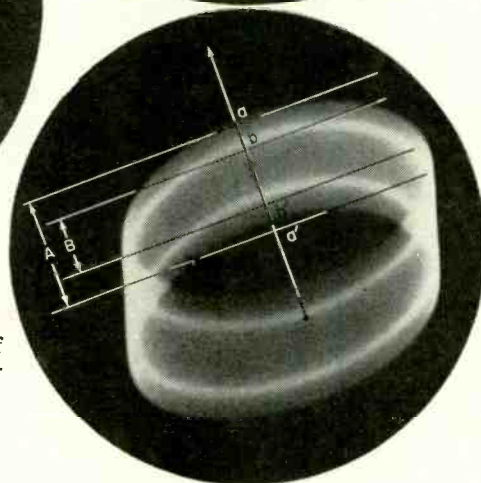

Fig. 6—Using comparator to measure percent of modulation.

In Fig. 3 the ratio is 7/1, in Fig. 4 it is 7/2 and in Fig. 5 it is 17/1.

When comparing frequencies over a wide range—when calibrating an audio signal generator with a 60-cycle reference frequency—it is not necessary to count cycles at each multiple of the reference frequency. Simply check the ratio at one of the lower multiples and add the reference frequency each time a stationary pattern with complete cycles (Figs. 3 and 5) is obtained.

For example, 60 would be added each time a stationary pattern of full cycles is obtained if the reference frequency is 60 cycles. An occasional count should be made to be sure that a multiple hasn't been missed.

It is possible to compare frequencies up to several megacycles. The upper limit is determined only by the frequency response of the oscilloscope amplifiers.

The percentage of modulation can be obtained by using a reference frequency much lower than the carrier frequency but higher than the modula-

tion frequency. Connections to the comparator are shown in Fig. 6. This will give a pattern as shown in Fig. 7. This makes possible a very simple percent-of-modulation measurement without requiring a connection to the modulation voltage.

By connecting the modulated carrier to the high-frequency terminal and the modulation voltage to the low-frequency terminal a pattern similar to the familiar trapezoid is obtained.

In either case the voltages will have to be about the same amplitude as when making modulation measurements using conventional methods.

In Fig. 7 the percent of modulation is 30 and is obtained by:

$$\% \text{ modulation} = \frac{A - B}{A + B} \times 100.$$

When the reference frequency is equal to or less than the modulation frequency, the area between a and b will appear as a number of alternations. The shape of these alternations will depend on the shapes of the reference and modulation voltages and the number of cycles on their frequency ratio.

If the reference frequency is increased until it nears the carrier frequency, waves extending the entire width of the ring (from a to a') will begin to appear. The number of complete cycles will indicate the carrier to reference frequency ratio. END



# Use Delco Radio Service Parts!

2N278—Highest power transistor used in auto radios.

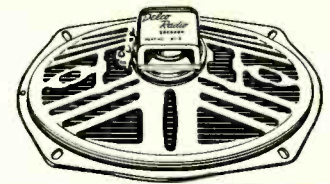

SPEAKERS



IRON CORES



RESISTORS



CAPACITORS

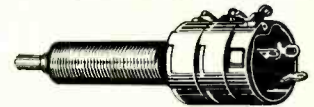

CONTROLS



TUBES

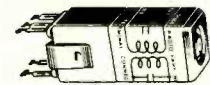

COILS



VIBRATORS

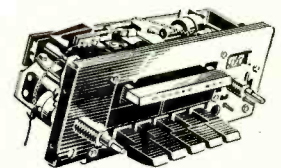

TUNER PARTS

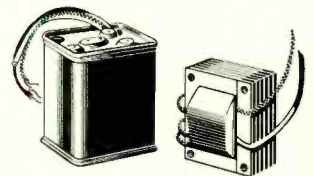

TRANSFORMERS

*Your Delco Radio Electronic Parts Distributor carries the complete line, giving you fast, dependable service on the items you'll need for Delco Radio—and other radio—service work. Delco Radio also provides:*

- Wide selection of special application parts
- Complete technical training program
- Effective warranty program
- Dealer identification signs

Get the facts today on this truly profitable dealer setup, and grow with General Motors!

Available everywhere through Electronic Distributors associated with ...



## DELCO RADIO

DIVISION OF GENERAL MOTORS, KOKOMO, INDIANA

... another  
**MALLORY**  
 service-engineered  
 product

*Months under Water...*



prove  
**MALLORY**  
 "GEMS"

*moisture proof*

To demonstrate how well Mallory "Gem" tubular capacitors resist moisture, we put some in plastic tubes filled with water. Months later, their internal resistance remains unchanged . . . proving there has been no moisture absorption.

Sure, you don't expect to submerge the capacitors you install. But when you're looking for top performance, even under the toughest humidity—always ask for Mallory "Gems."

Get your stock today from your Mallory distributor. He carries them in all popular ratings for by-pass and coupling applications.

P. R. MALLORY & CO. Inc.  
**MALLORY**

P. R. MALLORY & CO. Inc., INDIANAPOLIS 6, INDIANA

- Capacitors
- Vibrators
- Resistors
- Power Supplies
- Mercury and Zinc-Carbon Batteries
- Controls
- Switches
- Rectifiers
- Filters

new  
**Records**



Note: Records below are 12-inch LP and play back with RIAA curve unless otherwise indicated.

**IBERT: Divertissement**  
**FRANCAIS: Symphony for Strings**  
 Surinach conducting  
 MGM String and Chamber Orchestra  
 MGM E-3514

The recent Boston Pops recording of the *Divertissement*, which I liked very much, is a full-scale orchestral transcription. This is the original scoring for a smaller chamber orchestra and the effect is possibly even more amusing. The greater intimacy of the smaller group and the excellent presence produce a fine effect in the living room. The Francais symphony is a seldom-heard work which most listeners should find interesting, pleasant and restful. The string bass on both sides is outstanding. Some pickups may be slightly overdriven on the peaks.

**COBERT/LANG: Frankie and Johnny**  
 Special cast and orchestra  
 MGM E-3499

This is another first performance of a dramatic musical but of a very different color. Based on the tale told in the classic jazz song *Frankie and Johnny*, it is billed as a legend in two acts. This presents the songs from the two acts as they had been performed on Broadway. I commend it to other companies as evidence that a Broadway type show can be recorded reasonably cleanly, with a minimum of overcutting, good tonal balance and fine sound.

**Calypto Jazz Sampler**  
 Cook XX-2

Another Cook sampler, this one with 14 selections from 9 of Cook's Caribbean albums, including at least one of all the various local types from pure calypso to steel band, recorded on the scene, pressed by Microfusion and packaged in sealed, flexible, transparent plastic cases. Typical Cook quality with tremendous presence and a wide variety of high, middle and bass, test and showoff material. The maracas high highs are especially impressive on equipment with a fine transient and high end response. The bass is live and different.

**Folk Music Festival (Songs and Dances of Kazakhstan, Kirghizia, Georgia and Moldavia)**  
 Various artists  
 Westminster WP-6055

Some 18 samples of folksongs of Russia in performances and recordings which are both rather amateur in quality but with on-the-very-spot authenticity. The master tapes are Russian and recorded (but clearly not by Emory Cook) in the various provinces with indigenous performers. As for the songs and dances, they should be of interest not only to the folksong specialists but to the ordinary listener as well and would enliven a hi-fi concert nicely. Most of them have an "I played fiddle for the Czar" pattern, but some resemble Spanish flamenca more than anything else and others have definitely Oriental elements.

**Bach on the Biggest**  
 Robert Elmore on Organ of Atlantic City Convention Hall  
 Mercury MG-50127

Bach buffs will be rebuffed by the very title and idea, but those who like their sound bigger and louder will find here a noteworthy experience, especially in big pedal bass and one of the longest reverberation periods on records. Actu-

## NEW RECORDS (Continued)

ally Elmore is not irreverent and the reverberation doesn't do mayhem to Bach. Mercury engineers deserve great credit since the proper placement of a mike or mikes must have presented a headache in keeping with the monumental size of both building and organ.

### **Fiesta for Pipe Organ** With Rhythm Accompaniment Alfred Mendez, Organist RCA Victor LPM-1444

And now mambos, cha-cha-chas and other Latin musical tid-bits on the organ with a rhythm backing—a combination that is possible only with the help of multiple miking and electronic reproduction. Anyhow, the combination of a fair pedal and sharp Latin style high highs is most individual and provides a unique hi-fi potpourri. Very clean and sharp.

### **Fingers on Fire** Arthur Smith and His Cracker-Jacks MGM E-3525

Arthur Smith is the hill-billy virtuoso of the Carolinas radio and TV stations who is billed as "the world's greatest guitar player" and here doubles on banjo, fiddle, mandolin and accordion in a dozen of his biggest hits, including *Listen to the Mocking Bird*, *Yes, Sir, That's My Baby*, *Chicken Strut*, *Freeze it Boogie*, etc. Before you contest the claim, you'll do well to listen to this. Notable hi-fi-wise for the very fine reproduction of the plucked instruments and the novel effects Arthur achieves, including clucking of chickens, chirping of birds, etc. And a far better recording than pop music usually receives.

### **A Night at Poppa John's** Poppa John Gordy, Piano with Various Backing RCA Victor LPM-1424

Here's more pop recorded cleanly and with high presence and notably sharp highs. Poppa plays ragtime with an infectious beat though not with the originality of Del Wood. Add this to the 1-foot shelf of really good pop recordings.

### **S. F. Record Tid-Bits** San Francisco M-33012

This is a sampler of this label's complete catalog, but it is also an excellent review of the evolution of popular music from the nineties to the present, plus a sampling of mechanical music-makers such as the old player pianos and cylinder phonographs. The recording technique is top-notch—in the audiophile class—and presents some brilliant hi-fi material with very sharp, clean highs and a notable drum in the Guckenheimer Band selection. The most unusual of all the samplers and sure to delight any hi-fi party. Warning: the selection from the Naughty Nineties really is: don't play this for the maiden aunt except with forethought.

### **Hi-Fi Sounds for Hounds** San Francisco M-33009

If you have a really first-class system, particularly a pickup and speakers with a superb high end and transient response, this will deliver realism that will shame two-channel stereo. The bass drum on band 3 of the first side is most real, the roller-coaster ride has a terrific assortment of astonishingly clean mid-frequency transients. Among other novelties are a jug band, a one-man band, the surf of the Pacific and the best-yet reproductions of a tremendous orchestrion type nickelodeon. Guaranteed to please on any system and positively astonish on the best.

### **The Orchestra** Stokowski Capitol SAL-8385

It is becoming more and more difficult to think of something original in the way of demonstration records, but Capitol has managed the trick in this, which presents a fine orchestra under Stokowski playing eight works—first, the several sections of the orchestra alone and then in various combinations. The percussion section, Section I of Farberman's *Evolution*, is particularly impressive, but the entire recording yields very impressive sound with excellent definition despite the use of a very live hall or studio. The recording is free of any audible distortion when the best pickups are used. Hi-fi fans will find

... another  
**MALLORY**  
service-engineered  
product



Stop  
tourin'  
the town  
for  
dual control  
replacements...

## get the NEW **MALLORY** Dual Controls

the newest and surest solution  
to an old service problem

Here's how you can put a stop to those time-consuming shopping tours and special orders... eliminate those "awaiting-parts" delays. Get Mallory dual control replacements... the newest and surest solution to the age-old servicing problem of where to find *exact* dual control replacements.

Your Mallory Distributor can assemble a custom-made dual concentric control, with or without a switch, in just 30 seconds... with the new Mallory components and technique. You'll get a control to meet original specifications... to service just about any make or model TV set, or home or auto radio. The finished part will be as rigid as a one-piece control... won't come apart in service.

P. R. MALLORY & CO. Inc.  
**MALLORY**

P. R. MALLORY & CO. Inc., INDIANAPOLIS 6, INDIANA

- Capacitors • Vibrators • Resistors • Controls • Switches • Filters
- Rectifiers • Power Supplies • Mercury and Zinc-Carbon Batteries

# Weller soldering guns make safe repairs to Heat-Sensitive Components

A WELLER Soldering Gun gives you precise control of heat. This feature is especially important when replacing heat-sensitive components. Here are some typical applications:



**1 REPAIRING PLASTIC-MOUNTED TRANSFORMERS.** Your Weller Gun gives you precise heat control for this delicate operation. Prevents melting of plastic sockets; enables you to repair loose contacts and hair-thin coil-winding wire without damage.

**2 SOLDERING VOICE COIL CONNECTIONS.** Heat-control characteristic of Weller Guns enables you to repair loose or broken voice coil connections on the reflecting surface of paper resonating cone. The slightest mishandling of a soldering iron would burn cone.



**3 REPLACING CRYSTAL OSCILLATOR.** Controlled heat is imperative for replacing crystal oscillator in color demodulator circuits. With a Weller Soldering Gun you get perfect heat control, thus avoid damage to delicate crystal element.



**4 REPAIRING REMOTE-CONTROL TUNING UNITS.** Your Weller Soldering Gun fits neatly into the small spaces between the terminal tabs on telephone-type relay stacks. Also, heat shut-off feature of gun prevents damage to insulation.



There are professional model *Weller* guns  
for every type of service work



Your choice of models . . . ranging from 100 to 250 watts single heat and 100 to 275 dual heat types. Suitable for every kind of service operation. All models heat in 5 seconds; provide instant, triggermatic control of temperature.

ORDER FROM YOUR ELECTRONIC PARTS DISTRIBUTOR

*Weller* ELECTRIC CORP.  
601 Stone's Crossing Road, Easton, Pa.

## NEW RECORDS (Continued)

this both instructive and very impressive on good systems. But the *Gates of Kiev* is not nearly as spectacular as its Toscanini recording (RCA Victor LM-1838, Moussorgsky's *Pictures at an Exhibition*).

### TCHAIKOVSKY: *Symphony No. 4* Scherchen conducting Vienna State Opera Orchestra

Westminster XWN-18522

I know of no symphony better suited for hi-fi demonstration than this with its brassy peaks, procession of instruments in solo passages, excellent drums and tremendous dynamic range. And both Scherchen and Westminster do it complete justice in this recording which presents both the crescendos and diminuendos with great clarity and cleanness. The balance is especially good and even at moderate volume it yields a fine illusion of actual performance. The recording, on the dead side, yields superior definition and yet, played back in a fair-sized living room, it delivers a just-right liveness. An outstanding example of modern high-fidelity recording with no exaggeration but a high degree of verisimilitude.

### Munch Conducts Wagner Boston Symphony Orchestra

RCA Victor LM-2119

Another sampling of Wagner's music in orchestral suites—*Overture and Venusberg* from *Tannhauser*, *Magic Fire Music*, and *Siegfried's Rhine Journey*—in a suitably spirited performance by this superb orchestra whose choirs are as true as chords on a well-tuned piano. The recording is up to the very high quality so usual in RCA's discs of this orchestra, and extremely clean even in the very big peaks. Plenty of brass, high highs, good bass and fair percussion for splendid showoff—especially the middle of the first side.

### IBERT: *Capriccio* *Divertissement* *Suite Elizabethaine* Winterthur and Vienna Symphonies

Westminster XWN-18520

*The Divertissement* is deservedly popular for its satiric humor; the other two are less often played and in a more serious vein. Together they give a good review of Ibert's range of styles, which can go from baroque to jazz. The recording is especially fine with excellent definition and is perfectly clean.

### Band Music of HM Irish Guard Band RCA Victor LM-2020

A fine variety of 14 concert pieces ranging from the *Irish Washerwoman* to *The Dance of the Tumblers*—many of which are in the repertoire of our best high-school bands—brilliantly played by the band of Her Majesty's Irish Guards. High-school band leaders should have a copy by all means, but the ordinary hi-fi listener will enjoy it, too. One of the very best brass-band recordings with excellent balance, a high degree of presence and good drum in spots.

### Hi-Fi à La Espanola Fennel conducting Eastman-Rochester Pops Orchestra

Mercury MG-50144

Ten Spanish classics from *Andalusia* and *Malaguena* to *Goyescas* and *The Ritual Fire Dance* from *The Three Cornered Hat* recorded with a very Olympian sound. The drums, especially, will delight everybody but particularly owners of big speaker systems. There are plenty of Latin high highs to try the tweeters, and the dynamic range will try everything from pickups to speakers. Should become very popular as a demonstration and showoff record, for few records deliver both ends as spectacularly.

### SCHUBERT: *Octet in F Major* Vienna Concerthaus Quartet plus Winds and Double Bass

Westminster XWN-18471

I have often remarked how much more real a chamber group sounds in the typical living room than does a big orchestra. Here is another very notable case in point. This is a quartet augmented by a double bass, clarinet, bassoon

**NEW RECORDS (Continued)**

and French horn in a superb example of octet music. The definition, purity of tone and cleanliness of this recording can produce an illusion of presence so complete that the difference would be mere quibbling. The biggest difference is in the low level of the double bass.

**CHAIKIN: Concerto for Accordion**  
**SHASHAKOV: Concerto for Balalaika**  
**GORODOVSKAYA:**  
*Suite for Folk Orchestra*  
**VITOLYN: Village Polka**  
**Various Russian Orchestras**  
Westminster XWN-18464

Those who like samplings of strange and novel instruments and different music should get hold of this—one of the best recordings from a sound quality viewpoint to come from the USSR, though not up to Westminster's own best. The accordion concerto is the more classical both in composition and orchestration; the others are definitely folksy in character. All of it is pleasant and obviously Russian.

**KENNAN: Three Pieces for Orchestra**  
**BERGSMA:**  
*Gold and the Senor Commandante*  
**BERNARD ROGERS:**  
*Once Upon a Time*  
Hanson conducting Eastman-Rochester Orchestra

Mercury MG-50147

Three examples of programmatic music by three contemporary Americans in the spectacular Olympian recording technique with lots of tremendous drums and bass, but likely to overload even the finest pickups in the peaks. The music is not likely to be remembered long, but is not unpleasant. *Once Upon a Time* has a real charm, as well as some fine high percussives and a final movement with big, low-down drums galore.

**BACH: Sonata No. 2**  
*Partita No. 3*  
Jascha Heifetz . . .

RCA Victor LM-2115

Two of the most remarkable—and difficult—works for the violin in magnificent performances by one of the greatest virtuosos, recorded close up to reveal to a knowing ear the technique of fingering and with one of the cleanest and loveliest violin tones on records. I can think of no finer present for a violin student who also owns a good hi-fi, but anyone who loves the fiddle should be extremely pleased with it.

**Curtain Going Up**  
Fiedler and Boston Pops

RCA Victor LM-2093

Pleasant orchestral potpourri of the principal tunes from six recent Broadway shows: *My Fair Lady*, *Carousel*, *Brigadoon*, *South Pacific*, *Wonderful Town* and *Can-Can*, plus a medley of Rogers waltzes. Not remarkable from a hi-fi point of view but clean and bright and free of the overcut distortion most show recordings are guilty of.

**BEETHOVEN:**  
*"Emperor" Piano Concerto (No. 5)*  
Solomon, pianist  
Menges conducting Philharmonia Orchestra

RCA Victor LM-2108

**Horowitz in Recital**  
Selections from Public Performances

RCA Victor LM-1957

**BEETHOVEN:**  
*Piano Sonata No. 17 (Tempest)*

**CHOPIN: Etudes 1, 5 and 8**  
*Mazurka in A*  
*Scherzo in C Sharp Minor*  
Dorothy Eustis

Alta Records 1001

About as useful a measure of very fine hi-fi systems as I know of is the reproduction of various pianos. The piano still remains the most difficult single instrument to record and reproduce faithfully, for it takes a superb combina-

# Burroughs

is creating

# New Careers

in the field  
of the future

# Data Processing for Defense

**Burroughs  
Continues  
To Grow!**

Complementing Burroughs' recognized leadership in the commercial research, development and manufacture of machines for business, is the sound expansion of the Military Field Service Division

## TECHNICIANS

Here's How  
You Can

## ADVANCE

to

## ENGINEERING STATUS

As a successful applicant you will attend a 22-week formalized training program in Philadelphia, Pa., leading to nation-wide field assignments as a digital computer specialist. You will receive full salary during the entire training program. Generous benefits including educational assistance (in addition to above training).

**New Classes Are  
Being Formed Monthly**

If you have technical institute or military training in electronics (preferably combined with pulse circuitry) you are invited to address your inquiry to:

**MR. ROBERT LEVINSON**  
Employment Manager  
Dept. M789-B



# Burroughs Corporation

Military Field Service Division

511 NORTH BROAD ST. PHILADELPHIA 23, PA

**"The Foremost Name In Computation"**

# HANDLE THE TOUGH SERVICE JOBS

AS SLICK AS YOU DO THE EASY ONES...

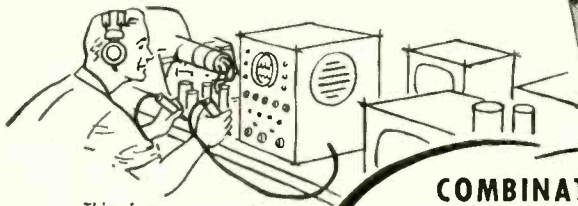

This famous Ghirardi Service Library shows you how to

**HANDLE ANY JOB EASIER, BETTER and lots faster**

**COMBINATION OFFER**  
**SAVE \$1.25**  
 Almost 1500 pages of modern service training for only \$13.00  
**3 MONTHS TO PAY**

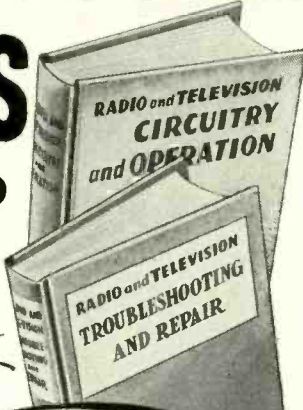

These two giant how-to-do-it Ghirardi manuals make it easy for you to be an expert on all types of Radio-TV receiver service... at only a fraction of the price you might expect to pay. From tough realignment jobs to tracking down "intermittents"... from analyzing response curves to "static" and "dynamic" test procedures, these books explain every step clearly as A-B-C. They point out time-saving short cuts and help you work better, more profitably! Use coupon. Practice from them 10 days AT OUR RISK!

## 1 COMPLETE Professional TRAINING IN MODERN SERVICE METHODS

Radio and Television TROUBLESHOOTING AND REPAIR gets right down to earth in guiding you through each service procedure... from locating troubles quickly to fixing them fast and right.

For beginners, this famous 822-page book is an absolutely complete training course in professional methods. For experienced servicemen, it is the ideal way to develop better troubleshooting methods and shortcuts, to find quick answers to puzzling problems and to handle tough jobs faster.

Block diagrams, oscilloscope patterns, response curves and other features speed your work... make each step doubly clear. Handy troubleshooting

charts cover practically every type of job from troubleshooting television to AM and FM realignment. IF and Detector sections, car radios and many more.

Here are a few of the subjects covered in Radio and TV Troubleshooting and Repair: Component Troubles; Basic Troubleshooting Methods; Short-cuts, Tips and Ideas; Complete Guide to TV Service; Realignment Made Easy; FM, Communications Receivers, Record Players, etc.; Auto Radios; Loudspeakers; Tuner and Switching Mechanisms; and dozens more. 417 clear illustrations. Price only \$7.50 separately. See MONEY-SAVING OFFER in coupon.

## 2 Learn all about circuits... AND WATCH SERVICE HEADACHES DISAPPEAR!

You can repair any radio or TV set... even special electronic equipment far better and faster when you know all about its circuits! That's where this 669-page Radio & TV CIRCUITRY AND OPERATION is worth its weight in gold.

You locate troubles in far less time... because circuitry "know-how" teaches you exactly what to look for and where. You make repairs better and faster... because you eliminate useless testing and guesswork.

Radio & TV CIRCUITRY AND OPERATION deals fully with practically every circuit and circuit variation used in modern receivers. It teaches you their peculiarities and likely trouble spots. Over 110-pages

explain Television... from scanning to signal to every circuit detail of each of the receiver sections.

Includes: AM... FM... R-F Amplifiers and TRF... AM Superhets... AM Detector and AVC Systems... A-F Amplifiers... Speakers... Power Supplies... Television... Antenna Systems... Pickups and Record Players... Changers... Mechanical Construction of Receivers... and lots more.

Throughout, this great book equips you with the kind of above-average service training that really pays off! Price only \$6.75... or see MONEY-SAVING OFFER in coupon.

### --- PRACTICE 10 DAYS FREE! ---

Dept. RE-117, RINEHART AND COMPANY, Inc., 232 Madison Ave., NEW YORK 16, N. Y.  
 Send books checked for 10-DAY FREE EXAMINATION. In 10 days, I will either remit price indicated (plus postage) or return books postpaid and owe you nothing. (NOTE: Send cash with order and we pay postage. Same 10-day return privilege with money promptly refunded.)

**MONEY-SAVING COMBINATION**

Both books only \$13.00... you save \$1.25. Payable at rate of \$4 (plus postage) after 10 days, and \$3 a month thereafter until \$13.00 has been paid.

- Radio & TV Troubleshooting and Repair (\$7.50)  
 Radio & TV Circuitry and Operation (\$6.75)

Name.....

Address.....

City, Zone, State.....

OUTSIDE U.S.A.—\$8.00 for TROUBLESHOOTING AND REPAIR; \$7.25 for CIRCUITRY AND OPERATION; \$14.00 for both. Cash with order only. Money refunded if you return books in 10 days.

### NEW RECORDS (Continued)

tion of transient response, dynamic range and freedom from wow and hangover to do an adequate job. Furthermore, both pianos themselves and the technique of playing them are so highly individual that no two pianos sound exactly alike, even when played by the same person. Hence, system quality can be judged by the degree to which the differences are revealed: the better the recording and system, the more distinct each piano recording.

Here are three cases in point. The Horowitz, which is a collection of recordings made over several years, is especially good for the purpose, presenting a variety of piano tones and recording quality (some of it quite poor). It provides, also, a fine sampling of the technique of an acknowledged modern virtuoso. Horowitz playing *The Stars and Stripes Forever* alone is worth the price.

*The Emperor* is one of the greatest of piano concerti and receives here a recording brilliant in sound and quite representative of today's piano recording technique.

The Dorothy Eustis on a new label represents a successful attempt to do better by the piano than the ordinary disc manages to do. Recorded at a lower average level and without limiters, it is very clean, though one or two peaks may overdrive some pickups. Given a turntable without much wow, the piano is very true and sharp. The pressing is by the Microfusion process.

**Fritz Kreisler Favorites**  
 Rafael Druian, violin

Mercury MG-50119

A baker's dozen of Kreisler compositions, including *Caprice Viennoise*, *Old Refrain*, *Liebesleid*, *Tambourine Chinois* and six of the famous "hoax" pieces he ascribed to 18th and 19th century masters. I suppose many would prefer to have actual Kreisler performances, but Druian, concertmeister of the Minneapolis Symphony, performs them with faithful sentimentality and a beautiful fiddle tone free of edginess except in one or two peaks where some pickups may be overdriven or tweeters found wanting.

**SURINACH: Concerto for Piano, Strings and Cymbals**

MARGA RICHTER: *Concerto for Piano, Violas, Cellos and Basses*

William Masselos, Piano  
 Surinach conducting MGM-String Orchestra

MGM E-3547

Both of these works are scarcely two years old. The Surinach is engagingly unusual both for its odd instrumentation and its combination of modern and Spanish feelings; it shouldn't take much musical sophistication to like it and the sound is very different. The piano is very fine and the cymbals deliver a surprising variety of effects. MGM has commendably held back its tendency to overcut on the Surinach side, but the Richter side will present trouble to many pickups, especially when the piano hits fff. It will not be easy to take except to those who like the modern idiom.

### Last Call for Crazy Otto

About two years ago Germany exported some Polydor discs called *Die Beschwipste Drahtkommode*, featuring as the artist *Der Schrage Otto*, who played a very schmaltzy ragtime piano with a rhythm backing. These laid the disc jockeys on their ears and for a while you will recall the air was full of Crazy Otto. There was a good reason for this, the recording was terrific, with high highs so sharp that they shamed our own 45-rpm pops and gave a real opportunity for AM and FM stations to show off their new hi-fi pickups. Later they were issued by an American label on 33 rpm. Now Radio Shack of Boston is disposing of the remainders of the original Polydors (three for \$1) and I strongly recommend that the set be added to the library for demonstration as well as pleasure. They may also be available on other record bargain counters. There are three of them under the above title and Polydor numbers: 22,009, 22,041 and 22,253. END

Name and address of any manufacturer of records mentioned in this column may be obtained by writing Records, RADIO-ELECTRONICS, 154 West 14 St., New York 11, N.Y.



# new Devices



**PDC METERS.** Kits for constructing a large number of meters from a few foundation movements. Contain 6, 12 or 60 meter movements, related scale faces and companion resistors. Combining, meter movements with scale faces and resistors



lets 6-movement kit (illustrated) make up almost 100 meters (dc voltmeters, micro- and milliammeters; ac voltmeters and milliammeters). 12-movement kit turns out more than 400 meters. 60-movement kit replaces stock of 2,000 meters.—**Precise Development Corp.**, 2 Neil Court, Oceanside, N. Y.

**TUBE TESTER, model 302.** Checks for shorts, leakage and

quality. Line-voltage regulation. With *PTA* adapter, checks and rejuvenates picture tubes.—**Electronic Measurements Corp.**, 625 Broadway, New York 13, N.Y.

**IMPEDANCE BRIDGE KIT, model 1B-2A.** Built-in power supply, 1,000-cycle generator and vacuum-tube detector. 100



—0-100- $\mu$ a meter for null indications. Measures resistance from 0.1 ohm-10 megohms, capacitance from 10  $\mu$ f-100  $\mu$ f, inductance from 10 mh-100 h; dissipation factor from .002-1; Q from 0.1-1,000.—**Heath Co.**, 305 Territorial Rd., Benton Harbor, Mich.

**TRANSISTOR TESTER, model TT-2.** Checks current gain, leakage, opens, shorts and cutoff current of all transistors. Checks diodes for forward-reverse cur-

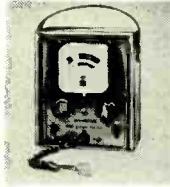

rent gain.—**Century Electronics Co. Inc.**, 111 Roosevelt Ave., Mineola, N. Y.

**VOLTAGE DROPPER, model RP-612.** Provides 6 volts from a

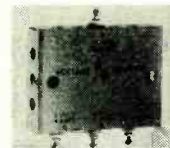

12-volt battery source. 4, 6 and 8-amp taps.  $4\frac{1}{2} \times 3\frac{1}{2} \times 1$  inch.—**Rue Products**, 1628 Venice Blvd., Venice, Calif.

**TOROID COILS**, for high-frequency applications. *MQD series.* Temperature-stabilized from  $-40^{\circ}\text{C}$  to  $85^{\circ}\text{C}$ . 6 types ranging from 2-20 mh. Q of 170 at 50,000 cycles. Hermetically



sealed.—**United Transformer Corp.**, 150 Varick St., New York 13, N. Y.

**HIGH-FREQUENCY CHOKES.** 4 ferrite-bead units. From 0.3-



1.3  $\mu$ h with 30-mc ac resistance of 25-100 ohms. For use as filament chokes, parasitic suppressors and series elements of low-pass filters for frequencies of 5-200 mc.—**National Co. Inc.**, 61 Sherman St., Malden 48, Mass.

**RF CHOKES. RL-100, RL-101, RL-102, RL-110, RL-111 and RL-112.** Medium- and high-power units in 3 mounting types. For frequencies 3.5-31 and 12-55 mc.

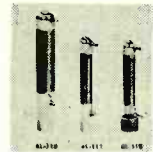

**Raypar Inc.**, 7800 W. Addison St., Chicago 34, Ill.

**CHOPPER INPUT TRANSFORMERS.** Operate with signal levels of 0.1  $\mu$ v with maximum transfer efficiency. Primaries

## Now! Mr. Dealer... PHILCO Fidelitape

Philco Fidelitape will bring new customers into your store. Tape recorders are now in wide use and recording tape is one of the fastest growing businesses in America today. Make sure you get your share!

- Unequaled in uniformity of output. Guaranteed not to exceed  $\pm \frac{1}{4}$  db within the reel and  $\pm \frac{1}{2}$  db from reel to reel.
- Guaranteed splice-free. Continuous output uniformity and freedom from distortion. Excellent response at high and low frequencies.
- Has a drier-type formula which prevents oxide rub off. Low surface friction reduces wear on heads.
- Has exceptionally low background noise through better dispersing of finer oxide particles. These oxides are magnetically oriented to provide increased output and reduced distortion.
- Has special anti-tack agent which eliminates possibility of sticking on hot erase and record heads.
- Has a moisture-repellent binder which assures smooth, quiet tape travel even under hot, humid conditions.

MAIL THIS COUPON OR CALL YOUR LOCAL PHILCO DISTRIBUTOR FOR FURTHER INFORMATION.

**PHILCO**  
*Accessory Division*

WORLD'S LARGEST DISTRIBUTOR OF

- Service Parts • Accessories • Universal Components
- Power Packed Batteries • Long Life Tubes • Heavy Duty Rotors • Star Bright 20/20 Picture Tubes
- Long Distance Antennas

PHILCO CORPORATION  
"A" STREET AND ALLEGHENY AVE.  
PHILADELPHIA 34, PA.

Please send me further information on the brand new, exciting PHILCO Fidelitape

Name \_\_\_\_\_  
Address \_\_\_\_\_  
City \_\_\_\_\_ Zone \_\_\_\_\_ State \_\_\_\_\_

RE-1157A



- Extra strength in 1½-MIL Cellulose Acetate.  
7" reel—1200 ft. . . . 5" reel—600 ft.
- Extra length in 1-MIL Cellulose Acetate . . . 50% more tape on standard reel.  
7" reel—1800 ft. . . . 5" reel—900 ft.
- Extra length and extra strength in 1-MIL Mylar\* . . . Polyester Film.  
7" reel—1800 ft. . . . 5" reel—900 ft.

\*DU FONT TRADEMARK

This is KRAEUTER'S

# LITTLE NIPPER

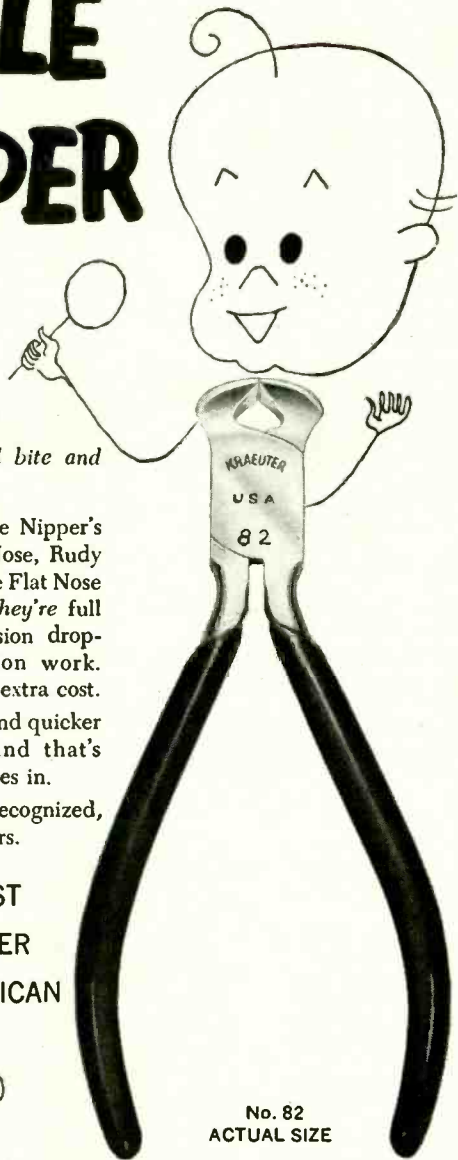

Only 4½" — but all bite and precision.

And below are Little Nipper's pals—Larry Long Nose, Rudy Round Nose, Frankie Flat Nose and Slick Cutter. They're full of fight, too. Precision drop-forged for precision work. Cushion grips at no extra cost.

The job goes easier and quicker with fine tools. And that's where Kraeuter comes in.

Sold only through recognized, legitimate distributors.

BUY THE FINEST

BUY KRAEUTER

BUY AMERICAN

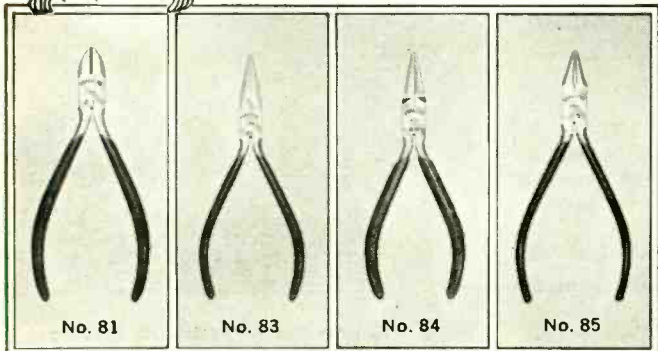

No. 82  
ACTUAL SIZE

AS MODERN AS TOMORROW

**kraeuter & co., inc**

FOR 100 YEARS THE FINEST IN HAND TOOLS 1860-1960 • NEWARK, N. J.



## NEW DEVICES (Continued)

for use with either dc chopper-modulated or ac signals. Sealed in high-permeability shielded cans. — James Vibrapowr Co., 4050 N. Rockwell St., Chicago 18, Ill.

**IF TRANSFORMERS.** Three sizes: ¼, ½ and ¾ inch. Printed-circuit (illustrated) and wired-circuit types. Built-in

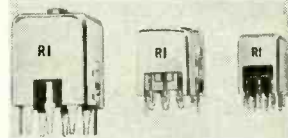

shunt capacitors from 64–470 µf. — Radio Industries Inc., 5225 N. Ravenswood Ave., Chicago 40, Ill.

**MINIATURE TRANSFORMERS, Teenyformers.** 0.203 x 0.297 inch. 700 weigh less than a pound. For transistor applications. — Gramer-Halldorson Transformer Corp., 2734 N. Pulaski Rd., Chicago 39, Ill.

**FLYBACK REPLACEMENTS.** EFR 196 replaces Motorola 24K736488. ERF 197 replaces



Motorola 24C736487. Packed in hermetically sealed plastic containers. — Rogers Electronic Corp., 49 Bleecker St., New York 12, N. Y.

**CONSTANT-VOLTAGE TRANSFORMERS,** 5 models. Regulate 6.3-volt filament supply within 1% with line-voltage variations up to 15%. Regula-



tion automatic. Response time within 1.5 cycles. Current ratings of 5–25 amperes. — Sola Electric Co., 4633 W. 16 St., Chicago 50, Ill.

**REPLACEMENT UNITS.** TV power transformers: P-3064 replaces G-E RTP-314; P-2847 Motorola 25C790864 and 25K791977; P-2876 RCA 77635 and P-3134 Zenith 95-1298. Filament transformers: P-2864 replaces Philco 32-8574-1; P-2848 Motorola 25B791793 and 25B700137 and P-2889 replaces Crosley 155532. Rf chokes: BC-551, 2.5 mh; BC-552, 5.0 mh, and BC-553, 10 mh. — Merit Coil & Transformer Corp., 4427 N. Clark St., Chicago 40, Ill.

**OUTPUT TRANSFORMER, model S-19Z.** Primary, 10,000 ohms, ct; secondary, 3.2 ohms.

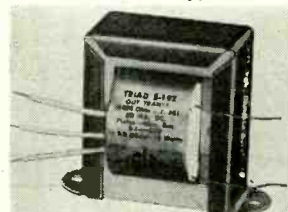

Unit rated at 10 watts. — Triad Transformer Corp., 4055 Redwood Ave., Venice, Calif.

**VIBRATORS, Gold Label line.** Quiet operation. Buttonless con-



tact construction. — P. R. Mallory & Co. Inc., 34 S. Gray St., Indianapolis, Ind.

**PRECISION RESISTORS, Rite-ohm series 77.** Metal film type. Axial or radial leads. 100–300,000 ohms, ¼ watt. — Ohmite Manufacturing Co., 3661 Howard St., Skokie, Ill.

**CAPACITOR KITS, ceramics.** CK-2 contains 150 most-needed disc ceramics in 2-drawer cabinet. CK-3 has 75 most-needed

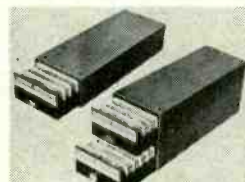

disc ceramics in 1-drawer cabinet. CK-4 offers 3 each of 4 different Universal ceramic capacitors mounted on a heavy card folder. — Sprague Products Co., 125 Marshall St., N. Adams, Mass.

**CAPACITOR, type RQL.** Mylar metallized in a hermetically sealed case. Reliable at temper-



atures up to 125° without derating. — Astron Corp., 225 Grant St., E. Newark, N. J.

**ELECTROLYTIC CAPACITORS, Tan-O-Mite, series TF.** High-quality tantalum-foil units manufactured in limited quan-



ties. 0.25–140 µf. Voltages up to 150. — Ohmite Manufacturing Co., 3653 Howard Ave., Skokie, Ill.

**SUBMINIATURE ELECTROLYTICS, type EE (Epoxy end fill) and type EM (spun end**



with rubber bushing). Voltage ratings of 1, 3, 6, 8, 16, 26 and 30. Size from 3/16 x ½ to ¼ x ¾ inches. — Astron Corp., 255 Grant Ave., E. Newark, N. J.

**CAPACITORS, type 600-UE.** Mylar dielectric, molded in Epon. High humidity resist-





# HICKOK

# FIRST

## Basically **NEW** Development in Tube Tester Design in over 25 Years

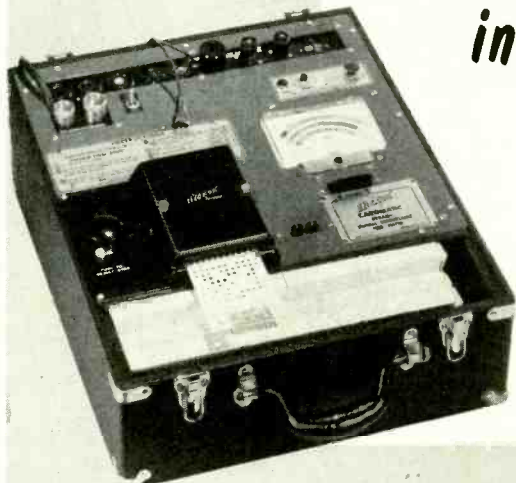

MODEL  
**123A**

**1** Shorts-Leakage



**2** Quality Value



**3** Gas Content

**8-Second  
HIGH-SPEED Test**

(after tube warm-up)

Automatic and by far the Fastest, but . . . the real news is the Greatly Improved Circuit of this equipment which is the first important New Tube Tester Design in the past 25 years.

**300% MORE ACCURATE:** Tests Gm to an accuracy of 1% (Most portable Gm testers attain 5% accuracy or less. Emission type testers cannot test for Gm and therefore have very poor performance in detecting weak tubes.)

**SCREEN and PLATE VOLTAGES:** 12 to 160 volts  
This wide selection of voltages protects against obsolescence. For instance, new car radios use 12 volt plate voltage.

**FILAMENT VOLTAGES:** 0.1 to 119.9 volts in 1/10 volt steps  
More and more tubes are now in use with odd filament voltages. The 123A will accurately test all of them at their exact filament voltage.

**200 MA LOAD ON RECTIFIER TUBES:**  
This gives an accurate test of the operation of a rectifier tube under load.

**NEW KNEE TEST:**  
This new test evaluates the ability of a tube to perform in TV horizontal or vertical output circuits. As a tube gets older it loses its ability to deliver current which results in non-linearity of raster, (crowding of the raster where one side pulls away, etc.). The 123A tests this "Knee" point to determine whether the tube will cause trouble in a TV set.

**TESTS SHORTS and LEAKAGE TO 20 MEGOHMS**  
(Users have detected as high as 50 megohms leakage.)

**EXTRA SENSITIVE GAS TEST and Grid Emission Test**  
Here is what a CARDMATIC user said, "My 123A paid for itself in 2 months simply by weeding out weak tubes in four kinds of TV circuits—Horizontal Output, Damper, Rectifier, I.F. This is in addition to time saved me in hit-or-miss tube substitution or hunting for other troubles when the tube was actually at fault. Another said, "My wife tests all the radio-TV tubes in my shop. She says the 123A saves her so much time she absolutely will not give it up."

Ask your jobber for a free demonstration of  
the 123A CARDMATIC  
in your shop.

Free technical booklet is available.

Write to . . .

**THE HICKOK ELECTRICAL INSTRUMENT CO.**

10531 Dupont Ave., Cleveland 8, Ohio

*This equipment includes the  
New Hickok  
Service-Instruction Warranty*

NEW DEVICES (Continued)

ance, high stability and low leakage. — Good-All Electric Manufacturing Co., Ogallala, Neb.

**HI-FI SOUND SYSTEM, Audio-tone.** Incorporates 5-watt amplifier with frequency response



of 60-12,000 cycles. 8-inch woofer and 3-inch tweeter with crossover network. — Audio-Master Corp., 17 E. 45 St., New York, N. Y.

**HI-FI RECORD CHANGER, GS-77.** Automatic and manual operation at 4 speeds. Intermixes and plays all sizes of records at any selected speed,



and automatically intermixes and plays 33- and 45-rpm records without regard to sequence. 5-second change cycle. 4-pole hum-shielded motor. — Glaser-Steers Corp., 2 Main St., Belleville, N. J.

**AUDIO EQUIPMENT,** transistorized *TM series*. *TM-4* (illustrated) and *TM-2*, remote and studio mixer amplifiers. Fre-



quency response:  $\pm 1$  db, 60-17,000 cycles. Gain: 20 db, 30-db optional. 50-600-ohm input, 50- and 600-ohm outputs. Temperature-stabilized circuitry. — Dunlap Electronics Inc., 764 Ninth St., Des Moines, Iowa.

**FINAL AMPLIFIER, H.C.A. single channel.** For large hotel or apartment distribution systems. 6-mc bandwidth. 5-volt maximum output. Built-in power supply. Covers channels 2-13. Maximum gain, 20 db. Input

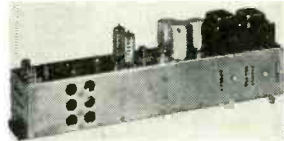

and output impedances, 75 ohms. — Benco Television Associates Ltd., 27 Taber Rd., Rexdale, Ontario, Canada.

**TAPE RECORDER,** magazine repeater. Pentron *model A-4*. Recorder-playback unit for con-



tinuous or intermittent sales messages or personalized announcements of 1-55 minutes in length. — Morhan Exporting Co., 458 Broadway, New York 13, N. Y.

**TAPE-RECORDER MICROPHONE, model TRC.** Dynamic



and ceramic types. Push-to-talk control with locking position.  $4\frac{3}{4}$  inches long,  $1\frac{1}{4}$ -inch diameter. — Elgin National Watch Co., Elgin, Ill.

**MICROPHONES,** general-purpose *Commando series*. *Model 420* lavalier type worn around the neck. *Models 415 and 430* (illustrated). For tape record-



ing, PA systems, etc. — Shure Brothers Inc., 246 Hartrey Ave., Evanston, Ill.

**TONE ARM,** high-fidelity Micro-Balanced with two sealed viscous-damped pivots for horizontal and vertical movement. Stylus force adjustable from 0 to 15 grams. Single-hole

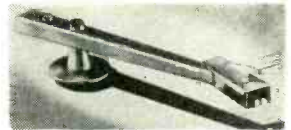

mounting. — Gray Manufacturing Co., Arbor St., Hartford, Conn.

**FM-AM TUNER, model 2520.** FM tuning with or without afc. Sensitivity: 20  $\mu$ v for 20 db of quieting. Logging scale. Inputs: 72 and 300 ohms. FM frequency response: 20-20,000 cycles; AM:



20-5,000 cycles. — Bell Sound Systems Inc., 555 Marion Rd., Columbus 7, Ohio.

**SPEAKER SYSTEM, SFB/3.** Ready-to-play 3-way system. 12-, 10- and 3-inch speakers. Two styles: *Warwick* (illustrated) and *Windsor*. Walnut, mahogany or blond finish. — British

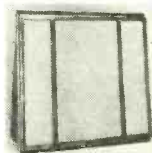

Industries Corp., 80 Shore Rd., Port Washington, N. Y.

**CERAMIC CARTRIDGES, 5 series.** Two models: *5T* (illustrated) turnover cartridge for 78- and 45-33-rpm records; and



*You'll be delighted!*

with EMC's New Test Equipment . . . in advance design and precision construction features found only in higher priced instruments. It pays to save more and service better with the complete EMC line.

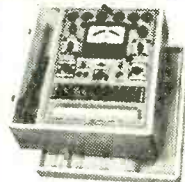

**NEW! EMC Model 206P**  
Dynamic Mutual  
Conductance  
Tube Tester

The lowest priced mutual conductance tube checker on market. Checks tubes for microhm value and gas content. Completely flexible switching. Your best buy in a quality tube tester.

Hand Rubbed  
Carrying Case ..... \$83.50



**NEW!**  
EMC Model 108  
Handi Tester

The only appliance and auto battery tester in its price class to use a D'Arsonval, instead of an iron vane type meter. You get exclusive advantages of maximum accuracy, maximum scale length, and minimum battery replacement cost . . . yet, pay no more than for competitive makes.

Comes complete with test leads and instruction manual.  
Wired ..... \$15.95  
In Kit Form ..... \$12.95



**NEW!**  
EMC Model 905-6A  
Battery Eliminator,  
Charger, and  
Vibrator Checker

A MUST for auto radio service. Features continuously variable voltage output — in either 6 or 12 volt operation. Checks all 6 or 12 volt vibrators.

Wired ..... \$67.90  
In Kit Form ..... \$44.90

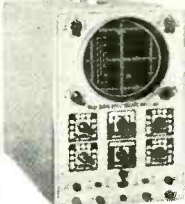

**NEW! EMC Model 601**  
Wide Band Oscilloscope  
For Color And Mono-  
chrome TV

Exclusive features: full 5 mc band-width for color TV servicing — push-pull vertical amplifier, .02 volt per inch sensitivity — 5 U P I — 5" scope tube — 60 cycle phasing control — DC positioning controls eliminates overshooting and bounce — built-in peak to peak calibration reference — 2-step compensated attenuator input — multi-vibrator sweep, from 15 cycles to over 75 kilocycles. \$117.90, wired and tested.



**NEW! EMC Model 301**  
Speedi Tube Tester

Precision crafted for checking tubes in seconds. Only 2 settings to make. Checks for shorts, leakages, and quality. Over 375 tubes now listed, including 0Z4 tube. New listings available. Checks and rejuvenates picture tubes with Model PTA, Picture Tube Adaptor (only \$4.50).

Model 301P (illustrated), with  $4\frac{1}{2}$ " plastic front meter in oak carrying case, \$47.50; Kit, \$33.20.

Yes, I want to see for myself, send me **RE-11**  
**FREE** — a detailed catalog of the COMPLETE  
EMC LINE OF PRECISION TEST EQUIPMENT.

NAME \_\_\_\_\_  
STREET \_\_\_\_\_  
CITY \_\_\_\_\_ STATE \_\_\_\_\_

**EMC** ELECTRONIC  
MEASUREMENTS  
CORPORATION  
625 Broadway, New York 12, N. Y.  
Export Dept. — 370 Broadway, New York 13, N. Y.

NEW DEVICES (Continued)



5P single-needle model for either 78- or 45-33-rpm speeds. Both have sapphire needles.—**Sonotone Corp.**, Saw Mill River Rd., P. O. Box 200, Elmsford, N. Y.

**REAR-SEAT SPEAKER, Car-Fi II**, for convertibles and sport cars. 2½ x 10-inch speaker. Silicene-treated cone. Mounts



on back of front seat. Molded plastic case.—**Empire Electronics Inc.**, 22022 Woodward Ave., Ferndale 20, Mich.

**SPEAKER, model 217**. Same specifications as previous speakers produced by this manufacturer but using a chemically



treated cone (polymerized). Clearer, flatter response with absence of resonance is ob-

tained.—**Hartley Products Co.**, 521 E. 162 St., New York 51, N. Y.

**SPEAKER SYSTEM, Monte Carlo**. Includes six moving coil speakers, two 12-inch and four 3-inch units. 4-ohm impedance. Handles 30 watts continuously



and 60-watt peaks. Frequency range: 25 - 20,000 cycles.—**Weathers Industries**, 66 E. Gloucester Pike, Barrington, N. J.

**TRANSMITTER-EXCITER, Viking Navigator**. 40 watts CW. Pi-network output matches 40-600-ohm transmission line impedance. Bandswitching from 160 through 10 meters. Internal vfo



or crystal control. Kit or wired.—**E. F. Johnson Co.**, Waseca, Minn.

**VHF RECEIVERS**. Each model has 8 tubes plus rectifier. Power supply for 115-volt ac operation and loudspeaker are built-in. Tunable units available in



ranges: 30-50-mc FM, 112-132-mc AM, 132-154-mc AM and 154-174-mc FM. Crystal controlled fixed-frequency models also manufactured.—**Gonset, Div. of L. A. Young Spring & Wire Corp.**, 801 S. Main St., Burbank, Calif.

**BROADCAST TUNER, model R**

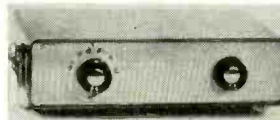

909 B.C. Designed to work with marine radiotelephone units. Provide broadcast entertainment while still maintaining monitor service on marine frequencies.—**Kaar Engineering Corp.**, 2995 Middlefield Rd., Palo Alto, Calif.

**TRANSISTOR RADIO, XR-2**. Reflex circuit with diode detector. Operates on 3 penlight cells. Lightweight earpiece.—



**I. D. E. A., Regency Div.**, 7900 Pendleton Pike, Indianapolis, Ind.

**ANTENNA MOUNTS**, 15 new models. 2 adjustable wall mounts (illustrated), universal swivel-base mount, ground mount, swivel roof mount and

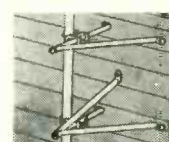

3 adjustable eave mounts, 2 wall mounts, snap-in wall mount and 4 tubular wall mounts.—**Channel Master Corp.**, Ellenville, N. Y.

**ANTENNA TUNER, Globe Matcher Jr., model AT-3**. For transmitters with power input of 100 watts or less. Provides second-harmonic attenuation. Unbalanced output. *Globe Match-*



*er, Sr., model AT-4*. Handles up to 600 watts rf input. Has built-in VSWR bridge. Class-B and -C linear amplifier, *model LA-1*. Maximum plate power input 200 watts when operated AM class-B linear, 300 watts dc input or 420 P-E-P input as class-B linear SSB or DSB. Requires 15 watts

Get This Valuable Book

FREE

Just For Examining COYNE'S New Set

"Applied Practical Radio-Television"

on 7 DAY FREE TRIAL!

NOW!

7 BIG BOOKS

IN ONE GREAT SET!

**SEND NO MONEY!** Just mail coupon for 7-volume set on 7 days free trial. We'll include book of 150 TV-Radio Patterns & Diagrams. If you keep the set, pay \$2 in 7 days and \$2 per month until \$24.50 plus postage is paid. (Cash price, only \$22.95). Or you can return the library at our expense in 7 days and owe nothing. **YOU BE THE JUDGE.** Either way, the book of TV-Radio Patterns is yours **FREE** to keep! Offer is limited. Act NOW!

FREE BOOK—FREE TRIAL COUPON!

**Educational Book Publishing Division**  
**COYNE ELECTRICAL SCHOOL, Dept. B7-T1**  
 500 S. Paulina St., Chicago 12, Ill.

**YES!** Send 7-Volume "Applied Practical Radio-Television" for 7 days **FREE TRIAL** per your offer. Include TV-Radio Patterns & Diagram Book **FREE**.

Name..... Age.....

Address.....

City..... Zone..... State.....

Where Employed.....

Check here if you want library sent C.O.D. You pay postman \$22.95 plus C.O.D. postage on delivery. 7-day money-back guarantee.

Educational Book Publishing Division

COYNE

ELECTRICAL SCHOOL

500 S. Paulina St., Dept. B7-T1, Chicago 12, Ill.



### Receiver R-1/ARR-1—\$1.95

A two-stage RF superhet converter in range of 234-258 Mc. Ideal for conversion to various preselectors, ham 250 Mc. converter, or other uses. Uses 1—834 acorn tubes supplied. In compact aluminum case 10" x 3 1/2" x 3". Filaments operate from 12 or 24 V., by merely throwing switch contained in unit. Complete with conversion article as in Jan. 1949 "Radio-TV News." Brand new demilitarized units (input coil insulation broken—easily repaired). Ship wt. 4 lbs. Price \$1.95 ea. 12 or 24 V. co-axial antenna relay for above or other mobile transmitter-receiver equip. New.....\$1.25 ea.

### "HUNTERS & SPORTS HEATERS"

#### Kerosene or Gasoline Heater Reduced to \$4.95

Brand new. Evans blue flame heater. Output approx. 50,000 BTU. Ideal for garage or shack where not confined. Size: 10" dia. x 12" high. Cost Govt. many times our low price. Shipped in original packing. wt. 47 lbs. Price \$4.95



### HURU-28A GENERATOR—\$79.50

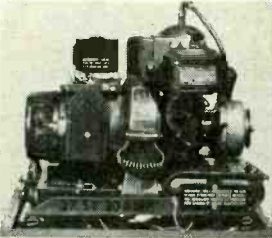

Homelite gasoline generator 28.5 V. DC at 2 K.W. 3100 RPM motor speed. Electric or rope start. Use to power surplus aircraft radio equipment, cabin or marine power, aircraft starting, etc. These units rebuilt like new by the U.S. Air Force and have not been run since. Size 21 1/2" x 24 5/8" x 17 1/4". Wt. 115 lbs. Original AF boxed. Guaranteed. Ship. wt. 210 lbs. "Instruction book included."

### BRAND NEW DYNAMOTORS

Type	Input Volts DC	Output Volts	Output A.	Ship. Wt. lbs.	Price
DM-42	12 V.	515 and 1030	.260	30	\$12.95
DM 40	12 V.	172	.138	7 1/2	2.75
PE-94B	28 V.	150-300	.260	50	3.95
DM-34	12 V.	220	.080	7	used 1.75
DM-36	24 V.	220	.080	7	2.75
DM-45A	24 V.	255	.050	5	2.25
D-104	27 V.	285	.060	5	2.25

#### Inverters:

Type 12119-1B Remote Compass 12 V. DC Input 24 V. 400 cy. output. Ship. wt. 5 lbs. New.....\$4.95 ea. Class A 24 V. DC input—125 V. 400 cycle 100 VA. Single phase 1/0 PF output. Size 6" x 4 1/2" x 8 1/2". Ship. wt. 14 lbs. New.....\$7.50 ea.

### GOLF CAR MOTOR—\$4.50

New 134 HP. battery operated motor for building up your golf car or other use. Operates from 12 to 24 V. with speed to 6000 RPM. Measures 4 1/8" dia. x 9" long. 5/8" shaft. Wt. 1 1/2 lbs. Ship. wt. 13 lbs.

### 954 ACORN TUBES—\$5 ea.

Cartons of 200 brand new. Individually boxed surplus RCA 954 acorn tubes. With a list price of over \$800. Yours for \$10 carton. (No broken cartons sold.)

### TS-9 HANDSET—\$1.99



### PARTS KITS: \$2.99 ea.

Many of these kits may be purchased for less than any single item alone. Convenience of having parts at hand saves you time and money. All new useful parts. No duds. All popular brand name. Your word-of-mouth advertising makes our business. Satisfaction Guaranteed or money refunded.

#### C. KIT MIDGET VARIABLES

Includes 10 ass'd. variables such as 100 mmfd. BUD MC1265 31 plate (reg. net \$2.45), 243 mmfd. dual 33 mmfd. also 3, 15, 35, 50 and 100 mmfd. All midline types. Ship. wt. 3 lbs.

#### D. KIT PAPER TUBULAR CONDENSERS

50 popular sizes including plastic and metal encased from .001 mfd. to 1 mfd. 600 V. and cathode by pass types. Popular brands, no freak types or sizes. Ship. wt. 3 lbs.

#### E. KIT TUBE SOCKETS

829, 832, Stantite, XU-4 Pin. Acorn, miniature, octal, locat. wafer, and molded types. A whale of a buy. 50 in all. Ship. wt. 3 lbs.

#### F. KIT RADIO KNOBS 100

100 various knobs for radio & television. Push on, set screw, pointer, audio, red, brown, black and white. All for reg. 1/4" shaft. Ship. wt. 3 lbs.

#### G. KIT WAFER SWITCHES

25 assorted bakelite and stantite insulated single & multi-gang types for band change and other circuits. Ship. wt. 4 lbs.

#### H. KIT RHEOSTATS & POTENTIOMETERS

25 assorted replacement, regular & midget types. Ship. wt. 4 lbs.

#### I. KIT MOUNTING HARDWARE

100 pcs. various terminal strips of screw & solder types. Ship. wt. 3 lbs.

#### J. KIT COILS

50 pcs. Contains RCA TV IF's, Onc. HV. osc. RF choke, antenna, & RF coils. Ship. wt. 3 lbs.

#### K. KIT INSULATORS

50 pcs. Includes aircraft strain, antenna, feed thru, stand off, and mounting types. All low loss. Ship. wt. 6 lbs.

### 30 AMP. BATTERY CHARGER WHILE SUPPLY LASTS—\$12.50 ea.

Cost Government \$300 ea. Our purchase of large quantity allows this bargain. War Rel. Control Mfrd. Type ED 33510. Charging rates up to 30 amps. on 12-30 volt battery combinations (6-15 cells). Operates from 110 V. C. Size 20" wide x 20" high x 10" deep. Shipped in original overseas pack with spares and cord. Wt. 65 lbs. Ship. wt. 145 lbs.

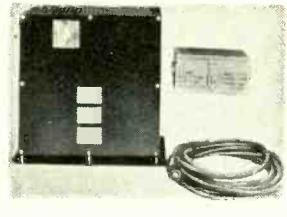

### New Torque Amplifier Only \$9.75

FOR USE WITH SYNCHROS SIZE 5, 6, 7

Provide torque amplification and ease in rotation of input shaft. Rotating power applied to input shaft is reproduced in any direction on the output shaft. Torque supplied entirely by a 140 HP 110 V AC motor through gear and planetary drive hookup. Speed varies directly with rotation of input shaft with noticeable loss of accuracy. Motor requires capacitor of 85-120 mfd. for starting. Designed for use on gun control devices and cost the Govt. hundreds of dollars to mfr. In cast aluminum case. Size: 12" h. x 5 3/8" w. x 7 1/2" d. Wgt. 23 lbs. Packed in original wood box. Shipp. wt. 45 lbs. Brand New.....\$9.95 Starting capacitor for above Torque Amplifier. New.....\$1.00

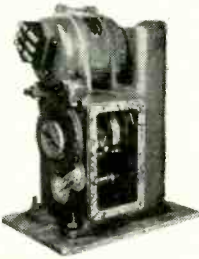

### OAV-1 TEST SIGNAL GENERATOR, \$12.50 ea.

This signal generator was used to provide a test signal of constant frequency for operation and alignment of AF and amplifier stages in the CG-46 ACQ type receivers. The generator covers the range between 10-250 megacycles. Amplitude modulated square wave output is obtained at frequencies of .1, 1, 10 and 100 kc. depending on the position of the freq. mod. pulse switch. A 15 Mc. signal is also provided by a second osc. stage. Power is supplied by internal 115 V. 60 cycle AC supply connected to source by cord provided. Brand new with instruction book. Ship. wt. 62 lbs. Price.....\$12.50 ea.

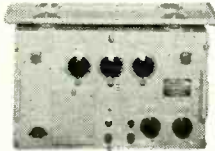

### BC-604 Transmitter—\$9.95 ea.

30 watt crystal controlled on 10 preselected channels in range of 20-27.9 Mc. F3 emission. Operates from 12 V. or 24 V. DC (dynamotor not supplied). Tubes and meter supplied worth the price of entire unit. Size 18" x 10" x 12". Excellent to new condition. Ship. wt. approx. 100 lbs. ea. Price \$9.95 each. Receiver and Transmitter combination \$25.00 set. Order a receiver and transmitter combination for mobile or fixed station or for wireless intercom.



### Metal Locators—\$39.50

The famous SCR-625 mine detector which has been found to be unexcelled for locating hidden metallic objects such as pipes, treasure, etc. Hundreds in use by prospectors, mining companies, plumbers, veneer mills, etc. Comes complete in carrying case and checked ready for operation with addition of batteries below. Case size 28 1/4" x 19" x 8 1/2". Operating carrying wt. approx. 15 lbs. Ship. wt. 55 lbs. Price \$39.50 ea. Batteries for above SCR-625 \$4.25 set.



### M-1 Odograph, over \$5,000 value—\$89.50

See Nov. 1944 Electronics for Full Description

This is a survey instrument for automatically drawing a map of the terrain over which the jeep or other vehicle to which it is attached traverses. These instruments mfrd. currently by Monroe Calculating Machine Co. and sold in excess of \$5,000. Our surplus purchase allows passing on these machines at this value. Order early. Only 200 in stock. Units have been rebuilt by Corp of Engineers, U.S. Army and guaranteed road condition. Ideal for prospectors, oil companies, power line and farm use. Nothing else needed for operation except vehicle. Many are using the compass unit for automatic pilots on boats—many applications. A real machine. Ship. wt. approx. 300 lbs. Our Price \$89.50 ea.



### Freq. Crystals... Less Than 5c Ea.

Imagine crystals costing Govt. \$3.50 to \$12.50 ea. In this assortment, 100 brand new; various freqs.; plenty in hand. Practically all types of holders; all mounted; guaranteed to oscillate. Assortment of 100. Ship. wt. 4 lbs. \$4.95

### RC-58-B FACSIMILE SET—\$59.50 ea.

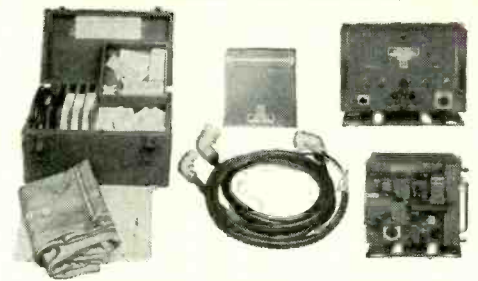

Brand new, complete, ready to operate by connecting to 12 V. DC source. Spare parts included with ample supply of ink and paper. Transmits and receives and prints, signatures and copy. Ideal for loan offices, banks or other businesses where signatures must be verified, etc. Use two sets together with 2 wire telephone line or radio carrier between. Cost Govt. approx. \$6000. Your price, in original packing, only \$59.50 ea. Ship. wt. approx 300 lbs.

### SYNCHROS, SELSYNS, AUTOSYNS!!! At money-saving prices!!! LARGE QUANTITY 20,000 in stock 110 v. 60 cycle Units

Navy Size & Type	Approx. Weight (lbs.)	Approx. Length (Inches)	Approx. Diameter (Inches)	Price Used
SF	5	6.0-6.8	3.4-3.6	\$5.00
SG	5	6.0-6.8	3.4-3.6	5.00
SDG	5	6.0-6.8	3.4-3.6	5.00
SGT	5	6.0-6.8	3.4-3.6	5.00
GG	5	6.4-7.5	5.8	3.50
7G	18	8.9-9.2	5.8	10.00
7DG	18	8.9-9.2	5.8	10.00

Size & Type	Approx. Weight (lbs.)	Approx. Length (Inches)	Approx. Diameter (Inches)	Price Used
SF	5	6.0-6.8	3.4-3.6	\$3.50
SG	5	6.0-6.8	3.4-3.6	3.50
SDG	5	6.0-6.8	3.4-3.6	3.50

CT—Control Transformer; D—Differential Motor; DG—Differential Generator; F—Motor (Follower); G—Generator; Mfg. by Bendix, Ford Instrument Co. and General Electric. Specify: Bendix, Ford & GE in stock

### LEEDS & NORTHRUP MICROMAX RECORDERS

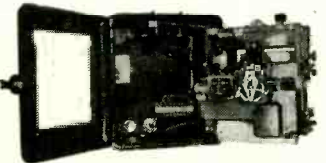

Strip type recorder used for controlling and recording wide variety of processes. Used originally for temp. range of 350-550° C. but may be changed for other applications. Operates on Wheatstone bridge principle using AC galvanometer movement. Original cost several times our low price. Removed from demilitarized equipment which in many cases was new. Sold as used but guaranteed, or money back if not satisfied. Ship. wt. approx. 165 lbs. \$179.50 ea.

### D-2 Auxiliary Power Plant Engines

Fairchild 10 h.p. at 3200 r.p.m., magneto shielded ignition, two cylinder, air-cooled type. Made to drive P-1, R-2 and NEA-3 type generators. Automatic altitude control for use to 40,000 feet. Use this engine to drive generators for welders or other uses where light weight quality engine is required. Guaranteed like new condition. Shipping weight 125 lbs. each.

Price \$85 each

24v. 200 amp. generator for above

\$1950 each.

Shipping weight 50 lbs. each.

# ESSE RADIO CO. 42 WEST SOUTH ST. INDIANAPOLIS 25, IND.

REMIT SHIPPING CHARGE AND INSTRUCTIONS WITH ALL ORDERS. OTHERWISE ORDER WILL BE SHIPPED EXPRESS COLLECT. ALL ITEMS GUARANTEED TO YOUR SATISFACTION OR MONEY REFUNDED IF RETURNED PREPAID WITHIN 10 DAYS OF RECEIPT

**NEW DEVICES (Continued)**

rf driving power. Up to 200 watts class-C CW with 18 watts drive. All units available kit or wired.—WRL Electronics, 34th & Broadway, Council Bluffs, Iowa.

**UNIVERSAL STRAP STAND-OFF, IMP.** Accommodates Nos. 8 and 9 standard wood-screw

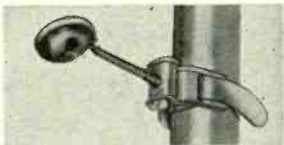

eyes. Zinc-coated steel buckle with galvanized or stainless-steel strap.—JFD Manufacturing Co., 6101 16th Ave., Brooklyn 4, N. Y.

**TELEVISION ANTENNA, Golden Topliner.** Anodized gold-color elements. 4 models. Single

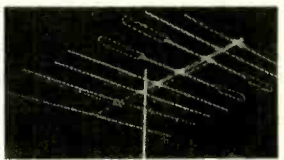

or stacked arrays, depending on required gain. G2540, G2550, G2560 and G2570.—Technical Appliance Corp., Sherburne, N. Y.

**TRIO COLOR ROYAL**, an all-channel color TV antenna. High forward gain and high signal-

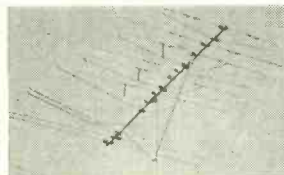

to-noise ratio. Flat frequency response over the vhf band.—Trio Manufacturing Co., Griggsville, Ill.

**ALL-TRANSISTOR AMPLIFIER.** 20 watts. For PA sys-

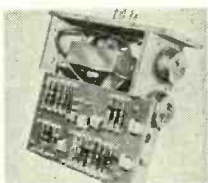

tems. Plugs in .50-20,000 cycles. Includes peak clipping and gain control.—Universal Transistor Products Corp., 143 E. 49 St., New York 17, N. Y.

**CABINET RACKS**, heavy duty. Removable rear door. Panel mounting rails integral part of sides. Accommodates standard 19-inch panels.—Bud Radio Inc., 2118 E. 55 St., Cleveland 3, Ohio.

**MAGNETIC SHIELDS.** Fit 7- and 9-pin vacuum-tube socket assemblies with bayonet type flange. Shielding material insensitive to shock and may be worked or transported without affecting its magnetic shielding qualities. Does not retain residual magnetism or require pe-

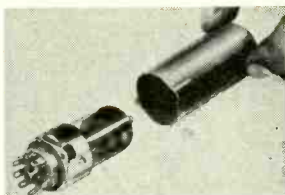

riodic annealing.—Perfection Mica Co., Magnetic Shield Div., 1322 N. Elston Ave., Chicago 22, Ill.

**CONNECTORS, Q Quick-Disconnect series.** 3 sizes with 3 shells: QO2, square flange receptacle; QH25, hermetically sealed round-flange receptacle and QO6, straight plug.—Canon Electric Co., P. O. Box 3765, Terminal Annex, Los Angeles 54, Calif.

**PHONO PLUGS AND JACKS** molded to extension cable. Straight and right-angle types. Shielded handle.—Switchcraft

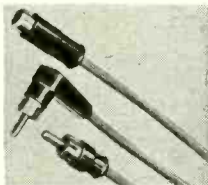

Inc., 1328 N. Halsted St., Chicago 22, Ill.

**FILM-COATED WIRE, Beldsol.** Solders without stripping. Coated with Polyurethane film. AIEE Class-A 105°C. For transformers, motor armatures, field coils, radio and TV universal coils, etc.—Belden Manufacturing Co., 4647 Van Buren St., Chicago 80, Ill.

**PRINTED-CIRCUIT BASE, Fluorply-F Laminite.** High bond strength of copper foil to plastic base. High dielectric strength. Readily cold-punched, drilled or machined.—International Resistance Co., 401 N. Broad St., Philadelphia 8, Pa.

**TUBE CADDY, model TC-5.** More than 3,300-cubic-inch vol-

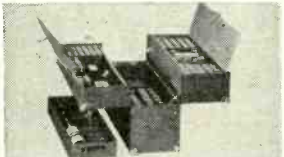

ume. Removable tool tray. 24 x 16½ x 8½ inches.—Argos Products Co., Genoa, Ill.

**GARAGE-DOOR OPENER**, remote-controlled Genie Lift-A-Dor. Cannot be accidentally triggered. Requires no FCC

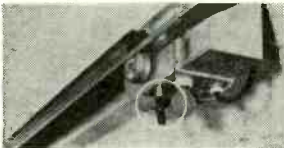

license. Unlocks, opens, lights, closes and locks overhead garage doors. Limited-range low-frequency principle.—Alliance Manufacturing Co. Inc., Lake Park Blvd., Alliance, Ohio. END

All specifications given on these pages are from manufacturers' data.

**LEARN MORE! EARN MORE!**  
WITH H. G. CISIN'S TV SERVICE BOOKS

**New! Guide To BASIC ELECTRICITY**



Learn electricity at home this easy way, without time-wasting correspondence. Information you need and want is at your finger-tips, clearly explained and illustrated. First two vol's just off press.

Send for these two new books at once—we guarantee you will be more than satisfied.

Vol. 1 (No. E1).....50c  
Vol. 2 (No. E2).....50c

**TV TUBE LOCATORS Vol's 1 & 2**

**TROUBLE INDICATING TUBE LOCATION GUIDES** for thousands of TV models from Admiral to Zenith. Tell which tubes to replace to cure every trouble due to tube defects.



Vol. 1 covers 1947 to 1953 models. Vol. 2, just off press, covers 1954 to 1957 sets including newest portables.

Vol. 1 (No. K1).....\$1  
Vol. 2 (No. K2).....\$1.50

**ABC of COLOR TV**



This easily understood new book takes the mystery out of Color TV.

Fully illustrated. Covers basic color principles, color transmission and reception, the color signal, color tubes. Helps you cash in on this profitable new field.

No. R1.....\$1

**RAPID TV TROUBLE SHOOTING METHOD**

New Edition

Novel TV servicing method enables a novice to diagnose TV troubles as rapidly as an expert.

Pix, raster and sound troubles are listed and given code numbers. When combined they tell exact location of trouble.



No. T1.....\$1

**TV CONSULTANT**



The TV serviceman's silent partner. New rapid methods of pinpointing faults. Tells WHAT to do and HOW to do it. Includes UHF, COLOR and use of test instruments. NO MATH, NO THEORY, NO FORMULAS. Just practical servicing info covering all types of TV sets.

No. L1.....\$2

**SHOOT TV & RADIO TROUBLE FAST**

Quickest radio & TV trouble shooter locates radio & TV faults in record-breaking time, regardless of make or model. Section on printed circuits. Only book containing radio & TV trouble tracing in one vol.



No. T2.....\$1.50

**RCA & ADMIRAL TROUBLE INDICATING TV TUBE LOCATION GUIDES**



These two books contain the most complete compilation of RCA and ADMIRAL tube location guides ever published.

The RCA volume includes all TV models from the earliest 1947 sets to latest models, more than any 5 ordinary tube chart books.

The ADMIRAL book includes over 1500 Admiral TV models from the earliest sets to the newest 1956 models. Also contains a PICTURE GUIDE to TV tube troubles.

RCA GUIDE—No. A1.....\$1

ADMIRAL GUIDE—No. M1...\$1

**TV PIX GUIDE**



Pictures show oft-recurring faulty TV conditions. Probable causes are explained and logical cures suggested. A second section clearly defines and explains technical TV terms. Over 70 illustrations. 1957 Edition

No. G1.....\$1

**TV DOCTOR**

Just the info. needed to start TV servicing. Includes: How to recognize and remedy TV troubles; How to replace defective tubes including Pix tube; Easy TV trouble checks; Snow; TV: Antenna know-how; How to combat interference, ghosts & Snow; UHF installation & servicing; How to read schematics and much other valuable TV info for beginners.



No. D5.....\$1

**TV TUBE SUBSTITUTION GUIDE**



Tube replacements for TV & radio sets. All fit same sockets and NEED NO CHANGES IN WIRING. Book also contains complete data on PICTURE TUBE replacements, many directly, others with only slight changes.

No. S1...Only 50c

**TV TROUBLE TRACERS**

Six vol's. different TROUBLE INDICATING TUBE LOCATION GUIDES in each. Hundreds of popular TV models. Each vol. has over 70 illustr. 40 most common TV troubles illustrated.

Vol. 1 (No. TT1) Older sets  
Vol. 2 (No. TT2) '52-'53 sets  
Vol. 3 (No. TT3) '53-'54 sets  
Vol. 4 (No. TT4) '54-'55 sets  
Vol. 5 (No. TT5) '55-'56 sets  
Vol. 6 (No. TT6) New PORTABLES & '57 RCA sets

Each Volume.....50c

**FREE:** \$2 WORTH OF BOOKS—FREE—with every purchase of entire CISIN TV LIBRARY of 19 valuable TV service books listed above. Regular Price \$16.50—yours for only \$14.50.

IF JOBBER IS OUT OF STOCK MAIL "NO RISK" TRIAL ORDER COUPON 5-day Money Back Guarantee

H. G. CISIN, Dept. E-44, AMAGANSETT, N. Y.

Enclosed find \$..... RUSH POSTPAID following books:

- |                                    |                                 |                                    |                                  |
|------------------------------------|---------------------------------|------------------------------------|----------------------------------|
| <input type="checkbox"/> K2—\$1.50 | <input type="checkbox"/> A1—\$1 | <input type="checkbox"/> T2—\$1.50 | <input type="checkbox"/> TT2—50c |
| <input type="checkbox"/> K1—\$1    | <input type="checkbox"/> M1—\$1 | <input type="checkbox"/> T1—\$1    | <input type="checkbox"/> TT3—50c |
| <input type="checkbox"/> L1—\$2    | <input type="checkbox"/> G1—\$1 | <input type="checkbox"/> S1—50c    | <input type="checkbox"/> TT4—50c |
| <input type="checkbox"/> D5—\$1    | <input type="checkbox"/> R1—\$1 | <input type="checkbox"/> T1—50c    | <input type="checkbox"/> TT5—50c |
| <input type="checkbox"/> E1—50c    | <input type="checkbox"/> E2—50c | <input type="checkbox"/> TT1—50c   | <input type="checkbox"/> TT6—50c |

Enclosed find \$14.50. Send entire Cisin TV LIBRARY listed above.

Name.....  
Address.....  
City..... Zone..... State.....

# Technicians' News



## ANNUAL CONVENTION

The National Alliance of Television & Electronic Service Associations (NATESA) held a 4-day convention in Chicago, Ill., whose attendance exceeded last year's high of 712.

During the session, a constitutional amendment, eliminating the last possible hindrance to the affiliation of existing state associations with NATESA, was placed in the record to be voted on at the spring directors' meeting. This meeting was voted to Missouri after invitation by a number of NATESA affiliates in that area. Buffalo, N. Y., and Miami, Fla., also extended invitations.

New officers were elected, with Russell Harmon of Cincinnati, Ohio, selected to succeed Robert Hester as president. Hester could not succeed himself. Mac Metoyer, Kansas City, was voted secretary while Nelson Burns, Memphis, Tenn., was renamed treasurer. Bertram Lewis, Rochester, N. Y.; Cordell Britt, Nashville, Tenn.; Vincent Lutz, St. Louis, Mo.; and Winston Haines, San Mateo, Calif., were elected as vice presidents in their respective divisions. The following were elected secretary for their division: Pat Pratt, Buffalo, N. Y.; Marvin Miller, Springfield, Ohio; Joe Driscoll, St. Paul, Minn.; A. Andrew, Denver.

## ESFETA MEETS

Licensing was the major issue discussed at the regular September meeting of the Empire State Federation of Electronic Technicians Associations, Inc. (ESFETA), held in Ithaca, N. Y. Ben DeYoung acted as the host.

Dan Hurley, ESFETA president, pointed out that there was a possibility that captive service would benefit from a governmental licensing program. This would be due to the possibility of 30% of the practicing technicians being eliminated, leaving an expanded market for the manufacturer.

Robert Henderson, Long Island delegate, stated that the self-licensing program in their area hasn't brought any noticeable response from the public. George Carlson, secretary, reported that Jamestown's self-certification program has resulted in public response, but only when individual members advertise their membership and the association presents the program through local advertising.

Bert Lewis, eastern vice president of NATESA, representing Rochester, urged ESFETA to encourage its members to participate in the CBS transistor training program.

**ONE SOURCE**

FOR ALL YOUR TRANSFORMER NEEDS...

# STANCOR

One line will satisfy the huge majority of your transformer needs... STANCOR. Why waste time shopping around? You can depend on your STANCOR distributor to have the transformer you want, always.

Do you have our latest catalog and replacement guides? Write for them today. (Free, of course.)

**CHICAGO STANDARD TRANSFORMER CORPORATION**  
 3509 ADDISON STREET • CHICAGO 18, ILLINOIS

Export Sales: Roburn Agencies, Inc., 431 Greenwich St., New York 13, N.Y.

## INVENTORS

Send for  
**PATENT INFORMATION**  
 Book and  
**INVENTORS RECORD**  
 without obligation  
**GUSTAVE MILLER**  
 117-RE WARNER BUILDING  
 WASHINGTON 4, D. C.

**REGISTERED PATENT ATTORNEY**  
 ASSOCIATE EXAMINER  
 U.S. PAT. OFF. 1922-1929  
 Patent Attorney & Advisor  
 U.S. Navy Dept. 1930-1947  
**PATENT LAWYER**

\$

**TV SERVICEMEN!**  
 MAKE \$50—\$100 EXTRA PER WEEK  
 Install Surgistors on all calls  
 See your distributor or write:  
**WUERTH TUBE-SAVER CORP.**  
 9125 Livernois Ave., Detroit 4, Mich.

\$

## FREE! COMIC AD CARD KIT

**FREE CATALOG TOO!**—shows our complete line of TV Service Reports, Call Books, Phone Message Books, Job Tickets, Service Pricing Guide, File Systems, Service Contracts, Parts Warranties, P. O. Forms, Statement Books, Label Books, Sketch Pads, Cash Books, etc. See them at your parts jobber. **WRITE NOW!**  
**Oelrich Publications** 4308 Milwaukee Ave.  
 Chicago 41, Illinois

## GARAGE DOOR OPENER

Actuator Mechanism **\$24.50**  
 EASY TO INSTALL, SAFE, RELIABLE  
 WRITE for interesting free information TODAY  
**P. E. HAWKINS CO.**  
 631 PROSPECT DEPT. R-E KANSAS CITY 24, MO.

The next meeting will be held Nov. 10 in Rochester. Norbert LeMay will act as host.

### SERVICE SEMINAR

Fifty representatives of independent service organizations had a 2-day seminar at Lancaster, Pa. in the early part of September. Conducted for discussion of the latest improvements and developments in service techniques, and sponsored by RCA, a tour of the color picture-tube facilities at RCA's Lancaster plant and a preview of the fall color TV receiver sales program was included. The Quality Control Laboratory at Browns Mill, N. J., and the David Sarnoff Research Center, Princeton, N. J., were visited during the closing day of the session.

Addressing the group, D. R. Creato, secretary and vice-president of the RCA Service Co., noted that electronics has become an \$11.5-billion-a-year industry and that servicing represents \$2.8 billion or, roughly, a quarter of this total.

### APPRENTICESHIP GUIDE

The Minnesota Television Service Engineers, Inc. (MINTSE) and Tung-Sol Electric Inc. have jointly published a Radio-TV Apprenticeship Standards Guide. The booklet, called *Service Standards*, contains a complete description of MINTSE's apprenticeship program.

According to John W. Hemak, who compiled the manual, its purpose is "to establish a foundation for the eventual recognition of electronic service as a professional activity."

The guide was printed by Tung-Sol through the efforts of Robert M. Andrews, manager of electronics and semiconductor products advertising. Copies are free to all jobbers, dealers and associations. They may be obtained from local Tung-Sol jobbers or by writing: TTLB, Special Services Dept., P. O. Box 1321, Indianapolis, Ind.

### NEW SERVICING IDEA

A new group called Telectro Service Associates, Inc., has been formed in Detroit, Mich. A profit-making organization, it was formed by independent service dealers to promote and contract service for the service dealer.

Telectro has signed contracts with Philco and Sylvania to handle their warranty service on television, radios and phonographs. Local Hotpoint distributors have also selected Telectro to perform this job for them. Independent local service dealers will handle work in their area.

Officers of Telectro are: Karl Heinzman, H. & M. Electric, president; John Keppinger, Grosse Pointe Radio, vice president; Philip Fabian, Dexter TV, secretary, and Edward Brown, Visual Electronics, treasurer.

Board members are: E. J. Barton, Barton TV, 2 years; Steve Raboczky, Southwest TV, 2 years, and Edward Corrozzi, Supreme TV, 1 year. END

SPECIALLY PRICED DURING NOVEMBER!

## THE BEST TOOL DEAL YOU EVER SAW!



**TV ALIGNMENT TOOL KIT**

CONTAINS 4 BASIC TV TOOLS

To introduce this new kit that's sure to handle most of your TV set alignment work, G-C has specially priced it for one month only. Roll-type plastic case holds the four tools safely in your pocket or tool box. Buy now and save!

**SPECIAL THIS MONTH ONLY \$1.49**

SEE YOUR G-C JOBBER NOW!

FREE G-C CATALOG...send postcard today!

NO. 8457

## GENERAL CEMENT MFG. CO.

Division of Tectron Inc.

400 South Wyman Street • Rackford, Illinois

**DON'T REMOVE THAT CR TUBE!**



Snap it back to normal brilliance with new improved Kinecure. INSTANTLY and PERMANENTLY corrects 33 different CRT defects. Saves time, money, and irritation for both servicemen and customers. Thousands of TV servicemen now use new, improved Kinecure. Now time tested and job proven on over 50,000 sets. There is just nothing else like patented Kinecure. It looks different — operates different — works like a charm! Ask your Jobber. Or write for free full information.

**CIRCUIT MANUFACTURING CO., INC.**  
923 Shadeland Ave., Drexel Hill, Pa.

# NOW... ENJOY HIGHER FI!

At last, a book written just to help give your hi-fi system the golden voice you want—within the limits of your budget! In his latest book, **UNDERSTANDING HI-FI CIRCUITS**, Norman H. Crowhurst, hailed on both sides of the Atlantic as an outstanding hi-fi authority, tells you which phase inverter is best, whether fixed or self bias gives less distortion in the power output stage, the merits of triode vs. pentode, how to use feedback, etc. He answers hundreds and hundreds of other questions to help you decide for yourself which circuit is best for you to reach the performance level you want.



This unusual book, handsomely bound in a deluxe 2-color gold leaf-stamped cloth cover, sells nationally for \$5 but through the unique G/L Audio Hi-Fi Book Club, you can get it at the wholesale price of only \$3.75! Read how you can get **UNDERSTANDING HI-FI CIRCUITS** and other great books by top drawer hi-fi writers like Marshall, Hoefler, Burstein and others—all at a saving of 25%.

## How to Get This Book At a Big Saving!

- ✓ To enroll in the G/L Audio Hi-Fi Book Club fill in your name and address and indicate the book you want on the coupon below. **SEND NO MONEY!**
- ✓ We will send you the book you choose for a 10-day inspection in your own home. If you like it keep it and send your remittance of \$3.75—the special wholesale club price. (We pay postage.)
- ✓ If not satisfied simply return the book in the container in which you received it.
- ✓ A new book will be sent to you on the same no-risk inspection plan about every four months.
- ✓ You agree to take a minimum of only four books for the whole period of enrollment—no time limit. You may cancel any time after that.

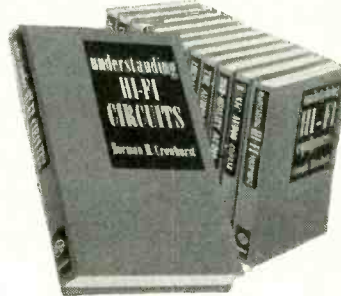

## Other Books Already Published

### ◆ NEW—JUST OFF THE PRESS

**Elements of Tape Recorder Circuits**—By Burstein and Pollak. Now in one book—everything you want to know about the electronic side of tape recorders. What to look for when you buy—why one works better than another—how to get maximum performance from all types. Covers fundamentals, amplifiers, head, bias, equalization, oscillators, design principles and many other phases for both hi-fi fans and technicians.

**Basic Audio Course**—By Donald Carl Hoefler. Complete coverage of theory and fundamentals

from the physics of sound to advanced techniques, including amplifiers, feedback, power supplies, distortion, attenuators, speaker systems, and so much more it is impossible to list all here.

**Maintaining Hi-Fi Equipment**—By Joseph Marshall. Now for the first time—learn the techniques necessary to recognize and repair hi-fi troubles. Covers acoustic as well as electronic, electrical and mechanical faults. A must for the professional hi-fi man—or any audiophile who really cares about his hi-fi system.

### Books for Future Publication

These books will be published one-at-a-time at regular intervals and sent to club members for home inspection, just as soon as they come off the press.

- High-Quality Audio
- Audio Data Book
- Loudspeaker Enclosures

- Audio Hints
- Constructing Audio Amplifiers
- Loudspeakers—and Speaker Systems

### All these exclusive features yours with membership

- ✓ No-risk inspection plan
- ✓ First choice of latest hi-fi books at regular intervals
- ✓ Best hi-fi authors write specially for you
- ✓ Handsome and durable gold leaf stamped cloth covers
- ✓ **SAVINGS OF 25% over the \$5 retail price!**

**SAVE \$1.25 on each book—join the G/L Audio Hi-Fi Club today—you have nothing to lose—everything to gain**

**SEND IN THIS COUPON NOW**

Remember **YOU SEND NO MONEY!** You keep only the books you want—pay only for those you keep!

### — NO-RISK COUPON —

**GERNSBACK LIBRARY, Inc., Dept. 117C**  
154 West 14th St.  
New York 11, N.Y.

- Enroll me in the G/L Audio Hi-Fi Book Club. Begin my membership with the book checked below.
- UNDERSTANDING HI-FI CIRCUITS
- BASIC AUDIO COURSE
- MAINTAINING HI-FI EQUIPMENT
- ELEMENTS OF TAPE RECORDER CIRCUITS
- Send me more information about the G/L Audio Hi-Fi Book Club

Name ..... please print

Street .....

City.....Zone.....State.....

**Perma Power**

### COLOR GUN KILLER

Operates Guns Individually to make color purity adjustments.

Model T-101 \$495  
List Price

### COLOR KINESCOPE ADAPTER

To test color kine on black and white testers.

Model T-201 \$450  
List Price

### COLOR BRITE

Color TV Tube Britener.

Model C-501 \$975  
List Price

At all distributors

**Perma-Power COMPANY**

## COLOR TV SERVICE AIDS



3100 N. ELSTON AVE.  
CHICAGO 18, ILLINOIS

There's always something new being developed by Perma-Power

## TERADO Trav-Electric MOBILE POWER CONVERTERS

Give You **110 A.C. HOUSE CURRENT ANYWHERE**  
You Drive or Cruise



LIST

For 6 and 12 Volt Car Batteries—Capacities: 10 to 125 Watts **\$11.95 UP**

**NO INSTALLATION**  
Just plug into cigar lighter on dash of car, truck, or boat—and away we go

- OPERATE PORTABLE TV,
  - SMALL DO-IT-YOURSELF
  - TOOLS WHEREVER NEEDED
- One of the great conveniences of our electronic age



PORTABLE TV



DICTIONARY

**101 USES**



ALL ELECTRIC SHAVERS



DO-IT-YOURSELF HOBBY TOOLS

SEE YOUR ELECTRONIC PARTS DEALER OR JOBBER

**TERADO COMPANY**

DESIGNERS & MFRS. OF ELECTRONIC EQUIPMENT SINCE 1927

1057 RAYMOND AVE., ST. PAUL 14, MINNESOTA



# New Tubes & Semi-conductors

The manufacturers have presented a versatile group of vacuum tubes and semiconductor devices this month. There's the world's first power tetrode transistor; a photocell that needs no amplifier circuit; a miniature power-output tube; a 110° picture tube and a rectangular 3-inch C-R tube. And to round out the collection you'll find an 85-watt power transistor.

## H200E

A germanium p-n-p alloyed-junction power-tetrode transistor and designed to operate from 28-volt collector supplies, its linear amplification over wide current ranges permits high power output with low distortion. It is made by Minneapolis-Honeywell. A power

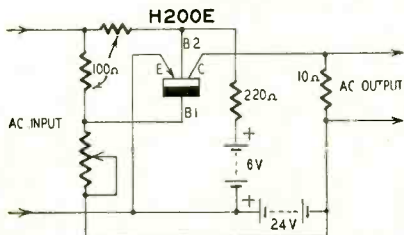

output stage to demonstrate its excellent linearity is shown in the diagram. A low-distortion high-efficiency high power output is achieved without feedback and without input transformer drive. Hence, the circuit may be R-C-coupled or direct-coupled to a preceding stage. Up to 5 watts output can be obtained.

## 2N332, 3, 4, 5, 6

These grown-junction silicon transistors are especially designed for high-gain low-level applications where maximum reliability at a high ambient temperature is of prime importance. Made by Texas Instruments, the maxi-

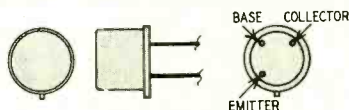

2N332, 3, 4, 5, 6

mum temperature range of these units is  $-55^{\circ}\text{C}$  to  $175^{\circ}\text{C}$ . Input impedance ( $h_{ib}$ ) for all five units has a design center of 42 ohms, when  $C_{CB} = 5\text{V}$  and  $I_{B} = -1\text{ma}$ ; and the noise figure (NF) has a design center of 20 in the common-emitter configuration compared to a 1,000-ohm resistor.

The following maximum ratings (at  $25^{\circ}\text{C}$ ) apply to all five units:

$V_{CB}$	45
$V_{EB}$	1
$I_C$ (ma)	25

# NEW AUTOMATION PUNCHED CARD TV TUBE TESTER

# PROVED!

## IN OVER 1 MILLION TUBE TESTS!



Fastest, most complete portable dynamic mutual conductance tester!

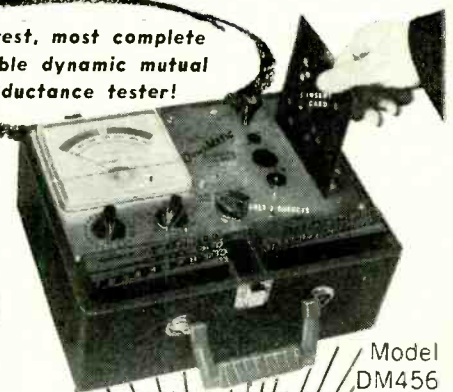

Model DM456

Speed-test complete set of tubes in minutes with the new DynaMatic Tube Tester

- So simple to use—a customer can operate it!
- LIGHTEST and SMALLEST Gm tester available. Take it on ALL house calls.
- Perforated plastic cards set up socket pin connections and test voltages.
- Permits full-complement tube testing.
- DynaMatic is a dynamic mutual conductance tester—NOT an emission checker.
- Accurately measures mutual conductance in micromhos on 2 ranges. 0-6000, 0-18000.
- Also checks battery tubes.
- Needs only 58 cards for complete testing.

Dealer Net

**149<sup>95</sup>**

Prices slightly higher west of the Rockies

## IMMEDIATE DELIVERY!



136-10 31st Road, Flushing 54, N. Y.

## 2 WAY PORTABLE RADIO SET

**Sends—Receives up to 10 miles as shown**  
or hundreds of miles with outside antenna! 80 and 40 meter amateur radio bands (novice) also Aircraft and overseas broadcasts (3 to 8 mc.) POWERED WITH SELF-CONTAINED PORTABLE RADIO BATTERIES. NO AC PLUG-INS NEEDED! Take it with you everywhere you go—Keep in contact with home-friends. Has 5 watt crystal controlled transmitter—Sensitive Regenerative Receiver. Send receive switch. Wt. only 3 lbs. Size, only 6" x 4". TESTED—PROVEN—SIMPLIFIED—PRACTICAL—Full information given on quick easy to get license.  
**SEND ONLY \$3.00** (bill, ex. mo) and pay post-man \$11.95 COD postage on arrival or send \$14.95 for postpaid delivery. Complete kit includes all parts, tube, coils, plastoid cabinet, easy instructions. (Set of batteries—\$2.95; crystal \$1.25). COMPLETELY WIRED AND TESTED POSTPAID \$19.95. A regular \$49.95 value—Order now before price goes up. GUARANTEED—AVAILABLE ONLY FROM: WESTERN RADIO, Dept. BNR-11, KEARNEY, NEBR.



## NEW! 5-Transistor Pocket Radio!



Size of cigarette pack-age. No external antenna needed. Brings in stations 800 miles away at night. Loud volume. Uses 12 1/2-cent flashlight battery that lasts 600 hours. Printed circuit. Free literature.

Complete kit.....	\$25.90	Fully wired.....	\$32.20
Excise tax.....	2.60	Excise tax.....	3.30
Total of.....	\$28.50	Total of.....	\$36.50

GARDINER ELECTRONICS CO., Dept. 12  
2545 East Indian School Road • Phoenix, Arizona

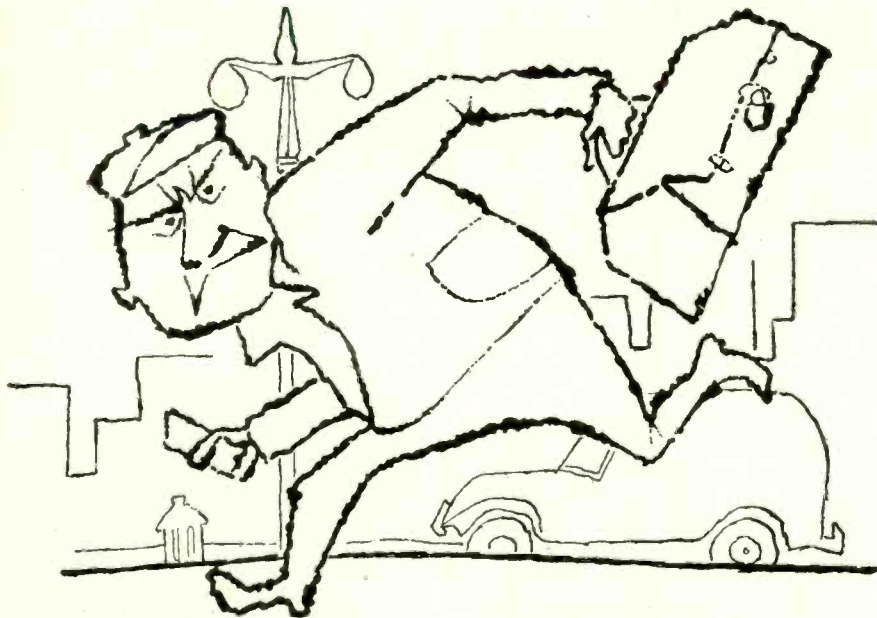

# STOP CB\* WITH C-D

\*STOP PROFITLESS CALL BACKS by using C-D "BLUE BEAVERS"<sup>®</sup>. The tubular electrolytic that actually improves original factory performance. The built-in extra "factors of safety" insure call-back-free servicing, customer satisfaction and money in your pocket. "BLUE BEAVERS" are made exclusively for the service trade.



SPECIAL! "BLUE BEAVER SERVICE KIT"—a practical assortment of "every day" tubular electrolytics in all-plastic dispenser. You pay only for the capacitors. Ask your distributor salesman to show you the "BLUE BEAVER KIT" or write for details to Dept. RC-97 Cornell-Dubilier Electric Corp., South Plainfield, New Jersey.



stop call backs...insist on

## CORNELL-DUBILIER CAPACITORS

SOUTH PLAINFIELD, N. J.; NEW BEDFORD, WORCESTER & CAMBRIDGE, MASS.; PROVIDENCE & HOPE VALLEY, R. I.; INDIANAPOLIS, IND.; SANFORD, FUYQUAY SPRINGS & VARINA, N. C.; VENICE, CALIF.; & SUB.: THE RADIART CORP., CLEVELAND, O.; CORNELL-DUBILIER ELECTRIC INTERNATIONAL, N. Y.

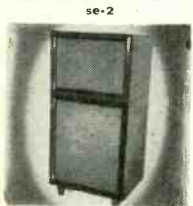

## SPEAKER ENCLOSURES

An inexpensive enclosure system priced for your budget. Start with the SE-2 which is cut for an 8" woofer and horn type tweeter. When budget allows, add SE-1 to hold a 12" woofer and cross over network. Both cabinets acoustically lined for fine performance and finished in your choice of Mahog., Walnut, Maple, or Pine.

SE-2 16"-12"-11 1/2" ..... \$18.75 } F.O.B.  
SE-1 16"-12"-21" ..... \$29.75 }

S. J. MAJEIKA CO.

RD-1 Cove Rd.

Westerly, R.I.

LOWEST PRICES ANYWHERE  
Picture Tubes—Transmitter Tubes—Radio & TV Parts  
WRITE FOR STANLEY'S NEW FREE CATALOG  
DUMONT AND RCA INC.  
**BRAND NEW TV PICTURE TUBES**  
UNCONDITIONALLY GUARANTEED FOR ONE YEAR  
No dud required

10" Tube.....\$10.95	17" Tube.....\$17.95
12" Tube.....\$12.95	19" Tube.....\$20.95
14" Tube.....\$14.95	20" Tube.....\$20.95
16" Tube.....\$16.95	21" Tube.....\$22.95

Add \$4.00 to above prices for aluminized tubes  
TERMS: 25% deposit on all way Express.  
COD's, Picture tubes F.O.B. Parsippany, N. J. via Rail-way Express.

**STANLEY**  
ELECTRONICS CORP.

840 MAIN ST.  
PATERSON, N. J.

### NEW TUBES & SEMICONDUCTORS (Contd.)

$I_E$ (ma)	-25
$P_C$ (mw)	150
at 100° C	100
at 150° C	50

Center design ratings:

	2N332	33	34	35	36
Power gain ( $PG_E$ )	35	39	39	42	42.5
( $V_{CE} = 20$ , $I_E = -2$ ma)					
( $R_K = 1$ k, $R_L = 20$ k)					
Frequency cutoff (mc)	4	5	8	6	7
( $V_{CB} = 5$ , $I_E = -1$ ma)					

### 6957

Head-on type of cadmium-sulfide photoconductive cell for use in light-operated controls. High illumination sensitivity permits direct relay operation in most applications without an amplifier. The unit is made by RCA.

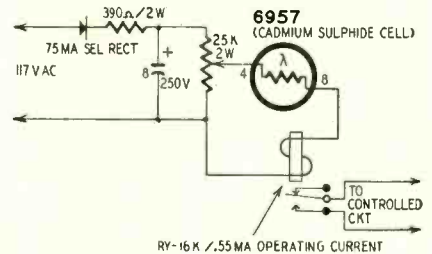

Maximum ratings are: polarizing voltage, 250; power dissipation, sensitive surface fully illuminated, 0.5 watt; photocurrent 50 ma.

The diagram shows a typical high-sensitivity circuit using the 6957. The cell connects to pins 4 and 8 of an octal base.

### Abbreviations

A number of abbreviations used in reference to transistor characteristics are often confusing. To end any doubt as to what a particular symbol stands for this list has been assembled.

- $I_C, I_E, I_B$ —Dc currents to collector, emitter or base.
  - $V_{CB}$ —Voltage, collector to base.
  - $V_{EB}$ —Voltage, emitter to base.
  - $V_{CE}$ —Voltage, collector to emitter.
  - $V_{BE}$ —Voltage, base to emitter.
  - $BV_{CBO}$ —Breakdown voltage, collector-to-base junction reverse-biased, emitter open-circuited (value of  $I_C$  should be specified).
  - $V_{CE0}$ —Voltage, collector to emitter, at zero base current with the collector junction reverse-biased. Specify  $I_C$ .
  - $BV_{CEO}$ —Breakdown voltage, collector to emitter, with base open-circuited.
  - $V_{OCB}$ —Supply voltage, collector to base.
  - $V_{OCB}$ —Supply voltage, collector to emitter.
  - $V_{BEB}$ —Supply voltage, base to emitter.
- Watch for more of this list next month.

### 2N451

This 65-volt 85-watt silicon power transistor, is designed to be used in dc-dc or dc-ac converters as well as servo amplifiers, engine controls and power supplies. Capable of dissipating

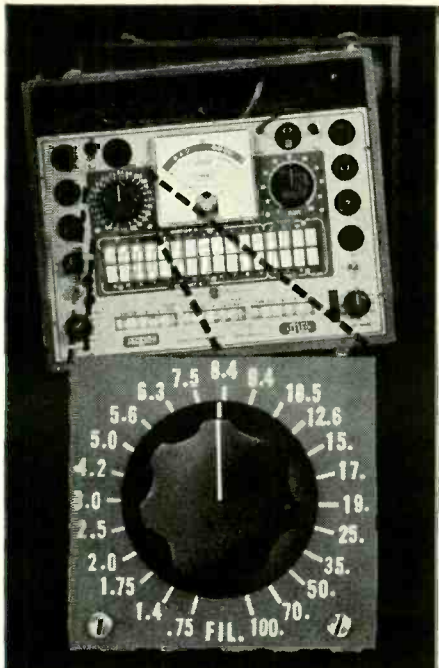

**23 Separate Heater Voltages on the Dynamic® JACKSON 648A Assure Accurate Tests for all Series-String Tubes ...The Correct Voltage for Every Known or Presently Planned Type.**

**YOU CAN MODERNIZE YOUR PRESENT 648**  
 New 648 FV Kit provides same heater voltages as the new 648A Tester. Only four wires to solder. Installs in minutes. Available from your distributor now.



*"Service Engineered" Test Equipment*

16-18 S. Patterson Boulevard • Dayton 2, Ohio  
 In Canada: The Canadian Marconi Company

**NEW TUBES & SEMICONDUCTORS (Contd.)**

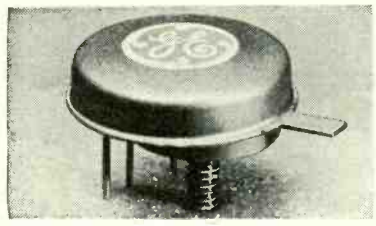

85 watts at 25° C, the G-E 2N451 has a nominal collector saturation resistance of 2 ohms.

Input impedance at a collector current of 1 amp is 25 ohms at 25° C. Maximum collector current rating is 5 amperes. Beta cutoff is 400 kc.

Produced by a vapor-diffusion process, the 2N451 is hermetically sealed in an all-welded case designed for mounting on an external heat sink by means of a single threaded stud.

**21CQP4**

A 21-inch rectangular glass type television tube, it uses 110° magnetic deflection and electrostatic focusing. Announced by Sylvania, the 21CQP4 utilizes a straight electron-gun design,

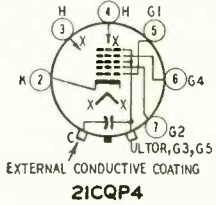

eliminating the need for an ion trap. It has a 6.3-volt 600-ma heater with a controlled warmup time of 11 seconds.

Maximum ratings are:

Ultor voltage	19,800
V <sub>g1</sub> (pos value)	1,100
(neg value)	550
V <sub>g2</sub>	550
V <sub>g1</sub> (neg bias value)	154
(neg peak value)	220
(pos bias value)	0
(neg bias value)	2
Peak, heater-cathode voltage (during warmup)	200
(15 sec)	450

**6973**

A high-perveance beam-power tube of the nine-pin miniature type, designed for use as a power amplifier in high-fidelity audio equipment. Announced by RCA, it has a 6.3-volt 450-ma heater.

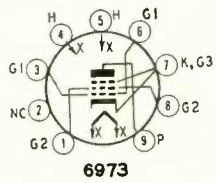

Typical operating values when used in a push-pull af power-amplifier circuit, pentode-connected with fixed bias, are:

<i>Values are for 2 tubes</i>			
V <sub>P</sub>	250	350	400
V <sub>g2</sub>	250	280	290
V <sub>g1</sub>	-15	-22	-25
Peak af g1 to g1 voltage	30	44	50

■ "High fidelity" might be defined as the precision reproduction of music by a system of specialist-built components. Among these components—amplifiers, radio tuners, record players—nowhere is precision workmanship more important than it is in the loudspeaker.



Only JBL Signature speakers are made with 4" voice coils ... such as the 15" JBL D130 Extended Range unit.



Only the JBL Signature D123 is made with a frame so shallow that it may be mounted flush with wall surface.



Only JBL Signature High Frequency components are made with acoustical lenses for smooth treble distribution.

*in a high fidelity loudspeaker*  
**PRECISION**  
*... is the measure of*  
**QUALITY**



The ring radiator in the 075 High Frequency unit is an exclusive JBL Signature development.



Most handsome and versatile speaker enclosure made—the JBL Signature Harlan.

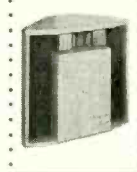

Universally acclaimed first choice for high fidelity—"Dream Set"—the JBL Signature Hartsfield.



Most popular enclosure—the JBL Signature Model C34 back-loaded folded horn.



Speakers of the highest precision bear this trademark. "JBL" means James B. Lansing Sound, Inc.

■ Consider the function of a loudspeaker. It must vibrate at exactly the same frequency as the electrical signal fed to it by the amplifier. This frequency may vary from 30 to as many as 15,000 times a second! Consider that now we are not dealing with electrons of negligible mass, neither are we working with a tiny phonograph stylus; in a loudspeaker we must control the actual physical movement of a considerable mass of metal and fiber. A moment's reflection will show that in this component precision workmanship is all important.

■ JBL Signature Speakers made by James B. Lansing Sound, Inc., are made with that degree of precision usually associated with scientific instruments or navigational chronometers. Perhaps they should not be called "loudspeakers" at all, but should be given the more technically correct appellation: precision transducers. No matter how difficult the manufacturing operation, if a refinement will result in better sound, it is built into JBL Signature Loudspeakers.

The place to see and hear JBL Signature units is in the component demonstration room of the authorized JBL Signature High Fidelity Sound Specialist in your community.

For his name and address, write to:  
**James B. Lansing Sound, Inc.**  
 3249 Casitas Ave. • Los Angeles 39, Calif.

# ASTRON

## Aids

### FOR SERVICEMEN

#### Estimating and Pricing Guide

Handy, pocket-sized Replacement Catalogue containing illustrations, descriptive copy, and complete breakdown of catalogue numbers, sizes, capacitance, working voltage, and list price. It saves valuable time for you every day. Free Servicing Aid AC-4D.

#### General Capacitor Catalogue

Complete line of Astron capacitors illustrated and explained in detailed 8½ x 11 coated stock catalogue. Valuable information written in an easy-to-understand style. Diagrams, charts, and descriptive copy concerning each type. Service Replacement Capacitor Catalogue number AC-5.

#### Popular Astron Swing Bins

Practical capacitor servicing kit. Sturdy, clear plastic swivel trays mounted as one unit for your convenience. Will keep capacitors off the work bench — and in place where you know they'll be found... completely visible from any angle, any position... neat, compact and handy. Three different styles available:

Swing Bin Sr. 9 shelves 166 Blue•Point® Plastic Paper Tubular Capacitors  
Swing Bin Jr. 6 shelves 90 Blue•Point® Plastic Paper Tubular Capacitors  
Swing Bin Baby 4 shelves 45 Blue•Point® Plastic Paper Tubular Capacitors

Available nationally through authorized ASTRON distributors.

# ASTRON CORPORATION



255 GRANT AVENUE  
EAST NEWARK, N. J.

#### NEW TUBES & SEMICONDUCTORS (Contd.)

$I_p$ (0 sig) (ma)	92	58	50
(max sig)	105	106	107
$I_{ke}$ (0 sig) (ma)	7	3.5	2.5
(max sig)	16	14	13.7
$R_p$ (plate to plate) (k ohms)	8	7.5	8
Total harmonic distortion (%)	2	1.5	2
Max sig pwr output (watts)	12.5	20	24

#### 3AHPI, 2, 7, 11

This rectangular cathode-ray tube uses electrostatic focusing and deflection. It is 9.12 inches long, has a 6.3-volt 0.6-amp heater and is produced by Waterman Products Co.

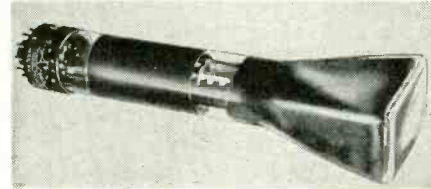

Typical operating conditions are:

$V_{A2}$	2,000
$V_{A1}$	330-620
$V_{g1}$	158 to 135
Deflection factors	
D1 and D2	146-198
D3 and D4	52-70

Basing diagram same as for 3RP1.

#### 4JD4A4, 5

These silicon triode transistors are intended for amplifier applications in af and rf ranges. Both are diffused-junction devices manufactured by General Electric by a diffused-meltback process. They have a nominal input



4JD4A4,5

impedance ( $h_{in}$ ) of 55 ohms, when  $I_E = -1$  ma and  $V_{CB} = 5$ . Nominal current-transfer ratio is 15 for the 4JD4A4 and 40 for the 4JD4A5, when  $I_E = -2$  ma and  $V_{CB} = 5$ .

Maximum ratings at 25° C are:

$V_{CBO}$	30
$V_{CEO}$	15
$V_{EBO}$	5
$I_C$ (ma)	30
$P_C$ (mw) (25° C)	150
(150° C)	25

Nominal frequency cut-off (mc)  
( $f_{ab}$ )  $I_E = -2$ ma  
 $V_{CB} = 5$  25

#### RCA pix tubes

Three 90° television picture tubes have been announced by RCA. All have a straight gun design and do not need an ion-trap magnet. They are the 21CBP4-A, 24AEP4 and 17BJP4.

#### 6DQ5 Correction

An errata notice from RCA has indicated a change in the information presented in their original specifications for the 6DQ5, which appeared in the September issue on page 138. The connections for grid 1 and grid 2 were reversed. The correct connections should be: Pin 1 connects to grid 1 and pin 4 connects to grid 2.

## FULL FIDELITY MUSIC ENJOYMENT

### TWIN-CONES IN A SINGLE

\**F.R.S.* SPEAKER COVER THE AUDIBLE RANGE

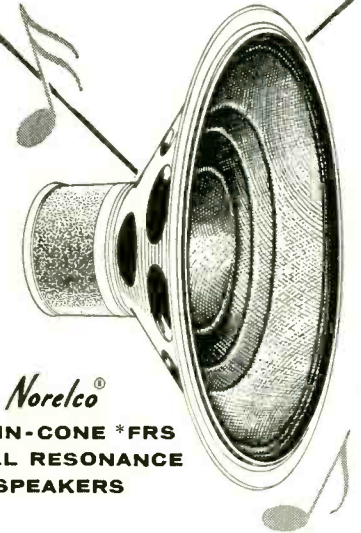

Norelco®

TWIN-CONE \*FRS  
\*FULL RESONANCE SPEAKERS

In a single speaker, Norelco has created an unusually efficient sound radiator. These twin-cone speakers incorporate a small cone for reproducing high frequencies and a large cone for lower frequencies. Both cones operate in conjunction from a single voice coil — producing balanced sensitivity and uniform sound for all ranges. Arrangement of both cones reflect and diffuse the sound while moving in phase to provide even sound distribution.

A deep air gap within a homogeneous magnetic field provides unusually large movement of the voice coil resulting in distortion-free reproduction over the entire frequency range. Impedance does not diminish with higher frequencies and volume is practically constant throughout the whole audible range.

Send today for your catalog on Norelco \*FRS Twin-Cone Speakers. It contains specification data, sound distribution curves, frequency characteristics on these speakers as well as the new Norelco Speaker Enclosures.



Send to Dept. D-11 for more details

NORTH AMERICAN PHILIPS CO., INC.  
High Fidelity Products Division  
230 Duffy Ave. Hicksville, L. I., N. Y.

# radio-electronic Circuits

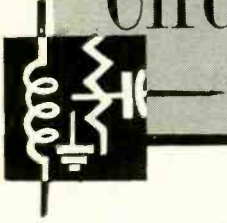

## FM ANTENNA

Recently I constructed an omnidirectional FM receiving antenna from details in the article "All-Way FM Antenna" in the March 1948 issue of RADIO-CRAFT. The antenna worked so well that I'd like to recommend it to those who haven't seen it.

The dimensions on the diagram are for the FM broadcast band. The dipoles (A) are made of 300-ohm ribbon and are 0.45 wavelength long. The square is 0.5 wavelength

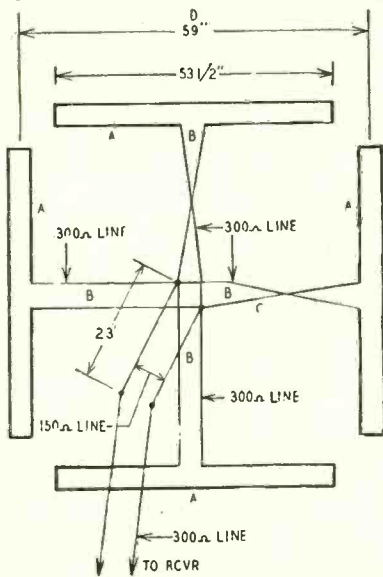

long on each side. The four antennas in parallel have an effective impedance of 75 ohms when connected as shown by 0.25-wavelength phasing sections (B). The 75-ohm feed-point impedance is matched to the 300-ohm transmission line (lead-in) by a 0.25-wavelength section of 150-ohm line (C).

For other frequencies the dimensions of A, B, C and D in inches may be found by dividing 5,350, 2,950, 2,300 and 5,900, respectively, by the frequency in megacycles.—Henry O. Maxwell

## LIGHT SWITCH CONTROLS GARAGE-DOOR OPERATOR

I wanted to install an electrically controlled solenoid release for a spring-operated garage-door opener in a home with a garage light controlled from a remote switch in the house. To avoid putting in special wiring and switches, I worked out a scheme for controlling the door operator and garage light individually from the original light switch. The circuit shown is designed so normal operation of the light switch will not activate the door opener but

**NOW—**  
Get it from  
**your Parts  
Jobber!**

**Admiral—**  
rated by servicemen  
as the most foolproof  
and trouble-free of  
all changers!

**Admiral—**  
built into more  
phonos and combinations  
than any other  
changer in the world!

# Admiral®

## 4-Speed Record Changer

*Hi-Fidelity*



Beige and Coral  
with Golden Trim  
(Base Optional)

- **PLAYS ALL FOUR SPEEDS—** 33 $\frac{1}{3}$ , 45, and 78 plus "talking book" 16 $\frac{3}{4}$  r.p.m. Has neutral position. Changes 12 to 14 records; intermixes those of same speed. Automatic 2-way shut-off after last record. Returns tone arm to rest, stops turntable motor completely. NOTE: Can be wired to shut-off radio or amplifier chassis.

- **RUBBER TURNTABLE MAT**

- **FEATHERWEIGHT TONE ARM—** new resonance-free design. Less than  $\frac{1}{8}$  oz. pressure. Positive tracking . . . no "skip" or "jump" on loud passages.

- **DIAMOND LP STYLUS—** separate LP diamond and 78 r.p.m. sapphire needles for finest sound reproduction, long record life.

- **ATTACHED 40" SHIELDED AMPLIFIER CABLE—** eliminates pickup of unwanted noise. Cable has phono tip plug for quick easy connection into standard input phono-tip jack.

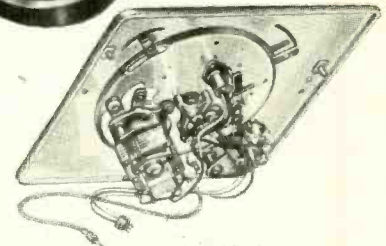

**HEAVY DUTY MOTOR—** powerful 4-pole constant speed shaded pole induction type motor. Operates without hum, rumble or "wows" (as little as 0.1590). Maintains even speed even if line voltage varies. Six foot line cord attached.



**CERAMIC PICK-UP CARTRIDGE**  
—twin lever hi-fi cartridge changes with flick of the finger from LP to 78 r.p.m. needle. Impervious to heat and humidity. High lateral compliance minimizes wear, eliminates hum and distortion. Smooth even response ( $\pm 3$ db) over the full high-fidelity frequency range (30-15,000 c.p.s.).

Write for Illustrated Specification Sheet.

**Admiral®**

SPECIAL PRODUCTS DIVISION  
3800 West Cortland Street  
Chicago 47, Illinois



MORE THAN **2,000,000** RIDER BOOKS  
SOLD IN 2 YEARS, ON RADIO - TV - ELECTRONICS - AUDIO!

**Famous RIDER "Picture-Book" Courses ...**

**BASIC TELEVISION**

by Dr. Alex. Schure

The whole world of black and white television is before you for only \$10.00. You can master the basics of television easily and thoroughly with this 5-volume "learn by pictures" training course.

**It's so easy to learn**

Here's how this easy, illustrated course works. Every page covers one complete idea! There's at least one big illustration on that same page to explain it! You build a thorough, step-by-step knowledge at your own pace—as fast as you yourself want to go.

**No experience, education needed**

BASIC TELEVISION uses the same methods that have proven so successful in the famous Rider picture books on electricity and electronics. All that is assumed is that you have a knowledge of radio. Every phase of television is made instantly clear—explained in plain English supported by carefully prepared, large and exciting drawings that make every idea crystal clear.

**10-day examination—Money Back Guarantee**

≠198, soft cover 5 volumes, \$10.00 per set:  
≠198-H, cloth bound in a single binding, \$11.50

**BASIC ELECTRICITY**  **BASIC ELECTRONICS**  
 **BASIC SYNCHROS & SERVOMECHANISMS**

by Van Valkenburgh, Nooger Neville, Inc.

The fabulous picture-text books that teach faster and easier! The theory, principles, and practice of electricity, electronics, and synchros and servos are here presented in a manner that permits a rapid grasp of the fundamentals of these vitally important subjects. Over 2,000 specially prepared illustrations present, explain, and make every topic discussed picture-clear.

**Basic Electricity**

≠169, soft cover, 5 vols., 624 pp., per set \$10.00

≠169H, cloth bound in single binding...\$11.50

**Basic Electronics**

≠170, soft cover, 5 vols., 550 pp., per set \$10.00

≠170H, cloth bound in single binding...\$11.50

**Basic Synchros and Servomechanisms**

≠180, soft cover, 2 vols., 270 pp., per set \$5.50

≠180H, cloth bound in single binding...\$6.95

**BASIC PHYSICS** by Alex. Efron, E.E., Ph.D.

A thoroughly readable, psychologically organized course, in two volumes, covering classical and modern physics at the intermediate level. It furnishes the background in physics required by all who desire to enrich their knowledge of science for individual and financial advancement. Every effort has been made to make the course self-teachable. Each illustration is carefully selected and executed. The books are rigorously correct technically, yet generate and maintain interest. Basic demonstration experiments are described and model problems are set up and solved. ≠195, both volumes in one cloth binding, 724 pp., illus. . . . only \$7.60

**ANNOUNCING TWO IMPORTANT NEW RIDER BOOKS ...**

**HOW TO READ SCHEMATIC DIAGRAMS**

by David Mark

Covering the symbols and abbreviations used in schematic diagrams related to the electronics field, this book starts with individual components and carries through to receivers and similar equipment. Components and circuits are identified and explained.

Soft cover, approx. 160 pp., 5 1/2" x 8 1/2", illus. . . .

≠208 . . . . . \$3.50

**REPAIRING HI-FI SYSTEMS**

by David Fidelman

This book deals with finding the troubles and repairing faults in hi-fi equipment with no test instruments—simple equipment—and elaborate equipment.

Typical troubles are analyzed and repaired through a system of logical steps. This book is broad in scope, yet maintains a simplified level. Soft cover, approx. 170 pp., 5 1/2" x 8 1/2", illus. . . .

≠205 . . . . . \$3.90

**INCREASE YOUR KNOW-HOW WITH THESE RIDER BOOKS ...**

- TV Picture Tube-Chassis Guide**  
by Rider Lab Staff  
≠204, soft cover, 68 pp. . . . . \$1.35
- Marine Radiotelephone Permit Q & A Manual (3rd class operator)**  
by Milton Kaufman  
≠206, soft cover . . . . . \$1.35
- Energy**  
by Sir Oliver Lodge, F.R.S.  
≠200, soft cover, 64 pp. . . . . \$1.25
- Getting Started in Amateur Radio**  
by Julius Berens W2PIK  
≠199, soft cover, 136 pp. . . . . \$2.40
- Hi-Fi Loudspeakers & Enclosures**  
by Abraham D. Cohen  
≠176, MARCO cover, 360 pp. . . . . \$4.60
- ≠176H, cloth bound . . . . . \$5.50
- How to Service Tape Recorders**  
by C. A. Tuthill  
≠167, soft cover, 160 pp. . . . . \$2.90
- Basic Vacuum Tubes & Their Uses**  
by Rider & Jacobowitz  
≠171, soft cover, 208 pp. . . . . \$3.00
- ≠171H, cloth bound . . . . . \$4.50
- How to Use Meters**  
by John F. Rider  
≠144, soft cover, 144 pp. . . . . \$2.40
- Fundamentals of Transistors**  
by Leonard Krugman  
≠160, soft cover, 144 pp. . . . . \$2.70
- Introduction to Color TV (2nd Edition)**  
by Kaufman & Thomas  
≠156, soft cover, 160 pp. . . . . \$2.70
- How to Select and Use Your Tape Recorder**  
by David Mark  
≠179, soft cover, 148 pp. . . . . \$2.95
- Television — How it Works (2nd Edition)**  
by J. Richard Johnson  
≠101, leather finish MARCO, 352 pp. . . . . \$4.60
- ≠101H, cloth bound . . . . . \$5.50
- Repairing Television Receivers**  
by Cyrus Glickstein  
≠191, soft cover, 212 pp. . . . . \$4.40
- Transistor Engineering Reference Handbook**  
by H. E. Marrows  
≠193, cloth bound, 9x12", 288 pp. . . . . \$9.95

- HOW TO INSTALL & SERVICE INTERCOMMUNICATION SYSTEMS** by Jack Darr  
≠189, soft cover, 152 pp. . . . . \$3.00
- SERVICING TV AFC SYSTEMS**  
by John Russell, Jr.  
≠192, soft cover, 128 pp. . . . . \$2.70
- SERVICING TV VERTICAL & HORIZONTAL OUTPUT SYSTEMS** by Harry Thomas  
≠150, soft cover, 176 pp. . . . . \$2.40

**ELECTRONICS TECHNOLOGY SERIES**  
edited by Alex. Schure, Ph.D., Ed.D.

- ≠166, RC & RL Time Constant, \$.90
- ≠166-2, FM Limiters & Detectors, \$.90
- ≠166-3, Frequency Modulation, \$.90
- ≠166-4, Crystal Oscillators, \$1.25
- ≠166-5, A-M Detectors, \$1.25
- ≠166-6, Limiters & Clippers, \$1.25
- ≠166-7, Multivibrators, \$.90
- ≠166-8, R-F Transmission Lines, \$1.25
- ≠166-9, Amplitude Modulation, \$1.25
- ≠166-10, Blocking Oscillators & I-F Amplifiers, \$.90
- ≠166-11, Wave Propagation, \$1.25
- ≠166-12, Superheterodyne Converters & I-F Amplifiers, \$.90
- ≠166-13, L-C Oscillators, \$1.25
- ≠166-14, Antennas, \$1.50
- ≠166-15, Inverse Feedback, \$.90
- ≠166-16, Resonant Circuits, \$1.25
- ≠166-18, D-C Circuit Analysis, \$1.35



FREE! Handsome genuine leather, gold-stamped bookmark, if you write today for FREE 1957 Catalog RE-II.

Buy these and many other RIDER BOOKS at your electronics parts jobber, book store or department store book department. Look for the Rider Bookseller.

If your favorite store does not sell the Rider books you want, order direct. Add state, city tax where applicable. Canadian prices 5% higher.



RADIO-ELECTRONIC CIRCUITS (Continued)

the opener can be operated instantly from the same switch. Moreover, it is impossible for current to flow through the solenoid for a period longer than that required to open the door. This prevents an excessive duty cycle and keeps the opener coil from overheating.

The circuit connects to the ac line supplying the garage light. The connection can be made through an extension cord run from an adapter in the light socket. With this unit, the opener is operated by switching the light on, then off and then on again within a few seconds. The second time that the light is switched on, the opener solenoid receives a 117-volt ac pulse of sufficient length to open the door, but not longer, even though the light remains on. Successive operations of the switch will not operate the solenoid if the on-off interval is longer than several seconds.

Here's how it operates: When the dpdt 115-volt ac relay (RY1) closes (with each closure of the light switch), the lower set of contacts allows C1 to charge from the selenium rectifier. When RY1 is released seconds later by

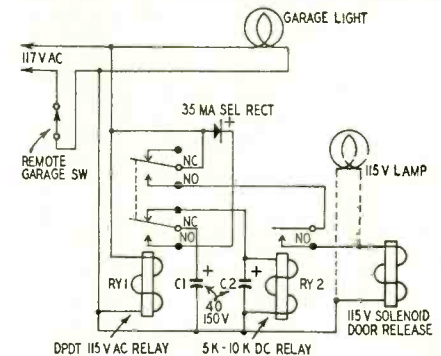

turning off the light, the normally closed contacts connect the charged capacitor (C1) across C2 and the coil of dc relay R2. RY2 now closes and remains closed until most of the charge on C2 has leaked off through its high-resistance coil. (The period that RY2 remains closed is determined by its coil resistance and armature spring tension and the capacitance of C2.)

The solenoid will not operate if the light switch is kept off until after RY2 opens. But, if the switch is closed before RY2 opens, line voltage is applied to the solenoid through the closed contacts of RY1 and RY2 in series. Line voltage cannot remain on the solenoid for any great length of time because RY2 opens when most of the charge has leaked off C2. The circuit through the solenoid remains open until the control is triggered again by flipping the light switch off and on again. A low-wattage 115-volt pilot lamp may be connected across the solenoid as shown by dashed lines to indicate a malfunction such as sticking contacts on RY2 which will keep the voltage applied to the solenoid.—Bruce Morrisette

**IMPROVISED IMPULSE RELAY**

During experimental or developmental work we may need a ratchet or impulse type relay to open or close

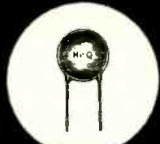

DISKS



TUBULARS



FEED-THRU



STAND-OFFS

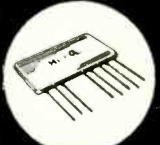
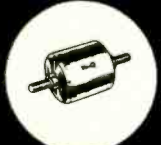

PLATE ASSEMBLIES



HIGH-VOLTAGE CARTWHEELS

You can do a **BETTER** job **FASTER** when you use...

# AEROVOX CERAMIC CAPACITORS

You can be sure that AEROVOX Ceramic Capacitors are exactly right for your service applications because of the extra-care taken in the manufacturing of these capacitors to provide you with trouble-free, exact-duplicate replacements. This extra-care assures your customers of stay-put installations saving you time and money on costly call-backs.

The AEROVOX line of ceramic capacitors is the most complete on the market. A type for every application is available to you for prompt delivery from the complete stock selection carried by your local AEROVOX Distributor.



**AEROVOX CORPORATION**

DISTRIBUTOR DIVISION  
NEW BEDFORD, MASS.

In Canada: AEROVOX CANADA LTD., Hamilton, Ont.  
Export: Ad Auriema, Inc., 89 Broad St., New York, N. Y.  
Cable: Auriema, N. Y.

NOVEMBER, 1957

## RADIO-ELECTRONIC CIRCUITS (Continued)

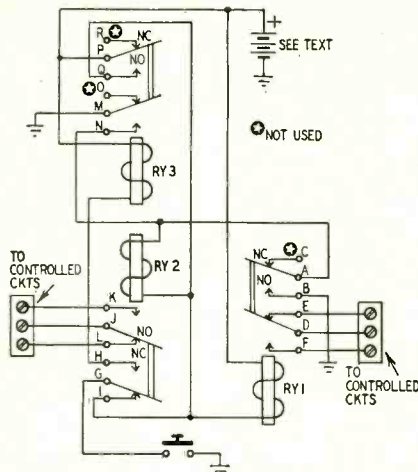

NC= NORMALLY CLOSED CONTACTS; NO= NORMALLY OPEN CONTACTS (COIL NOT ENERGIZED)

a circuit the first time a current is pulsed through its coil and reverse the circuit connection on the next input pulse. These relays are seldom available immediately. The diagram shows how you can substitute three ordinary dpdt relays of the type usually found in the junkbox and on the surplus market. This circuit is cumbersome and should be replaced by the correct relay when available. It is the electro-mechanical equivalent of a vacuum-tube or transistor flip-flop.

Spdt contacts available for controlling exterior circuits are D-E-F and J-K-L of RY1 and RY2, respectively. Contacts M-O of RY3 can be used to connect and disconnect a circuit from ground.

Upon closing the pushbutton—or similar momentary switch—the coil of RY1 is energized by current flowing through the switch and contacts G-I of RY2. This closes contacts A-B and auxiliary contacts D-F.

When the switch is released, current now flows to ground through A-B and the coils of RY1 and RY2 to the battery. RY1 and RY2 lock in through A-B. Contacts G-H and J-K are closed.

When the switch is closed for the second time, the coil of RY3 is energized through contacts G-H. Circuit P-Q closes and shorts the coil of RY1, opening A-B and D-E. RY2 is locked in momentarily through M-N which closes before A-B opens.

As soon as the switch is released, RY3 opens, breaking contacts P-Q and M-N and removing all excitation and grounds from the coils of RY1, 2 and 3. All auxiliary or control contacts have now been returned to their original positions and the circuit is ready for another cycle.

For proper operation, contacts M-N must be adjusted for a narrower gap than the others so they (M-N) close before A-B opens. The dc resistance or ac impedance—depending on the type of power supply—of the coils of RY1 and RY2 should be equal. The resistance or ac impedance of RY3's coil should be twice the value of the coil in RY1 or RY2. The battery (or ac supply) voltage is determined by relays used. END

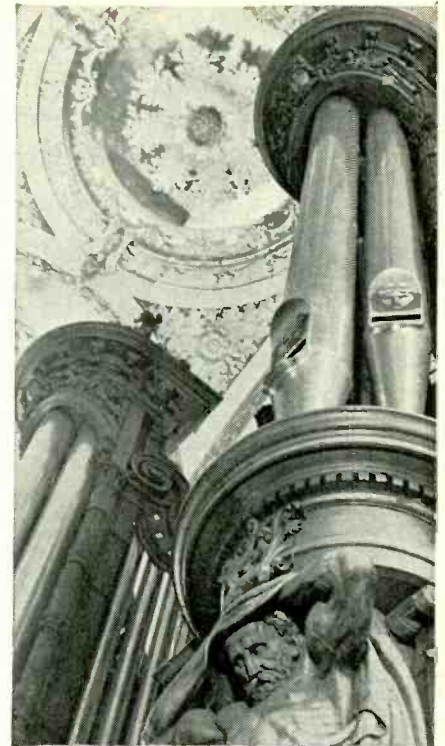

The "King of Instruments"—an Aeolian-Skinner organ installation.

THE sound of the organ is one of the most difficult to reproduce, because of its wide tonal and dynamic range, and because of the large amount of fundamental energy that appears at extreme bass frequencies.

At a recent public demonstration, staged by the Audio League at St. Mark's Church, Mt. Kisco, N. Y., the recorded sound of an Aeolian-Skinner organ (from stereo tape) was instantaneously alternated with that of the "live" instrument. The reproducing equipment selected included four AR-1 speaker systems. Here is some of the press comment on the event:

### The Saturday Review (David Hebb)

"Competent listeners, with trained professional ears, were fooled into thinking that the live portions were recorded, and vice versa... The extreme low notes were felt, rather than heard, without any 'loudspeaker' sound..."

### AUDIO (Julian D. Hirsch)

"Even where differences were detectable at changeover, it was usually not possible to determine which sound was live and which was recorded, without assistance from the signal lights—facsimile recording and reproduction of the pipe organ in its original environment has been accomplished."

### audiocraft

"It was such a negligible difference (between live and recorded sound) that, even when it was discerned, it was impossible to tell whether the organ or the sound system was playing!"

The price of an AR-1 two-way speaker system, including cabinet, is \$185.00 in mahogany or birch. Descriptive literature is available on request.

**ACOUSTIC RESEARCH, INC.**  
24 Thorndike St., Cambridge 41, Mass.

# SAMS "BEST SELLER" BOOKS

FOR THE TECHNICIAN • STUDENT  
EXPERIMENTER • HOBBYIST



## USE THIS HANDY ORDER FORM

**Pinpoint TV Troubles in 10 Minutes.** Amazingly practical procedures for solving TV troubles. Includes over 50 time-saving check charts, dozens of diagrams and test Methods, circuit explanations, etc.—a real timesaver for TV repairs. 299 pages; 5½ x 8½"; fully illustrated. Only ..... **\$3.95**

**TV Servicing Guide.** Quick reference guide for Technicians. Trouble symptoms are illustrated by picture tube screen photos and proper repair procedures are clearly described. Covers all sections of the TV circuit. 132 pages; 8½ x 11"; illust. Only ..... **\$2.00**

**Tape Recorders.** Explains recorder theory, tape characteristics, how recorders work; covers motorboard mechanisms, drive motors, volume indicators, bias oscillators, amplifiers, magnetic heads, equalization circuits. 176 pages; 5½ x 8½"; illust. Only ..... **\$2.75**

**Transistor Circuit Handbook.** The authoritative book on transistor types, construction, characteristics, applications, circuitry, techniques for wiring and testing. Covers every phase of the subject. 430 pages; 6 x 9"; illust. Only **\$4.95**

**Hi-Fi Handbook.** Invaluable data on Hi-Fi design, selection and installation, including fidelity, sound theory, analysis of all components (speakers, enclosures, amplifiers, tuners, etc.), systems design, proper selection and installation. 240 pages; 5½ x 8½"; illust. Only ..... **\$3.00**

**Servicing AGC Systems.** Describes operation and circuit variations of AGC systems; explains applicable servicing techniques. Illustrated by actual case histories and photos of symptoms. 132 pages; 5½ x 8½"; illust. Only ..... **\$1.75**

**Learning Electricity Fundamentals.** The complete, fascinating story of electricity: history, electron theory, static electricity, uses of switches and fuses, resistance, Ohm's Law, magnetism, electro-magnetism, transformers, generators and motors, circuits and controls, practical wiring, etc. 416 pages; 6 x 9"; illust. Only ..... **\$5.95**

**Transistors.** A very practical, complete book on Transistors and their application in TV-Radio-Electronics. Explains theory, circuitry, installation, testing techniques and servicing. 100 pages; 5½ x 8½"; illust. Only ..... **\$1.50**

**Color Television.** An outstanding training course for Technicians. Covers principles of the color TV system; color receiver circuits; installation and servicing of color receivers. Includes color blocks outlining use of color test equipment. 260 pages; 8½ x 11"; profusely illustrated. Only ..... **\$6.95**

**Electronic Metal Locators.** Explains basic types and their operation; tells how to construct your own units; describes applications. Covers interesting uses in industry as well as in prospecting and mine location. 124 pages; 5½ x 8½"; illust. Only ..... **\$2.50**

## HOWARD W. SAMS & CO., INC.

Order from your Parts Jobber, or mail to  
Howard W. Sams & Co., Dept. 2-L7  
2201 E. 46th St., Indianapolis 5, Ind.

Send books checked above. My (check) (money order)  
for \$..... is enclosed.

Name.....

Address.....

City..... Zone..... State.....

(outside U.S.A. priced slightly higher)

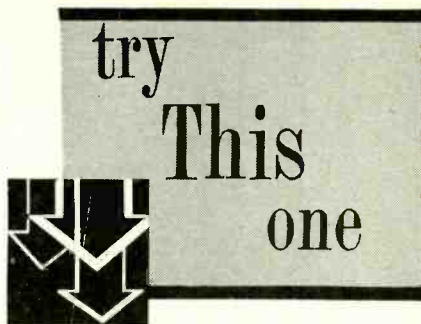

## TERMINAL MARKING

If you have ever lost or misplaced a wiring sketch that was drawn as a guide to the replacement of a defective component with many color-coded leads, you will appreciate this convenient method of marking circuit terminals.

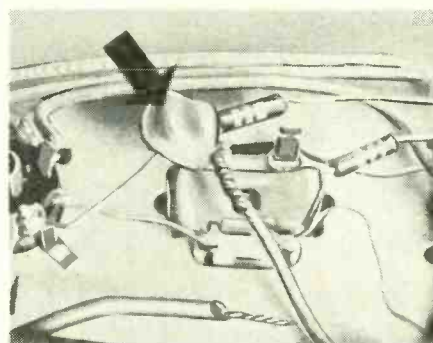

Keep a block of multicolored modeling clay on the bench and whenever you unsolder a lead mark the terminal with a small piece of that color clay. Remove the clay as you solder new leads in place.

The clay speeds up the repair and can't possibly become mislaid or lost as a sketch could be.—*John A. Comstock*

## SERVICING AID

When a new set comes into the shop, I always look up the code number for my service manual and jot it down on the back of the chassis with a grease pencil. Whenever one of these sets comes in for repairs I can tell at a glance just what manual contains the reference data. This trick is handy in speeding up future repairs.—*Scot Mock*

## INDUCTANCE MEASUREMENT

Very often it is necessary to measure the inductance of unknown or home-made inductors. In most instances test equipment designed for this purpose, such as an impedance bridge, is not available.

The drawing shows a method of determining inductance values with an

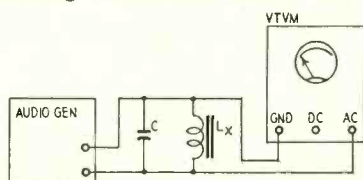

audio-frequency generator and a vtvm. The generator is set to provide an R-C-coupled high-impedance output and the vtvm is set to a low ac scale. With

## "OUTPERFORMS THEM ALL"



I. J. Saltzman, *Globe Sound Service, Jamaica, N. Y., experienced commercial sound engineer, says:* "On side by side comparison test, the CJ-44 outperforms them all."

## NEW! ATLAS "King Cobra-Jector" CJ-44



Shown with GB-1 Universal Mounting Bracket

Complete with "Acousti-Match" Built-in Driver Unit

List \$72.50  
**NET \$43.50**

A wide-angle, all-purpose, all-weather Public Address Speaker, complete with integral high-power super-efficient "Acousti-Matched" driver unit. "Acousti-Matched" means "Controlled Response" within the frequency limits most useful in P. A. and high level music reproduction. "Controlled Response" offers conversion efficiency never before obtainable in high-powered speakers. "Controlled Response" results in smooth reproduction — free from peaks which so often create and sustain acoustic feedback.

The CJ-44 conserves costly amplifier output power — fewer speakers do a complete job. The speaker horn is easily rotated for horizontal or vertical dispersion patters.

The CJ-44 is the only high-powered P. A. speaker that can be equipped with the new Atlas Universal Mounting Bracket, permitting quick and secure directional adjustment on both planes. Simple to make a horizontal or vertical adjustment as a final "touch-up" to the installation.

The CJ-44 is designed for the "tough jobs." No gimmicks, no fluffs, no wild claims — just a reliable super-efficient speaker for all applications.

Input Power:	30 watts constant 50 watts peak
Input Impedance:	16 ohms
Response:	150-9,000 cps
Dimensions:	Bell 23" x 13"; Over-all length 19"
Net Weight:	16 lbs.

Write for free Catalog 57.



# ATLAS SOUND CORP.

1443-39 St., Brooklyn 18, N. Y.  
Atlas Radio Ltd., Toronto, Canada



**TRY THIS ONE (Continued)**

the known capacitor (C) connected in parallel with the unknown inductor (L\*), the generator is tuned through its range until an indication is noted on the vtvm. At this point the tuning should be carefully adjusted and the frequency recorded on a sheet of paper. The value of capacitor C will depend on the tuning range of the generator and the range of inductance to be measured. Capacitor values for use with any frequency range and any range of inductance may be determined by the formula:

$$C = \frac{25,330}{fL}$$

where C is in microfarads (μf), L in henrys (h), and f is in cycles per second (cps).

The value of the measured inductance is determined by the formula:

$$L = \frac{25,330}{f^2 C}$$

—Michael S. Robbins

**SHOESTRING AS SPAGHETTI**

When I need some insulating spaghetti for low-voltage low-frequency applications, I use a length of shoestring. Since shoestring comes in several different widths and lengths and is hollow, it will fit most conductors. To insulate a wire, I simply select a shoestring of appropriate size, cut it to length, slip it over the wire and spray-insulate it with anti-corona dope. The resulting spaghetti is durable and has good insulating properties.—J. C. Alexander

**FUSE PULLER**

In many TV receivers the high-voltage fuse is located in the high-voltage cage and to technicians with big hands can sometimes prove to be a slippery article.

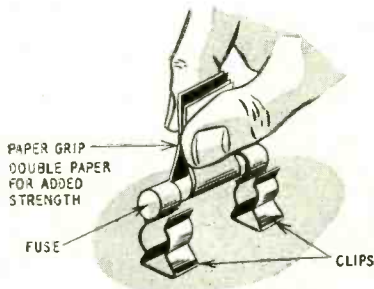

You can beat this problem by slipping a piece of heavy, brown paper around the fuse for a handle or grip as in the diagram.

Cut a strip just wide enough to fit between the fuse clips—about 3/4 x 5 inches. The fuse can be easily pulled or replaced using this paper handle. Keep a couple in your tool kit.—Frank W. Dresser

**RESISTOR REPAIRS**

Vitreous-enameled wire-wound power resistors with cracked or broken ceramic cores can be repaired satisfactorily if the resistance element is unbroken. In a bottle cap, mix a little iron cement (Smooth-On) according to directions.

**YOU NEED THIS...**

**FREE GIANT ALL NEW 1958 BA CATALOG**

A COMPLETE BUYING GUIDE FOR EVERYTHING IN **RADIO-TV ELECTRONICS**

**BA 1958 ANNUAL CATALOG 581 SINCE 1927**

**Guarantee**  
We guarantee everything in our Catalog to be of the quality and value represented. To conform exactly to the description and description in the manner and give the service intended for such purposes.

**RUSH COUPON TODAY!**

INDEX PAGE 170 PHONE BAIN

**BURSTEIN-APPLEBEE CO. Dept. M, 1012-14 McGee St., Kansas City 6, Mo.**

Send Free 1958 B-A Catalog No. 581.

NAME \_\_\_\_\_  
ADDRESS \_\_\_\_\_  
CITY \_\_\_\_\_ STATE \_\_\_\_\_

**TAPE RECORDERS**  
WHOLESALE PRICES  
**HI-FI COMPONENTS**  
NATIONAL BRANDS  
WRITE FOR FREE CATALOGUE

**CARSTON** 215 TD E. 88 ST. NEW YORK 28, N.Y.

**TAPE RECORDERS**

Tapes—Accessories  
Nationally Advertised Brands  
**UNUSUAL VALUES**  
Send for Free Catalog  
**DRESSNER**  
69-02 RE: 174 St. Flushing 65, N.Y.

**MERITAPE**  
Low Cost. High Quality Recording Tape—in boxes or cans.

**ENGINEERING**

Prepare for unlimited opportunities of the Electronic Age!

**B.S. DEGREE IN 27 MONTHS**

Earn your B.S. DEGREE IN 27 MONTHS in Aeronautical, Chemical, Civil, Electrical or Mechanical Engineering; in 36 MONTHS in Mathematics, Chemistry, Physics. Intensive, specialized courses. Comprehensive training in electronics, television, advanced radio theory and design, math, nuclear physics and elec. eng. Engineering Science preparatory courses. Low rate. Graduates in demand. Spacious campus; 20 bldgs., dorms, gym, playing field. Earn part of your expenses in Fort Wayne, G.I. approved. Enter Dec., March, June, Sept. Catalog

**INDIANA TECHNICAL COLLEGE**  
1711 E. Washington Blvd., Fort Wayne 2, Indiana

Please send me free information on B.S. ENGINEERING DEGREE IN 27 MONTHS as checked.

Electronics  Chemical  Aeronautical  
 Civil  Mechanical  Electrical

**B.S. DEGREE IN 36 MO. in: Math.  Chem.  Physics**

Name \_\_\_\_\_  
Address \_\_\_\_\_

# ARKAY

**It's NEW!**

**ARKAY FM-8**  
Professional  
Standard  
FM TUNER

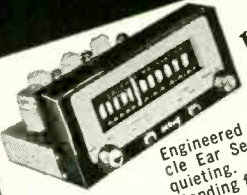

Engineered for precise FM reception Arkay "Miracle Ear Sensitivity" provides 1.9 uv for 20 db quieting. Freq. Response 20-20,000 cps. Outstanding features include 3 tuned RF stages, dual limiters, Armstrong FM Foster Seeley discriminator, variable AFC Silent tuning system, tuning meter, cathode follower, high-level & Binaural FM (multiplex) outputs, 0-100 log scale for station pinpointing, self-contained AC power supply plus many other extras.

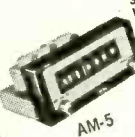

AM-5  
All IF's Factory  
Pre Aligned and  
Pre Set

**ARKAY AM-5 AM TUNER.** Most sensitive AM tuner. "Miracle Ear" 2 uv for 20 db s/n Wide & Narrow Band 3 gang tuning cond. 10Kc whistle filter.  
KIT \$39.95  
WIRED \$59.95

See and Hear  
the Fabulous  
**ARKAY**  
**STEREO HI-FI**

**KITS AND  
PREWIRED**



**ARKAY MODEL FL-30 HI-FI AMP PRE-AMP.** An engineering masterpiece TRANSISTORIZED front end assures finest in Hi-Fi sound, record equalization for more than 30 records. Freq. response: 1/2 db. 10-40,000 cps. @ 30 watts, 50 watt peak inputs for magnetic pickup, tuner, tape &

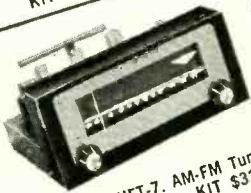

**ARKAY HFT-7 AM-FM Tuner.** AFC, Sensitive. KIT \$32.00  
WIRED \$49.95

**ARKAY FM-6 FM ONLY**  
KIT \$25.75  
WIRED \$39.95

2 aux. Complete with step-by-step plans, handsome black cabinet & rose gold panel.  
KIT \$49.95  
WIRED \$74.95

At Last! **"LIVING SOUND" STEREO**  
AT Sensible Prices  
by ARKAY



At last the economical audiophile can enjoy "living sound".  
**MODEL SA-25** - Just attach your present pre-amp to this dual channel pre-amp & 25 watt amp.  
KIT \$59.95  
WIRED \$89.95

**MODEL SP-6** - Dual channel pre-amp with cathode follower.  
KIT \$34.95  
WIRED \$47.95



**MODEL ST-11** - Binaural stereo tuner highly sensitive AM & FM reception.  
KIT \$47.95  
WIRED \$69.95

Prices 5% higher west of Mississippi  
FREE! At your dealer or write for complete catalogues of Stereo & Monaural HI-FI, Radio & TV, Kits & Wired.

**arkay 120 CEDAR STREET NEW YORK 6**

### OPPORTUNITY ADLETS

Rates—50c per word (including name, address and initials). Minimum ad 10 words. Cash must accompany all ads except those placed by accredited agencies. Discount, 10% for 12 consecutive issues. Misleading or objectionable ads not accepted. Copy for January issue must reach us before November 15, 1957.

**RADIO-ELECTRONICS,**  
154 West 14 St., New York 11, N. Y.

"FREE Cathode Ray Tube and telephone Dial with 100 pounds surplus electronic parts and equipment \$9.95. 4 jumbo 4-pin transmitting tube sockets only \$1. No C.O.D.'s. ALPINE PRODUCTS, Dept. 11A, 2236 Hepburn, Dayton 6, Ohio."

CASH PAID! Sell your surplus electronic tubes. Want unused, clean transmitting, special purpose, receiving, TV tubes, magnetrons, klystrons, broadcast, etc. Also want military & commercial lab test and communications gear. We swap too, for tubes or choice equipment. Send specific details in first letter. For a fair deal write, wire or telephone: BARRY, 512 Broadway, New York 12, N.Y. Walker 5-7000.

HIGH-FIDELITY SPEAKERS REPAIRED. AMPRITE Speaker Service, 70 Vesey St., New York 7, N.Y. BA 7-2580.

20-50% DISCOUNTS on Hi-Fi, tape recorders, tape, accessories, photographic equipment, individual quotations only. No catalogs. CONMAR CAMERA & HI-FI, 121-07 237th Street, Rosedale 22-1L, N. Y.

WANTED: Electronics men to qualify for Engineering Degree equivalence by comprehensive examination. No courses. Excellent employment opportunities waiting. CRAWWELL INSTITUTE, RE-7, Adams, Mass.

DIAGRAMS FOR REPAIRING RADIOS \$1. Television \$2. Give make, Model. DIAGRAM SERVICE, Box 672-RE, Hartford 1, Conn.

6199 Photo Multiplier Tubes \$20. Tubes and 1 1/2" X1" Sodium Iodide Crystals \$55. A-TRONIC LABS INC., Box 6216, Lakewood, Calif.

1000 Embossed Business Cards Raised Printing \$4.50 Postpaid. BROOKSIDE PRESS, Wonder Lake, Ill.

ALL MAKES OF ELECTRICAL INSTRUMENTS AND TESTING equipment repaired. HAZELTON INSTRUMENT CO. 128 Liberty Street, New York, N.Y.

PHONOGRAPH RECORDS cheap, postpaid. Catalogue. PARAMOUNT, Box 242-R, Williamsport, Penna.

TRY THIS ONE (Continued)

Run a bolt through the resistor with a washer on each end and tighten the nut just enough to hold the broken pieces in place. Apply the iron cement over the break and let it harden before removing the bolt.

This method is better than using a bolt alone to make the repair because it does not interfere with the circulation of cooling air through the resistor. Keep the patch above ground because some of the conductive cement may be touching the wire element.—  
D. R. Frank

### TRANSISTOR BATTERIES

Battery packs salvaged from personal type portable radios are handy when experimenting with transistors. The small wafer cells can be reassembled to provide almost any voltage likely to be needed for transistor projects.  
—T. Clark

### PREVENT HEAT DAMAGE

Experimenters know that during soldering pliers should be used to absorb the heat on the leads of delicate components. However, it's sometimes

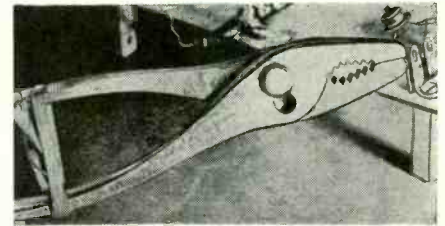

difficult to hold the pliers and do the soldering job too. The pliers will hold themselves in place when they are snapped around the lead if a rubber band is stretched around the handles.  
—Hugh Lineback

### CARBON TET FUMES

In our shop we use a 10-inch electric fan to dissipate the fumes of carbon tetrachloride, contact cleaner and other dangerous chemicals. The fan is kept close to the chassis being serviced so it dissipates the fumes before the technician can detect the odor.—Seymour Winterfeld  
END



"It was so nice of you to invite George and me over for bridge!"

# Technotes

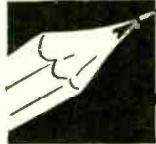

## WEAK OR NO COLOR

A fairly common cause of weak or no color in the RCA 21-CT-663U is R240, normally 560 ohms, increasing in value and cutting down grid 2 voltage at V123. Every time this trouble has come up, we have found an inter-

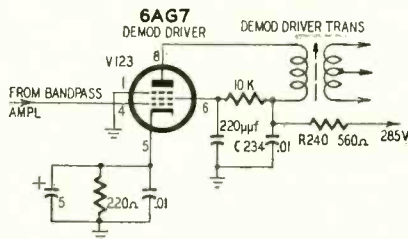

mittent short in the tube or in C234, a .01- $\mu$ f capacitor. We now change both the tube and capacitor any time R240 has changed value. Apparently the short causes an excessive flow of current through the resistor, heating it enough to change its value.—*Warren Roy*

## G-E 805

Complaint, no picture, no sound, no raster, no nothing. This could be anywhere, but most probably low-voltage B or filament supply.

All tubes were lit. With such a group of symptoms there are but few remaining causes for no picture, no sound, no raster.

There were no visible signs of any part being overheated, burned or shorted, but I looked carefully for an open. I knew there was ac coming into the chassis because the tubes were heated. Tracing the ac line, I found it branching to the filaments and to the rectifier circuit at the line switch. (The switch and a thermal cutout are in series, common to filaments and selenium rectifiers.)

The 5-ohm resistor in the rectifier branch was open. This is a 4-watt, wirewound unit. I replaced it with a 5-ohm 10-watt, wirewound resistor. Whenever a wirewound resistor in a power supply goes, it is the better part of servicing discretion to replace it with one having twice the wattage rating of the original component.—*David T. Armstrong*

## ZENITH Z-2222C

Trouble was narrow picture and decreased brightness. We found that the grid voltage of the horizontal output tube (6DQ6) was 38 volts negative instead of the rated -45.

The set has a fixed input network to the output tube with no means of in-

# QUAM

Adjust-a-Cone<sup>®</sup>

## SPEAKERS

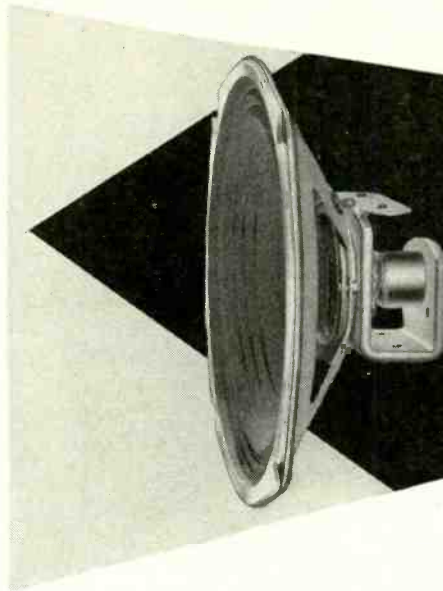

are the  
**SAME PRICE**  
but they  
**COST LESS**

They cost less because they fit right . . . the first time . . . and they work right . . . the first time.

With Quam Adjust-a-Cone Speakers there are no callbacks—caused by defective or non-fitting speakers—to eat up your profits.

Remember: a guarantee does not pay for your time or protect your reputation and customer goodwill . . . so use Quam, the "no-callback" speaker.

ask for QUAM,  
the quality line,  
for all your speaker needs

## QUAM-NICHOLS COMPANY

236 EAST MARQUETTE ROAD • CHICAGO 37, ILLINOIS

### OPPORTUNITY ADLETS (Continued)

LOOKING FOR CLEAN RESPONSE to 20 Cycles? Listen to the radically new "Racon Hi-C" foam suspension speaker. Write for free literature. RACON ELECTRIC CO., INC., 1261 Broadway, N.Y. 1, N.Y.

TELEVISION Tuner Repairs. DAN'S TELEVISION LABORATORY, 606 Sunrise Highway, Babylon, N.Y.

COMPLETE Television Sets \$11.95. JONES TV, 1115 Rambler, Pottstown, Pa.

LEARN WHILE ASLEEP! Details free. RESEARCH ASSOCIATION, Box 610-RE, Omaha, Nebraska.

RECORDERS, Hi-Fi, Tapes. Free Wholesale Catalogue. CARSTON, 215-T East 88th St., New York 28, N.Y.

PROFESSIONAL Electronic Projects—Organs, Timers, Intercoms, Counters, etc. \$1 each. List Free. PARKS, Box 946 Redwood City, Calif.

LONG PLAYING RECORDS 20 to 50% Discount Brand-New Factory Fresh Unplayed—All Labels—Send 20c for catalogue to RECORD SALES, 1110 Winbern, Houston 4, Tex.

Patents, Copyrights. SANDERS, Registered Patent Attorney, 6430 Evans, Chicago 37, Ill.

DIAGRAMS! Repair Information! Radios—Amplifiers—recorders \$1. Televisions \$1.50. Give make, model, chassis. TV MILITE, Box 101EA, Hicksville, N.Y.

SAVE! SAVE! The finest of Hi-Fi components and Records. All brand new. Write for free list today. DOWNEY HI-FI, P.O. Box 2065 Dept. "RE" Downey, Calif.

DISCOUNTS UP TO 50% except fair trade items—Cameras, projectors, tape recorders, lenses, Hi-Fi components. Write for individual quotations on your specific needs, no catalogs. CLASSIFIED HI-FI EXCHANGE RE, 2375 East 65th St., Brooklyn 34, N.Y.

TAPE recorders, tape. Unusual values. Free Catalog. DRESSNER, 69-02RT 174 Street, Flushing 65, N.Y.

LABORATORY QUALITY equipment and Military Surplus Electronics bought, sold. ENGINEERING ASSOCIATES, 434 Patterson Road, Dayton 9, Ohio.

HI-FI Amplifiers, Speakers, tape recorders turntables, Ham transmitters and receivers WRL, National Hallcrafters, Hammerland, Johnson and Collins. Easy terms. KEN-ELS RADIO SUPPLY, 428 Central Ave., Ft. Dodge, Iowa. 67-16th Ave. S.W., Cedar Rapids, Iowa.

UNUSUAL CONFIDENTIAL QUOTATIONS on all your "Hi-Fi" requirements. No Catalogs. KEY ELECTRONICS, 120 Liberty Street, N.Y. 6, N.Y. EVERgreen 4-6071.

PATENT DRAWINGS of your inventions. 35 years experience. Electronic diagrams to patent office requirements. PATENT SERVICE ASSOCIATES, Haverhill, New Hampshire

PORT ARTHUR COLLEGE—Training for FCC Licenses. Enrollment Monthly. PORT ARTHUR, Texas.

PRINTING PRESSES, Type, Supplies, lists 3c. TURNBAUGH SERVICE, Mechanicsburg, Pa.

# BENCO INTRODUCES ANOTHER TV LEADER!

## 5 VOLTS R. F.

Maximum output

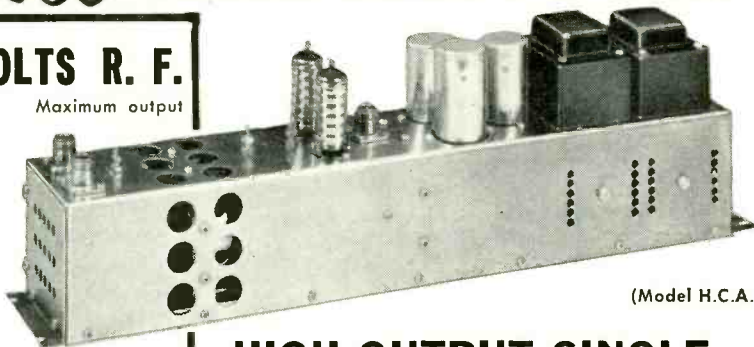

(Model H.C.A.)

- 20 db gain minimum
- 6 mc/s bandwidth
- Silicon Rectifier
- Available for Channels 2 to 13
- Will drive a low band signal through 2½ mi. of K-14 type cable

### WRITE TODAY

Benco Television Associates Ltd.,

- Please send me complete details on the H.C.A. Amplifier.
- Other Benco Equipment

Name.....  
Address.....  
City.....  
State.....

## HIGH OUTPUT SINGLE CHANNEL AMPLIFIER

PROVIDES THE HIGHEST OUTPUT OF ANY KNOWN TV CHANNEL AMPLIFIER

The H.C.A. amplifier is designed for use as a final amplifier in large hotel or apartment distribution systems where it is necessary to locate all the amplifying equipment in one room or floor.

It is also useful for driving a TV signal over a long run of co-axial cable through inaccessible terrain.

A commercial transmitting tube is used for the final stage to deliver the full-rated output without distortion.

Price \$250.00 Suggested User Net

### TECHNOTES (Continued)

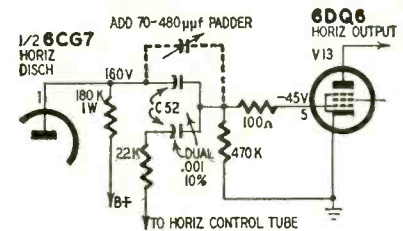

creasing the drive. A 70-480- $\mu$ f padder was connected across the series half of C52 (2 x .001  $\mu$ f, 10% dual) as shown in the diagram. The drive was adjusted with the padder and the trouble disappeared.

(The padder could have been connected from the control grid of the horizontal output tube to ground to cure excess drive.)—L. A. Williams

### WANDERING AGC

This color set, an RCA CTC5N, had a raster but no picture. Tube substitution in the rf, if and Y amplifier had no effect. We noted that normal operation was restored by adjustment of the agc threshold control. We let the receiver run for a while and the picture started to wash out. Replacement of the keyed agc tube did not help. Resetting the threshold control did restore normal operation. We thought of leaky capacitors in the agc line, but before starting on those an audible arc from the high-voltage cage was heard, with the picture overloading.

With scope and low-capacitance probe to the plate of the keyed agc tube we were able to see the keying pulse taking a nose dive and then jumping back to more than its initial peak-to-peak voltage. The arc, if still present, was no longer audible.

We replaced the horizontal output transformer as the next logical step. After replacing the transformer the keying pulse remained stable, and the receiver has been operating for a month without further trouble.—Robert G. Middleton

### MOTOROLA TS902-A

The trouble was loss of horizontal dynamic convergence. No response was obtained by adjusting the horizontal dynamic amplitude controls.

Visual inspection showed that lead A (see diagram) had broken loose from

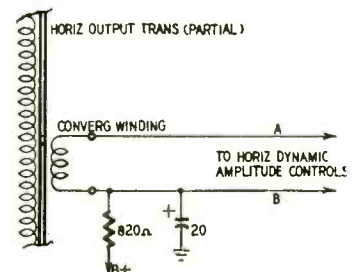

its joint at the blue amplitude control. The lead was resoldered, but still no response was obtained when the amplitude controls were varied.

A scope check across A and B showed only a 60-cycle parabola, which was being fed through from the vertical

**BENCO** TELEVISION ASSOCIATES LTD.  
27 TABER ROAD, REXDALE, ONTARIO, CANADA

Only from famous COYNE do you get this modern up-to-the minute TV Home Training. Easy to follow instructions—fully illustrated with 2150 photos and diagrams. Not an old Radio Course with Television tacked on. Includes UHF and COLOR TV. Personal guidance by Coyne Staff. *Practical Job Guides* to help you EARN MONEY QUICKLY IN A TV-RADIO SALES AND SERVICE BUSINESS—part time or full time. COSTS MUCH LESS—pay only for training—no costly "put together kits."

### SEND COUPON FOR FREE BOOK

SEND COUPON BELOW for Free Book and full details including EASY PAYMENT PLAN. NO COST OR OBLIGATION—NO SALESMAN WILL CALL.



B. W. COOKE, Jr., Pres. **COYNE** ELECTRICAL SCHOOL FOUNDED 1899

A TECHNICAL TRADE INSTITUTE OPERATED NOT FOR PROFIT  
500 S. Paulina, Dept. 87-HT4, Chicago 12, Illinois

COYNE ELECTRICAL SCHOOL  
Television Home Training Div.  
500 S. Paulina St., Chicago 12, Ill., Dept. 87-HT4  
Send FREE BOOK and details of your Television Home Training offer.

Name.....  
Address.....  
City..... State.....

## SENCORE Handy "36" R-C Substitution Unit

Another Sencore Time-Saver

"36" Most Often Needed Components At YOUR Fingertips!

3 pole, 12 position switch individually selects one of the "36" components for direct substitution.

Contains:

- ★ 12-1 watt 10% resistors from 10 ohms to 5600 ohms
- ★ 12-½ watt 10% resistors from 10K ohms to 5.6 megohms
- ★ 10-600 volt capacitors from 100-mfd. to .3mfd.
- ★ 1-10mfd., 450V Electrolytic
- ★ 1-40mfd., 450V Electrolytic

★ For Shop, Lab, or outside service AVAILABLE AT ALL PARTS DISTRIBUTORS!

ONLY \$1275 DEALER NET

POPULAR SENCORE PRODUCTS

- Transistor Tester
- Leakage Checker
- Filament Tester
- Voltage Regulator
- Bias Supply

**SERVICE**  
INSTRUMENTS CORP.  
171 OFFICIAL RD., ADDISON, ILL.

Cut out this ad now for further information.

convergence system. Leads A and B were then disconnected and the scope check repeated. Now an apparently normal pulse output was obtained. This was a bit of a puzzler.

Then an ohmmeter check was made of the convergence winding. Infinite resistance was indicated. The winding was open, but the pulse waveform was observed on the scope screen because the scope has such high input impedance that the capacitive coupling across the open was sufficient to drive it.

When starting to replace the flyback, we observed that the fine wire lead from the convergence winding was melted externally. Another lead was run from the terminal on the flyback board to the coil end, and the system took off and worked normally.

The lead had become fused because B-plus voltage is applied to the convergence winding and the broken lead at the amplitude control had shorted to chassis ground. Fortunately, the winding did not melt inside the coil, so flyback replacement was unnecessary.—*R. M. Centerville*

### POOR COLOR SYNC

Last week we had an RCA 21-CT-660U pulled into the shop for poor color sync. With a color program on the air, perfectly normal color saturation

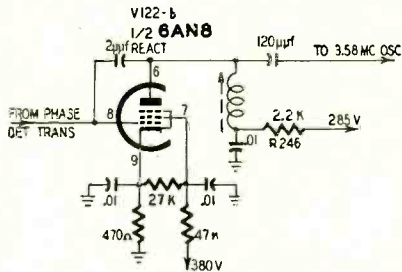

would be present, but the color would just wander. A careful check through the circuit revealed that the V122B, the reactance tube, had low plate voltage. Further checks showed that a 2,200-ohm plate resistor R246 had gone up in value to 3,500 ohms. A quick replacement and everything was back to normal.—*Mark Surgeon* END



## CHRISTMAS COMES EARLY AT LEKTRON!

DOUBLE VALUE FOR YOUR MONEY IN OUR

# 5 & 10 SALE!

**FREE \$5 WORTH OF RADIO PARTS WITH ANY \$5 TO \$9 ORDER!**

**FREE \$10 WORTH OF RADIO PARTS WITH ANY \$10 ORDER plus YOUR CHOICE OF ANY \$1 ITEM FREE WITH EVERY \$10 ORDER!**

ANY ORDER ENROLLS YOU IN OUR CREDIT-BONUS PLAN!

**FAMOUS DOLLARBUYS! SOLD AND GUARANTEED ONLY BY LEKTRON**

- 60 TRANSFORMERS. Reg. \$15. 1P. RF. anti-slug-tuned coils. chokes. 25 types. Wt. 3 lbs. **\$1**
- 5 LBS. HARDWARE. Reg. \$8. Approx. 2000 pcs. Ass'd. screws, blackets. **\$1**
- 40 HI-Q CONDENSERS. Reg. \$8. Ceramic, tubular cases. Assorted values. **\$1**
- 2 TRANSISTOR TRANSFORMERS. Reg. \$10. UTC "Gunner" type. Inter-stage. 1 x 8 1/2 x 3/4". Imp. ratios. Unknown. Color-coded leads. **\$1**
- WORLD'S SMALLEST RADIO KIT. Reg. \$3.50. 214 x 154 x 3/4". w/ permeability tuner, diode. All parts, directions. **\$1**
- 20 ASSORTED BULBS. Reg. \$3. Min. screw & bayonet to 6V. Wt. 1/2 lb. **\$1**
- EMERSON TUNER. Reg. \$5. Hi-Q permeability tuned ANT & OSC coils w/ paddlers on 2 x 4" plate; variable tuning mech. 500 to 1600 Kcs. **\$1**
- SURPRISE KITS/COMP! Reg. \$15. Wide assortment, resistors, condensers, term. strips. Approx. 150 **\$1**
- 175 FT. HOOKUP WIRE. Reg. \$3.75. In 25-ft. rolls. Ass'd. colors, stranding, insulation. **\$1**
- 24. Wt. 2 lbs. **\$1**
- "Postage stamp" CRYSTAL MIKE. 3/4" sq. Crisp. clear to 8,000 cps. **\$1**
- 60 RESISTORS. Reg. \$18. Insulated. Many 1/2 & 3/4" to 2 W. 10 ohms to 10 megs. 30 values. Wt. 1/2 lb. **\$1**
- SUB-MINI PNP TRANSISTOR. 1/2 pencil eraser size, used in "name" mfg. brackets. Elsewhere. \$3 value. **\$1**
- S1STOR. 1/2 pencil eraser size, used in "name" mfg. brackets. Elsewhere. \$3 value. **\$1**
- 2 SUB-MINI SOLENOIDS. Reg. \$5. 1 x 5/8 x 5/8". Change elec. energy to mech. 12 VDC @ 300 ma actuates plunger. Wt. **\$1**
- TEN 3-SEC. TIMING MECHANISMS. Reg. \$3 each. V. geared for all kinds of gadgets. Wt. 2 lbs. **\$1**
- SUB-MINI I.F. TRANSFORMERS. Reg. \$2. sq. double-ended, tuned ferrite cores. 5 terms. Transistor. printed circuit hobbyists, note! **\$1**
- 60 TUBULAR CONDENSERS. Reg. \$12. 0002 to 1 mi. to 2000 V. Oils incl. Wt. 2 lbs. **\$1**
- 30 TUBE SOCKETS. Reg. \$3. 1/2" printed circuit, 4-14 prong, mini, standard types. Some mica filled. Wt. 1 lb. **\$1**
- 8 TRANSISTOR SOCKETS. Reg. \$3. Mica-filled. For sub-mini tubes, too. **\$1**
- 40 MOLDED CONDENSERS. Reg. \$8. Black beauties, porcelain, etc. Oils, too. To 1 mf; to 1000 V. Wt. 2 lbs. **\$1**
- 40 TRANSISTOR RESISTORS. Reg. \$6. Only 1/2" long. 20 values: 15 ohms to 10 megs. Color. **\$1**
- 4 OUTPUT TRANSFORMERS. Reg. \$6. 50L6, 65L6, 6V6, 60B4 to 3-4 ohm v.c. Wt. 1 lb. **\$1**
- 8-PC. NUTDRIVER SET. \$3 value. Plastic handle, 3/16, 7/32, 1/4, 5/16, 11/32, 3/8, 7/16" steel socket wrenches in plastic case. Wt. 1 lb. **\$1**
- 15-PC. TWIST DRILL SET. Reg. \$4. 1/16 thru 1/4" by 6ths in graduated plastic hold. **\$1**
- SIX DIODES. Reg. \$15. Ass'd. Precision, crystal & silicon. **\$1**
- 40 PRECISION RESISTORS. Reg. \$18. Carbonfilm, Wilkors, etc. 1/2" to 1 W. Ass'd. Wt. 1/2 lb. **\$1**
- 100 RADIO PARTS. Reg. value over \$15! Surprise assort. Wt. 3 lbs. **\$1**
- 30 TERMINAL STRIPS, POSTS. Wide variety solder lug, binding. Wt. 1 lb. **\$1**
- 30 DISC CONDENSERS. Reg. \$8. Transistor & printed circuit types. **\$1**
- 50 PLUGS & RECEPTACLES. Audio, power, chassis, panel & spkr. Ass'd. Wt. 2 lbs. **\$1**
- 60 MICA CONDENSERS. Reg. \$5. Silver, 50% incl. 30 values: 00001 to .01 mf. To 1000 V. Wt. 1 lb. **\$1**
- R/C CONTROL SCOOP! Chassis incl. 3000-ohm mini control relay, 115 to 6.3-1.5A fil. xfmr., resistors cond. pot., sockets. Wt. 2 lbs. **\$1**
- 30 POWER RESISTORS. Reg. \$8. WW, candohm, sand-rod, vitreous. 15 values: 5 to 50 W. 35 to 11000 ohms. Wt. 2 lbs. **\$1**
- 15 VOLUME CONTROLS. Reg. \$10. Singles, duals to 1 meg. Wt. 1 lb. **\$1**
- 20 PRINTED CIRCUITS. Reg. \$10. Ass'd. top makes, for transistor, radio, hobby circuitry. **\$1**
- 10 "POLY" BOXES. Reg. \$2.50. Ass'd. sizes, clear plastic hinged, w/ snap locks. **\$1**
- 125 RESISTORS. Reg. \$15. 1/2" W. 40 values: 5 ohms to 10 megs. 97%, too. **\$1**
- 10 IF TRANSFORMERS. Reg. \$15. Metal can ass'd. freqs. for radio. T/hobby use. Wt. 3 lbs. **\$1**
- 60 STANDARD KNOBS. Reg. \$9. Bakelite & plastic, ass'd. colors. Set-screw types, too. Wt. 2 lbs. **\$1**
- 10 ELECTROLYTICS. Reg. \$14. Ass'd. cylindrical types to 500 mf. Wt. 3 lbs. **\$1**
- 30 ROTARY SWITCHES. Reg. \$10. Ceramic & bakelite; 1, 2, 3-gangs. Std. shafts. Wt. 3 lbs. **\$1**
- 30 PRINTED CIRCUIT PARTS, BOARDS. Reg. \$17. Exclusive! Wide variety of useful parts. 100 boards, too. **\$1**
- 100 CERAMIC CONDENSERS. Reg. \$15. Ass'd. types, color-coded. Discs, too. **\$1**
- 15 ADJUSTABLE FERRITE COILS. Reg. \$12. Ass'd. types, sizes. Fresh. Wt. 1 lb. **\$1**
- 5 FERRI-LOOPSTICK CORES. Hi-Q, ass'd. flat & tubular; 5 to 7" long. Wt. 1.2 lbs. **\$1**
- 15 AC-DC CORD SETS. Reg. \$5. Heavy duty, 6 to 8 ft. less plugs. Ashbestos insulated. Wt. 3 lbs. **\$1**
- 60 PORCELAINIZED RESISTORS. Reg. \$12. Carbonfilm, precision type. 25 values: 1/2 to 1 W. 50 ohms to 1 meg. Wt. 1 lb. **\$1**
- FLEA-POWER MOTOR. Reg. \$15 to 3VDC. Needs only pen-lite cell. 3 to 6000 rpm. **\$1**
- HOBBY TRANSFORMER. Reg. \$6. 115VAC, 60 c. Supplies 300 VDC @ 60 ma. w/ multi fil. taps. Encased. 9V Battery, 69c extra. **\$1**

### PRE-CHRISTMAS SPECIALS!

- POCKET MULTI-TESTER**  
 \$13 value! 3 1/2 x 2 x 1 1/2" bakelite case, 100 ohms/V. Zero adj. 0/15/150/1000 AC & DC V; 0/150 max. 0/100,000 ohms. W/test leads. In orig. pack. **\$6.99**
- 100-200-300-power MICROSCOPE**  
 w/ slides. \$17.50 value. Top quality w/ precision ground achromatic lenses. **\$3.99**
- HI-FI TWEETER**  
 Metal cased, cone. Freq. resp. 3,000 to 10,000 cps. Two types: 8 ohm or 16 ohm imp. Max. rating, 20 W. 2 1/2 x 2 1/2" w/ flat surface mfg. brackets. Elsewhere. \$5.95 to \$12. **\$3.99**
- SUPER-SENSITIVE RELAY**  
 Reg. \$15. 100 to 500 micro-amps or 1/2 VDC SPDT cont. Makes nifty transistor amplified photo-electric relay (plans incl.) Hundreds of **\$2.98**
- 3-TUBE AC-DC AMPLIFIER**  
 Reg. \$5. Fully wired; sep. volume controls. Lowest price ever! **\$2.99**
- 12" HI-FI PM SPEAKER**  
 50 to 10,000 cps. Ivy Airco magnet, 3.2 ohm v.c. **\$3.99**
- TRANSFORMERS**  
 Choice of three, 20K to 1K; 10K to 2K c.t.; 500 c.t. to 3.2 ohms. Color-coded leads. EACH **\$1.49**
- CRYSTAL**  
 2,000 ohm **\$1.69**  
 5,000 ohm **\$1.89**
- TRANSISTOR ADD-A-STAGE**  
 Makes any crystal set into transistor radio, easily, quick. **\$1.99**
- TRANSISTOR PORTABLE RADIO KIT**  
 No experience necessary! Famous make, with powerful Hi-Q ferrite antenna, diode det. 2 transistor amp. stages, 4" spkr., 7 1/2 x 5 1/2" styrene case. For broadcast band. Instructions, diagrams, pictorials. **\$12.94** all parts. 9V Battery, 69c extra.

Check items wanted. Return entire ad w/check or MO, including sufficient postage; excess returned. C.O.D. orders, 25% down. Rated, net 30 days. Print name, address, amount money enclosed, in margin. (Canada postage: 45c 1st lb., 28c ea. add. lb.)

**LEKTRON**  
131 EVERETT AVE. CHELSEA 50, MASS.

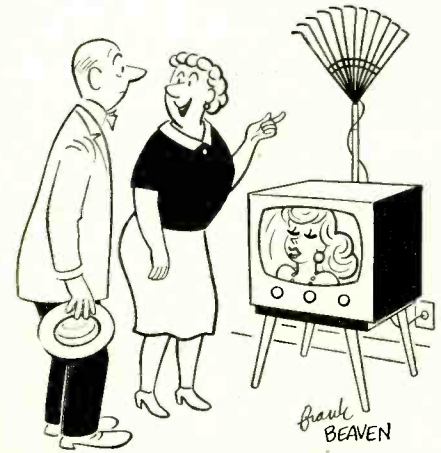

"It's our garden rake! I just hooked it up, and it works fine."

**ULTRA MAGNET**  
Lifts more than 20 times its own weight. Little Giant Magnet. Lifts 5 lbs. easily. Weighs 4 oz. Made of ALNICO new high-magnetic steel. Complete with keeper. World's most powerful magnet ever made. The experimenter and hobbyist will find hundreds of excellent uses for this high quality permanent magnet. Measures 1 3/4 x 1 1/2". Ship. Wt. 3/4 lbs. ITEM NO. 86 YOUR PRICE **\$1.50**

**250 POWER TELESCOPE LENS KIT**  
Make your own high powered 6 ft. telescope! Kit contains 2" diam., 75" focal length, ground and polished objective lens and necessary eye pieces. Magnifies 50x to 250x. Full instructions. ITEM NO. 123 **\$2.95** (Shp. Chgs. 10c)

**AMAZING BLACK LIGHT**  
250-watt ultra-violet light source. Makes fluorescent articles glow in the dark. Fits any lamp socket. For experimenting, entertaining, unusual lighting effects. Ship. wt. 2 lbs. ITEM NO. 87 **\$2.45** (P. P. & Hdig. Chgs. 35c)

**HUDSON SPECIALTIES CO.** 160 W. 14th St. Dept. RE 11-57, New York 7, N. Y.  
I am enclosing full remittance for items circled below. (Be sure to include shipping charges.)

87 33 86 123

Name \_\_\_\_\_ Please Print Clearly  
Address \_\_\_\_\_  
City \_\_\_\_\_ Zone \_\_\_\_\_ State \_\_\_\_\_

**WATT HOUR METER**  
Leading makes—reconditioned. Ideal for trailer parks. 100-110 volts, 60 cycles. 2-wire A.C. 5 amp. Heavy metal case 8 1/2" x 6 1/4" x 5". Easy to install. Ship. wt. 14 lbs. ITEM NO. 33 **\$4.50** NOW ONLY (P.P. & Hdig. Chgs. \$1.25)

# WHAT'S NEW IN HI-FI

## Grommes Little Genie

### KITS

New exclusive method  
"So simple . . . it's like magic".

- LAYER-BUILT
- COLOR-GUIDE

Write for details before  
you build another kit!



Before you build another kit see this new method of Kit Assembly. Each kit is complete with all parts and the new exclusive "Little Genie" Instruction Book.

LJ6-K—(Little Jewel) 10 Watt Amplifier with built-in preamplifier. Net. . . . . 24.95

207A-K—Hi-Fi Preamplifier (Self-Powered) Feedback circuit with 10 controls. Net. . . . . 44.50

250-K—60 Watt Basic Amplifier for use with a preamplifier (such as 207A-K). Net. . . . . 79.50

## NEW PG SERIES HI-FI AMPLIFIERS



### 20PG 20 Watt High Fidelity Amplifier

The new 20PG has greater flexibility of controls, new advanced circuitry and the highest quality components. Features: Feedback throughout, separate turnover and roll-off record compensators, new loudness control, wide range bass and treble controls, rumble and scratch filters and six inputs including tape head. Net Price. . . . . 89.50

15PG8 15 Watt High Fidelity Amplifier. Has less power but the same advanced circuitry, the highest quality components and greater flexibility of controls. Net Price . . . . . 69.50

10PG8 10 Watt High Fidelity Amplifier. Here is new styling with a full set of controls providing exceptional flexibility in a moderately priced amplifier. Net Price . . . . . 55.00

See your dealer or write . . .

**Grommes** Div. of Precision Electronics, Inc.  
Dept. RE-11, 9101 King Street, Franklin Park, Ill.

- Send details on "Little Genie" kits.
- Send Free Hi-Fi Equipment Brochure.

Name .....

Street .....

City ..... Zone ..... State .....

# Business and People

Triplett Electrical Instrument Co., Bluffton, Ohio, in conjunction with its advertising agency, Burton Browne, Chicago, developed a new package for

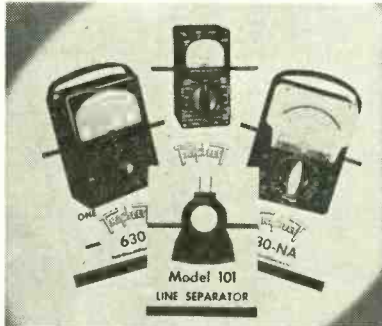

its vom's and vtm's. Each carton features a life-size photo of the unit for easy identification.

Orradio Industries, Opelika, Ala., is



now marking its acetate-base long play tape in a distinctive new box.

Charles Golenpaul (top left), vice president of Aerovox Corp., was elected president of the Electronic Industry Show Corp., sponsor of the Electronic Parts Distributors Show. Mauro E. Schifino (top right), Rochester Radio



Supply, was elected vice president; Lew W. Howard (bottom left), Triad Transformer Corp., secretary, and Roy S. Laird (bottom right), Ohmite Manufacturing Co., treasurer.

Pyramid Electric Co., North Bergen, N. J., announced the top winners in its recent Twist-Mount Capacitor Contest. R. Berthold, Springfield Gardens, N. Y., won the grand prize, a weekend for

Columbia

# Contro-Roller

# STOPS

TV KNOBS FROM  
TURNING TOGETHER

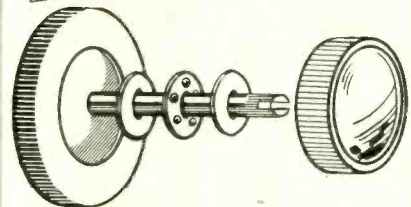

Twenty-five million TV sets in America have two knobs on one shaft (concentric controls). The two knobs usually turn together — in fact it is often impossible to turn one knob without the other knob turning with it. Contro-Roller stops this!

- ★ Simple Half Minute Installation  
Any set owner can do-it-himself without tools.
- ★ High Quality Precision Bearings
- ★ Simple to Display
- ★ Easy to Sell

Catalog No. 888  
DISPLAY CARD  
OF 24 PACKAGES

Every Service Dealer should have a display card of 24 Contro-Roller sets on his counter!

WRITE FOR COMPLETE CATALOG TODAY!



AVAILABLE AT ALL LEADING DISTRIBUTORS

Columbia  
**WIRE & SUPPLY CO.**  
2850 IRVING PK. RD., CHICAGO 18

**DECEMBER**  
**RADIO-ELECTRONICS**  
with the  
**ANNUAL INDEX**  
ON SALE  
**NOVEMBER 26th**

**note:**  
*Estimated 13/4 million portable TV sets to be sold in '57!*  
**Here's Your MARKET...**

for the  
**MOSLEY Flush Mount TV Socket**

**LOW LOSS**

**NEAT**

**EFFICIENT**



MODEL F-1PK

• The tremendous demand for portable TV sets opens another BIG market for good set-to-antenna plug-in outlets. MOSLEY Flush Sockets meet this need—supplying attractive, convenient, customer-approved wall outlets for every installation requirement.

Without MOSLEY TV Outlets, portable TV—in most areas—ceases to be portable! Let MOSLEY TV Outlets spark YOUR Portable TV Sales!

For a complete line of up-to-date TV Accessories and Electronic Components send for our "57" catalog.

**Mosley Electronics, Inc.**  
 8622 ST. CHARLES ROCK ROAD  
 ST. LOUIS 14, MISSOURI

**PLEASE MENTION RADIO-ELECTRONICS WHEN ANSWERING ADVERTISEMENTS**

**MORSE CODE**  
 SENDING • RECEIVING • SPEED  
 Complete Instructions.  
 Made Easy with 45 or 78 RPM Record.  
 7 INCH 45 RPM... SEND \$1.25 12 INCH 78 RPM... SEND \$2.25  
 Prices Include Postage and Handling

**UNCLE SAM RECORDINGS • Dept. B-11**  
 59 East Van Buren Street Chicago 5, Illinois  
 Sold by leading hobby shops, radio-electronic dealers, hi-fi record shops, chain and department stores everywhere. Dealers, Jobbers and Mail Order firms inquiries invited.

NOVEMBER, 1957

**BUSINESS AND PEOPLE (Continued)**

himself and his wife in the Waldorf Astoria Hotel. Sid White, manager of Cross Island Electronics, the winner's distributor, received an identical prize. M. Harvey Gernsback, editorial director of RADIO-ELECTRONICS, was one of the judges in the contest.

Sylvania Electric Products broke ground for a new million-dollar addition to its Physics Laboratory in Bay-side, N. Y.

Andre Meyer, senior partner of Lazar Freres & Co.; Paul M. Mazur, partner, Lehman Bros.; and Robert W. Sarnoff, president of NBC, were elected new members of the Board of Directors of RCA, increasing membership from 14 to 17.

Richard D. Kennedy, advertising account supervisor for the General Electric Apparatus Dept., was promoted to the new post of advertising and sales promotion manager for the Receiving Tube Dept., Owensboro, Ky.



James Ewing succeeds William Klein as vice president of sales of Gabriel Co., parent company of Ward Products, Cleveland, Ohio. Klein is now vice president, merchandising. Ewing joined Gabriel from Mechanical Handling Systems, Inc.



John P. Taylor (left) is now manager, marketing plans and services, RCA Industrial Electronic Products, Camden, N. J., Herman R. Henken,



former advertising and sales promotion manager for RCA theatre and industrial products, succeeds him as manager, advertising and sales promotion, for industrial electronic products.

Leonard T. Donnelly joined Allen B. Du Mont Labs., Inc., Clifton, N. J., as manager of component sales. He comes to Du Mont from W. L. Maxson Corp., where he was administrative assistant to the sales manager.



C. Graydon Lloyd is the new general manager of the General Electric Specialty Electronic Components Dept., Auburn, N. Y. He was promoted from manager of engineering of the General Electric Technical Products Dept.



**'SCOPES ARE "GOLD MINES"**

... When you learn to use them **RIGHT** ... on all kinds of service jobs!

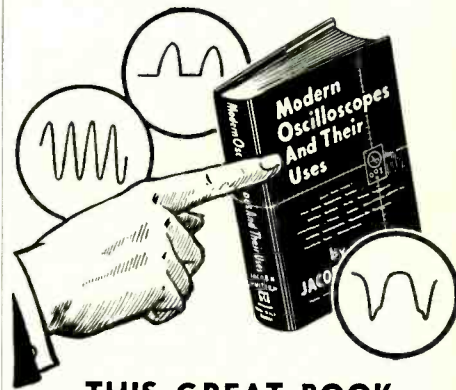

**THIS GREAT BOOK TELLS ALL YOU NEED TO KNOW ABOUT THEM!**

**Big 2nd Edition**

Contains Latest Data and More Than 30 Extra Pictures.

Includes use of scopes in color TV... black and white TV... Radio... Industrial Electronics... Teaching... even in atomic energy work!

Here's the "secret" of servicing any radio or Television set ever built... easier, better and faster!

In plain language, MODERN OSCILLOSCOPES AND THEIR USES brings you the data on 'scopes that you really need. It teaches you when, where and exactly how to use oscilloscopes on all types of jobs.

You can learn how to handle tough jobs easier and faster than you may have thought possible. Every detail is clearly explained—from making connections to adjusting components and setting the controls.

**WORK EASIER—BETTER—FASTER**

Equally important, you learn how to analyze oscilloscope patterns accurately and in less time. Almost 400 illustrations including dozens of pattern photos make every step perfectly clear.

This famous book—now in its revised 2nd Edition—is more widely used than any other of its type. That's because it gets right down to "brass tacks" in a way you can hardly fail to understand. No complicated mathematics. No involved theoretical discussions. You learn exactly how to use your oscilloscope on all types of AM, FM and television service (including color TV). You learn each step of the work fully—from locating troubles fast to handling tough realignment jobs.

**PRACTICE 10 DAYS FREE!**

Dept. RE-117, RINEHART & CO., INC.  
 232 Madison Ave., New York 16, N.Y.  
 Send 2nd Edition of MODERN OSCILLOSCOPES for 10-day FREE EXAMINATION. I will then return \$6.50 (plus postage) promptly in full payment or return book and owe you nothing. (SAVE! Send \$6.50 with order and we pay postage. Same 10-day return privilege with money refunded.)

Name.....  
 Address.....  
 City, Zone, State.....  
 OUTSIDE U.S.A.—Price \$7.00, cash with order. Money back if you return book in 10 days.

# STAN-BURN

## CATHODE RAY TUBE SPECIALS ONE YEAR GUARANTEE

G.E.	Type	STAN-BURN	G.E.	Type	STAN-BURN
\$15.80	10BP4	\$10.00	24.75	17LP4	\$18.00
19.10	12EP4A	13.95	37.00	21AP4	24.00
	12OP4	11.50	28.35	20CP4A	18.95
30.25	12UP4	15.00	33.60	20CP4B	21.95
20.75	14CP4	13.75	36.00	21AP4	25.00
	15DP4	14.50	29.75	21EP4A	20.15
33.75	16AP4	18.50	34.85	21EP4B	23.25
32.20	16BP4A	15.25	30.90	21FP4	21.15
23.50	16KP4	15.75	37.00	21MP4	26.25
28.40	16KP4A	18.75	29.75	21YP4	22.00
33.75	16GP4	18.75	34.85	21YP4A	25.00
31.50	16LP4A	16.25	28.30	21ZP4	21.00
31.50	18WP4	16.25	33.60	21ZP4B	24.00
23.50	17BP4	15.75	100.00	24AP4	56.00
28.40	17BP4B	18.75		24CP4	48.00
30.75	17CP4	20.50	48.40	24CP4A	38.00
33.90	17GP4	21.50	50.00	24DP4A	39.00

\*Aluminized INQUIRE FOR ANY TUBE TYPE NOT LISTED. STAN-BURN CRT TUBES RCA LICENSED-MFD. BY LINCOLN. All orders of 6 or more STAN-BURN CRT are subject to additional 100% discount. PRICES SUBJECT TO CHANGE WITHOUT NOTICE.

## WHY PAY MORE?

HI-FI COMPONENTS • KITS  
RECORD PLAYERS • TAPE RECORDERS • TUNERS  
AMPLIFIERS • SPEAKERS & ELECTRONIC PARTS & TUBES • Etc.

Top brand nationally advertised merchandise in this and other Radio & TV mags. is yours at low, low cost. Send us your list. Give Mfr's name and Model No. of item. Write for '57 catalogs to Dept. RE-11 today.

### BRAND NEW IMPORTED TAPE RECORDERS

Clear, sharp music and speech reproduction. Dual track, 5 tube balanced amp., 6" tape reel, Magic Eye tube, numerical footage counter, 2 tone maroon & grey leatherette case, portable, compact mechanism, weighs under 17 lbs. AMAZING VALUE!

- Single Speed (3%) ..... \$64.95
- Dual Speed (3% & 7 1/2) ..... 74.95

FREE reel of tape with each recorder!

### HI-FI DIAMOND NEEDLES—1 Yr. Guar.

Diamond needles reduce record wear and needle noise thus retaining full frequency response and tonal qualities of your records for a longer period of time.

- SINGLE DIAMOND needle ..... \$7.95
- DIAMOND SAPP dualneedle ..... \$8.95

Shipment PPD. (specify cartridge make)

### RECORD CHANGERS

- Collaro RC-456, 4 speed changer ..... \$33.81
- Garrard RC-88, 4 speed changer ..... \$3.41
- Garrard RC-98, 4 speed changer ..... 66.15

FREE wood mounting base, record wiping cloth and 45 RPM spindle with all orders for Collaro and Garrard changers, with this ad.

- VM 4 SPEED HI-FI CHANGER—Model 1210 with Ronette or Astatic flip-over cartridge ..... \$22.95
- MONARCH Model UABU 4 SPEED AUTO. INTERMIX CHANGER less crystal cartridge ..... \$19.95
- RONETTE (phono fluid) cartridge flip-over type ..... \$2.98
- SONOTONE cartridge, flip-over ..... \$2.98
- 45 RPM SPINDLE for V.M. or Monarch ..... \$1.98
- WOOD MOUNTING BASE for V.M. or Monarch 3.95
- MOUNTING BOARD unfinished for V.M. or Monarch ..... 1.50

General Electric Hi-Fi Variable Reluctance cartridge. Replaces discontinued RPX050 type. Full range reproduction 20—20,000 cycles. Four gram tracking force for minimum record and stylus wear.

- 4G050—Dual Sapphire needles ..... \$8.77
- 4G052—Diamond, Sapphire needles ..... \$18.99

## KITS!

We stock the following manufacturers complete line of kits—see reference pages.

- EICO see pages 20-30
- QUALITY see page 162
- PRECISE ELECTRO-VOICE
- BOGEN see page 8
- GROMMES see page 150
- ARKAY see page 146
- Inside Back Cover
- CABINART

All domestic orders will be shipped prepaid. Send us your list. Order by Mfr. and Model No. of item.

### \$20 WORTH OF ELECTRONIC PARTS IN GRAB-BAG

consisting of: Porcelain sockets, coils, speaker, trans. resis, cond. ONLY ..... \$1.98 (plus 50c postage)

1957 PHONOLOG PHONOGRAPHS  
All models have 4 speed automatic changers in portable carrying cases, shuts off after last record, jam proof, turnover cartridge, sapp needles, attractive modern styling with tone and volume controls:  
#757 ECONOMY MODEL—mist blue and white simulated leatherette, crystal cart ..... \$37.50  
#857 DUO-FI—2 speakers, 2 tone grey leatherette, 45 RPM spindle, ceramic cart ..... 49.00  
#957 HI-FI—2 special HI-FI speakers, ebony starlite leatherette, 45 RPM spindle, ceramic cart ..... 56.50  
#1057 HI-FI—3 special HI-FI speakers, 3 controls (base, treble & Vol.), ceramic cart, Diamond/Sapp needles, 45 RPM spindle, Luggage Tan leatherette ..... 78.00

### NATIONALLY ADVERTISED IN LIFE, POST, ESQUIRE

### YOU NAME IT—WE HAVE IT

Complete line of T.V. & Radio receiving tubes, coils, trans., controls, antennas & accessories—No Minimum Order—DEALER DISCOUNTS! Thousands of satisfied HI-FI enthusiasts and dealers will vouch that STAN-BURN GIVES THE BEST DEAL POSSIBLE!  
Export inquiries and offers invited.  
Terms: 20% with order. Balance C.O.D. All prices F.O.B. NEW YORK Warehouse.  
Write for our latest list and HI-FI Catalog RE-11. All Prices Subject to Change Without Notice

**STAN-BURN** RADIO and ELECTRONICS CO.  
558 CONEY ISLAND AVE. • B'KLYN 18, N. Y.

## BUSINESS AND PEOPLE (Continued)

Rein Narma was appointed manager of the Production and Engineering Divisions of Fairchild Recording Equipment Co., Long Island City, N. Y. He will also continue to serve as chief engineer.

David G. Cowden (top left), was named manager of special-purpose tube operations for the Sylvania Television Picture Tube Division, Seneca Falls, N. Y. He had been chief of mask operations in the Color TV Tube Dept. J. E. Schlener (top right), merchandising



manager for the semiconductor division, is the new Eastern District sales manager of the division with headquarters in Woburn, Mass. Bernard R. McCarthy (bottom left) and Marvin E. Groll (bottom right) were appointed sales engineers for the Semiconductor Division with headquarters in Philadelphia and Woburn, Mass., respectively. McCarthy comes to the company from the New York Transit Authority and Groll was formerly an electronic tube sales engineer for Sylvania.

Jack K. Poff, Jobber Division sales manager for Pyramid Electric Co., was elected a director of National Electronic Plastics Inc., Matawan, N. J.

Donald Wells and Lynn Lockwood joined Finney Co., Bedford, Ohio, from Welco Antenna Co. Wells will direct the Finco Models Unlimited Research Program and Lockwood will be a special factory representative. Richard Linnert, a well known television sales engineer, joined the company as special sales engineer.

Matthew James Leonard (left) is vice president, customer relations, Hycon Manufacturing Co., Pasadena, Calif. He joined the company from Hughes



Aircraft Co. O. H. Mackley was appointed vice president and general manager of Hycon Electronics, a subsidiary. He was technical services manager of the former Military Electronic Division and served as manager of the subsidiary since last March.

Robert J. Reigel was elected vice president in charge of sales for Adorn Plastics Specialists Inc., Chicago. END

# t-m KITS

- Advanced designs for the best in high fidelity reproduction
- Build and save do-it-yourself
- See them at your local radio parts distributor



**New 60 WATT HIGH FIDELITY AMPLIFIER-PREAMP KIT**

An integrated high power amplifier package for the audio perfectionist—complete with versatile pre-amplifier in one compact high styled unit—at a budget price. Undistorted power output is guaranteed to be 60 watts from 20 to 20,000 cps. Intermodulation is 1% at 60 watts and below 0.25% at ordinary listening levels.

- Model 19K ..... \$79.95
- Cabinet ..... 7.50



**New 25 WATT HIGH FIDELITY AMPLIFIER-PREAMP KIT**

Top quality integrated amplifier preamplifier system on a single chassis at exceptionally low price. Performance equals or exceeds any available amplifier up to rated power of 25 watts.

- Model 21K ..... \$59.95
- Cabinet ..... 7.50

### WILLIAMSON TYPE 20-WATT AMPLIFIER



Frequency response flat and smooth thru entire audible range • Less than .0025 distortion at normal listening levels • Excellent transient characteristics.  
Model TM-15A, complete with tubes—sockets, terminal strips, and connectors mounted ..... \$49.95

### PREAMPLIFIER with Cathode Follower Output



4 input channels • Separate bass and treble controls • 3-position equalizer • AC outlet for auxiliary equipment • Powered by main amplifier.  
Model TM-17P, complete ..... \$19.95

### HI-FI FM TUNER



Self-contained power supply • Tuning range 87-109 Mc • 200Kc IF bandwidth • Grounded-grid RF stage • AFC with front-control cutoff • Micro-vernier tuning • No-drift ratio detector • 4 uv sensitivity for 20 db quieting • Standard de-emphasis network • .8 volt RMS cathode-follower output • 3.2 volt RMS high-impedance output • 300 ohm input impedance • Switch-controlled AC receptacle for auxiliary equipment.  
Model FM-18, complete with punched chassis, tubes, and hardware (less wire and solder) ..... \$29.50

# t-m KITS

Write for latest catalog to:  
a product of  
**TECH-MASTER CORPORATION**  
75 Front St., B'klyn 1, New York



# Patents

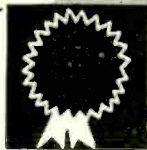

## CORDLESS CLOCK

Patent No. 2,786,972

Theodore Dreier, Niskayuna, N. Y., and Ira A. Terry, Ashland, Mass. (Assigned to General Electric Co., Inc., New York.)

This battery-powered clock uses a transistor circuit to produce enough alternating power to operate its motor. The frequency of the power is controlled by and synchronized with a small alternating voltage obtained from the stray

V3's collector is applied across one of the motor coils through a circuit including the battery, resistor R1 and transistor V3. The other motor coil is closely coupled to the first and provides feedback to V3's base through R2 and C2.

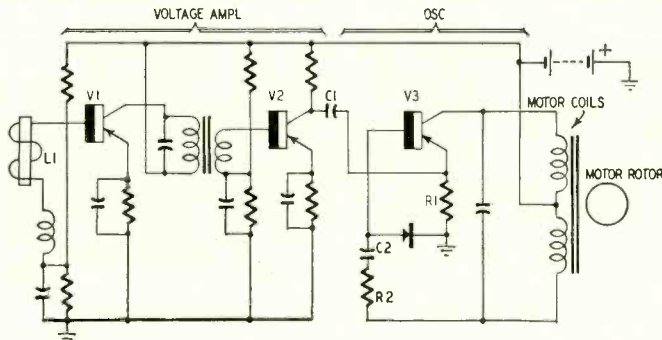

fields that exist near low-frequency commercial power lines.

Pickup coil L1 provides a means of obtaining energy from stray fields produced by power lines in the walls. The first two stages amplify the induced 60-cycle signal. The third stage operates as a 60-cycle oscillator. Output from

The frequency of oscillation is stabilized at 60 cycles by the coupling capacitor C1 between the collector of V2 and the emitter of V3. Circuit components are selected so the natural frequency of the oscillator is substantially 60 cycles. Even upon failure of commercial power the clock continues to operate at approximately the proper rate.

## SUPERREGENERATIVE RECEIVER

Patent No. 2,792,494

Jerome J. Suran and Woo Fong Chow, Syracuse, N.Y. (Assigned to General Electric Co.)

This is a good example of the simple, highly sensitive circuits that may be designed with modern transistors. It is a superregenerative receiver requiring only a 3-volt battery. One transistor (V2) operates as detector, the other as a separate quench oscillator (V1). V1 is a Unijunction *n-p* transistor. See "Using the Unijunction," July, 1957, page 91, which described a *p-n* Unijunction. It will suffice to say here that both transistors are inherently regenerative and show a negative resistance when connected as in the diagram.

The ultrasonic frequency from the oscillator is developed across R1, which impresses it upon the regenerative detector. The carrier tank is L-C1, tapped for Hartley operation. R2 controls the tank's Q which, if too high, results in critical tuning.

T is a matching transformer for headphones or amplifier and loudspeaker. C2 bypasses the quench frequency.

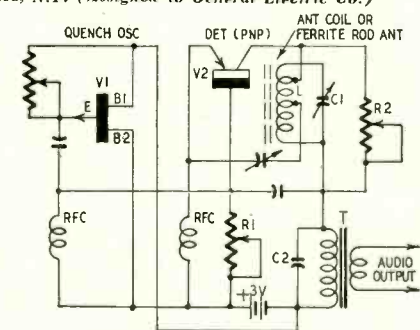

With careful design, a gain of 53 db may be obtained from this simple circuit on the broadcast band.

## MODULATION CONTROL

Patent No. 2,759,052

Angus A. Macdonald, Hinsdale, and Robert C. Baltesore, Ballwood, Ill., and William J. Parks, Fort Wayne, Ind. (assigned to Motorola, Inc., Chicago, Ill.)

In a phase-modulation transmitter, the carrier frequency deviates in proportion to both amplitude and frequency of the modulating signal. This means that a low-amplitude high-frequency

signal can overmodulate just as a low-frequency high-amplitude can. This transistor circuit provides suitable clipping to prevent overmodulation.

The modulation signal is differentiated by R1-C1. This produces a voltage output that varies with the rate of change of signal. For example, a higher modulating frequency generates a higher voltage than one of lower frequency, when both have the same amplitude. (The grounded-emitter CK721 is designed for symmetrical clipping at 0.7 volt.) Transistor output is integrated by R2-C2 which compensates for the previous differentiation. The signal is now impressed on the modulator.

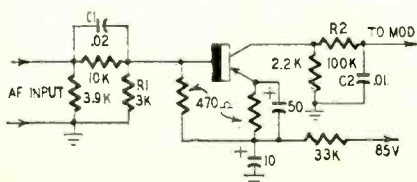

# ONE DOLLAR buys

As much as \$15 worth — Everything Brand New and sold to you with a money back guarantee.

**DEDUCT 10% ON ANY ORDER OF \$10 OR OVER**

Plus a FREE SURPRISE PACKAGE

- 100 - ASSORTED 1/2 WATT RESISTORS.....\$1
- 70 - ASSORTED 1 WATT RESISTORS.....\$1
- 35 - ASSORTED 2 WATT RESISTORS.....\$1
- 100 - FUSES 1 AMP standard size 1 1/4" x 1/4".....\$1
- 5 - RCA 6' LINE CORDS 550Ω with plugs.....\$1
- 10 - 6 FT. ELECTRIC LINE CORDS with plugs.....\$1
- 5 - TV CHEATER CORDS with both plugs.....\$1
- 4 - 50' SPOOLS HOOK-UP WIRE 4 colors.....\$1
- 100' - TWIN LEAD-IN WIRE 300Ω heavy duty.....\$1
- 50' - FLAT 4-CONDUCT WIRE, many purposes.....\$1
- 1 - \$7 INDOOR TV ANTENNA hi-gain 3 section.....\$1
- 20 - ASST. TV KNOBS, ESCUTCHEONS, Etc.....\$1
- 15 - ASSORTED ROTARY SWITCHES \$15 worth.....\$1
- 100' - FINEST NYLON DIAL CORD best size.....\$1
- 200 - SELF TAPPING SCREWS #8 x 1/2".....\$1
- 50 - ASST. TUBULAR CONDENSERS.....\$1
- 5 - ELECTROLYTIC COND. 100/50 - 50/25v.....\$1
- 35 - ASST. RADIO KNOBS screw and push-on.....\$1
- 100 - KNOB SPRINGS standard size 3/8" x 1/2".....\$1
- 100 - ASSORTED KNOB SET-SCREWS.....\$1
- 25 - ASSORTED CLOCK RADIO KNOBS.....\$1
- 400 - ASST. H'DWARE, screws, nuts, rivets, etc.....\$1
- 50 - ASST. SOCKETS octal and miniature.....\$1
- 50 - ASST. MICA CONDENSERS some in 5%.....\$1
- 50 - ASST. CERAMIC CONDENSERS.....\$1
- 10 - ASST. VOLUME CONTROLS less switch.....\$1
- 5 - ASST. VOLUME CONTROLS with switch.....\$1
- 20 - ASST. PILOT LIGHTS #44, 46, 47, 51.....\$1
- 10 - PILOT LIGHT SKTS. bayonet type, wired.....\$1
- 50 - ASST. TERMINAL STRIPS 1, 2, 3, 4 lug.....\$1
- 10 - ASST. RADIO ELECTRO. CONDENSERS.....\$1
- 5 - ASST. TV ELECTROLYTIC CONDENSERS.....\$1
- 15 - ASST. TV COILS sync. peaking, width, etc.....\$1
- 25 - ASST. MICA TRIMMER CONDENSERS.....\$1
- 50 - TUBULAR CONDENSERS .02-100v.....\$1
- 50 - TUBULAR CONDENSERS .001-800v.....\$1
- 20 - TUBULAR CONDENSERS .047-600v.....\$1
- 50 - TUBULAR CONDENSERS .01-400v.....\$1
- 3 - ELECTROLYTIC COND. 50/30 - 150v.....\$1
- 3 - ELECTROLYTIC COND. 40/10/10 - 450v.....\$1
- 3 - ELECTROLYTIC COND. 50/25/10-150v.....\$1
- 10 - HV TUBULAR CONDENSERS .006-1800v.....\$1
- 10 - HV TUBULAR CONDENSERS .03-2000v.....\$1
- 10 - HV TUBULAR CONDENSERS .005-3000v.....\$1
- 10 - HV TUBULAR CONDENSERS .001-6000v.....\$1
- 10 - HV TUBULAR CONDENSERS .005-6000v.....\$1
- 35 - MICA COND. 20 - 100 mmf & 15 - 2500 mmf.....\$1
- 35 - MICA COND. 20 - 470 mmf & 15 - 1000 mmf.....\$1
- 35 - MICA COND. 20 - 680 mmf & 15 - 10K mmf.....\$1
- 35 - CERAMIC COND. 20-25 mmf. & 15-47 mmf.....\$1
- 35 - CERAMIC COND. 20-88 mmf & 15-1500 mmf.....\$1
- 35 - CERAMIC COND. 20-250 mmf and 15-080 mmf.....\$1
- 50 - 100Ω 1/2 WATT RESISTORS 5%.....\$1
- 75 - 680Ω 1/2 WATT RESISTORS 10%.....\$1
- 75 - 470KΩ 1/2 WATT RESISTORS 10%.....\$1
- 50 - 3.3Ω 1 WATT RESISTORS 10%.....\$1
- 50 - 15KΩ 1 WATT RESISTORS 10%.....\$1
- 50 - 470KΩ 1 WATT RESISTORS 10%.....\$1
- 25 - 2.2Ω 2 WATT RESISTORS 5%.....\$1
- 25 - 3.3Ω 2 WATT RESISTORS 5%.....\$1
- 25 - 100KΩ 2 WATT RESISTORS 10%.....\$1
- 10 - ASST. WIREWOUND RES. 5, 10, 20 watts.....\$1
- 3 - AUDIO OUTPUT TRANSFORMERS 50L6 type.....\$1
- 3 - AUDIO OUTPUT TRANS. 6K6 or 6V8 type.....\$1
- 3 - I.F. COIL TRANSFORMERS 456kc.....\$1
- 3 - I.F. COIL TRANSFORMERS 10.7 mc FM.....\$1
- 4 - OVAL LOOP ANTENNAS asst. hi-gain types.....\$1
- 3 - LOOPSTICK ANT. new ferrite, adjustable.....\$1
- 12 - RADIO OSCILLATOR COILS 456kc.....\$1
- 3 - 1/2 MEG VOLUME CONTROLS with switch.....\$1
- 1 - 5" PM SPEAKER alnico #5 magnet.....\$1
- 5 - SETS SPEAKER PLUGS, wired.....\$1
- 10 - SETS PHONO PLUGS and PIN JACKS.....\$1
- 2 - \$2.50 SAPPHIRE NEEDLES 4000 playings.....\$1
- 5 - DIODE CRYSTALS 2-IN21 2-IN23 1-IN64.....\$1
- 1 - TV VERT. OUTPUT TRANS. 10 to 1 ratio.....\$1
- 5 - TV CRT. SOCKETS with 18" leads.....\$1
- 5 - HI-VOLT. ANODE LEADS with 18" leads.....\$1
- 1 - TV SYNCHROUIDE TRANSFORMER #205R1S1
- 1 - TV SYNCHROLOC TRANSFORMER #208T8
- 1 - TV RATIO DETECTOR TRANS. 4.5mc.....\$1
- 1 - SET TV KNOBS standard type incl. decals.....\$1
- 1 - LB SPOOL ROSIN CORE SOLDER 40/60.....\$1
- 6 - SPIN TIGHT SOCKET SET 3/16" to 7/16".....\$1
- 3 - TV ALIGNMENT TOOLS 5", 7", 12".....\$1

HANDY WAY TO ORDER—Simply tear out advertisement and pencil mark items wanted, enclose with money order or check. You will receive a new copy of this ad for re-orders.

ON SMALL ORDERS—Include stamps for postage, excess will be refunded. Larger orders shipped express collect.

## BROOKS RADIO & TV CORP.

84 Vesey St., Dept. A, New York 7, N. Y.

Please send items checked

Name  please print

Street

City  State

TOWARD THE ULTIMATE IN TV RECEPTION

**DeRO**

**PROVEN**

*by Performance!*

**POPULAR WITH SERVICEMEN**

**PERSONNA-TONE Model PS-20**

Remote Control EXTENSION SPEAKER

High-quality sound for chair-side TV listening. 4x6 speaker. Selector switch and volume controls for TV set. Persona-Tone, or both speakers. Wood veneer cabinet. Complete with cable.

List 9<sup>95</sup>



**DUAL-TONE Model DT-32**

Dual Speaker VOLUME CONTROL

For auto radio sound extension. Two volume controls—one for each speaker. Volume of either speaker adjusts to any level independently. Ample cable for all cars.

List 3<sup>95</sup>



**All-Purpose DeRO-JUVENATOR**

One rejuvenator replaces all! Model RU-5—universal E-wire for use on all series or parallel filament TV sets, both electrostatic and electromagnet. Restores brilliance and contrast to pix tube.

List 3<sup>95</sup>



Model RU-5

FREE Write for latest catalog



**DeRO ELECTRONICS**

134 MASSAU RD. ROOSEVELT, L. I., N. Y.

**JOBBERS—WRITE FOR DETAILS**

Look for this display!



This colorful, small space counter merchandiser identifies DeRO's quality and engineering—your guarantee of satisfaction. Look for it!

**RADIO AND TV SERVICEMEN**

make more money with this

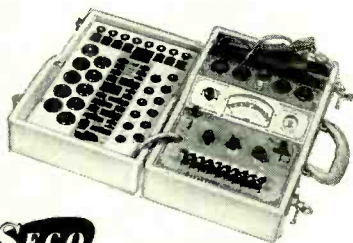

**Model 107 TUBE TESTER**

3 complete tests in one handy instrument

Here's the tube tester every serviceman has been asking for! Designed for outstanding performance and accuracy—provides 3 important tests: Dynamic Mutual Conductance Test of all popular radio and TV amplifier tubes—Cathode Emission Test for all tubes by free point selector system—nationally accepted Grid Circuit Test developed and patented by Seco. Saves you valuable time—quickly pays for itself by justifiably culling and selling more tubes for you!

Completely self-contained in compact portable carrying case. Furnished with handy flip-chart for fast, easy tube set-up data.

**\$139.50** net



Write today for free literature  
**MANUFACTURING CO.**  
5015 Penn Ave. So., Mpls., Minn.

**Can you think faster than this Machine?**

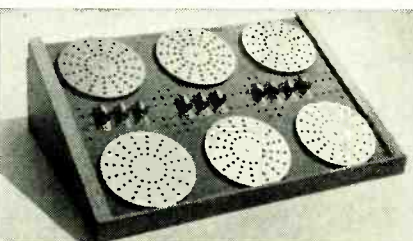

Control Panel of GENIAC set up to do a problem in check valve research.

Be careful before you answer. GENIAC the first electrical brain constructed in kit is equipped to play tic-tac-toe, cipher and encipher codes, convert from binary to decimal, reason (in syllogisms) as well as add, subtract, multiply and divide. Specific problems in a variety of fields—actuarial, policy claim settlement, physics, etc.—can be set up and solved with the components. Connections are solderless and are completely explained with templates in the manual. This covers 33 circuits and shows how new ones can be designed. You will find building and using GENIAC a wonderful experience; one kit user wrote us: "This kit has opened up a new world of thinking for me." You actually see how computing, problem solving, and game play (tic-tac-toe, num, etc.) can be analyzed with Boolean Algebra and the algebraic solutions transformed directly into circuit diagrams. You create from over 400 specially designed and manufactured components a machine that solves problems faster than you can express them.

Schools and colleges, teachers of science or math, engineering, philosophy or psychology will find these excellent demonstrators of circuitry, solutions in symbolic logic, theory of numbers, cybernetics, and automation.

Note: Teachers take advantage of our 10% discount to educational institutions and for group purchases.

SEND for your GENIAC kit now. Only \$19.95 with over four hundred components and parts, fully illustrated manual and wiring diagrams. We guarantee that if you do not want to keep GENIAC after one week you can return it for full refund plus shipping costs.

—MAIL THIS COUPON—

**SCIENCE KITS**  
Dept. RE117A, Oliver Garfield Co.  
126 Lexington Ave., N.Y. 16, N.Y.

Please send me:

1 GENIAC Electric Brain Construction Kit and Manual.

\$19.95 (East of Mississippi)

\$20.95 (Elsewhere in United States)

\$21.95 (Outside the United States)

Returnable in seven days for full refund if not satisfied. I enclose \$\_\_\_\_\_ in full payment.

My name and address are attached.

PATENTS (Continued)

The differentiator takes care of the frequency effect on phase modulation. Since output voltage depends upon frequency, the higher-frequency components will have reduced effect on the modulator (after clipping). No voltage higher than 0.7 appears at the modulator. If the latter is correctly designed, the carrier cannot be overmodulated regardless of modulating frequency or amplitude.

**SOLAR BATTERY CHARGER**

Patent No. 2,780,765

Daryl M. Chapin, Basking Ridge, Calvin S. Fuller, Chatham, and Gerald L. Pearson, Bernards Township, Somerset County, N.J. (assigned to Bell Telephone Labs., Inc. New York, N.Y.)

Solar cells have been used to power transistor radios and perform other light duty. An even more useful application is to charge a battery, so that power may be made available during the night or on dark days. The cells described here are highly efficient so that maximum power is delivered to the charging battery.

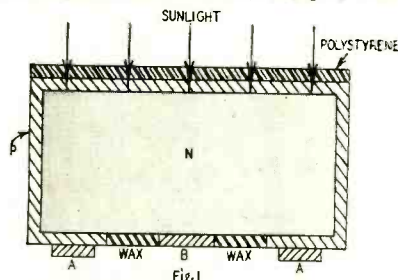

Fig. 1

Each cell is a p-n junction, formed of n-type silicon with boron diffused to make a p-type border around it (Fig. 1). The p material is only 0.1 mil thick to permit light to fall onto the junction itself. Two metal terminals (A) are electroplated to each end of the p material to lower lead resistance. A single lead (B) is connected to the n material. Wax seals off the cell and reduces leakage between A and B. A polystyrene layer reduces reflection on the side facing the light source.

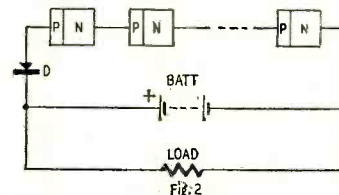

Fig. 2

Each cell made in accordance with the preceding supplies an open circuit voltage of 0.52 volt, and each is capable of delivering 65 watts per square meter of surface. To charge a battery, a group of cells is connected in series (Fig. 2). Diode D permits easy flow in the charge direction and prevents battery discharge into the cells. END



"You won't believe the realistic, life-like sound."

**NEW  
EXCITING**

# SUBMINIATURES

by  
**Suporex!**

**New! Suporex Whisper  
PILLOW PHONE**

List \$5<sup>95</sup>

complete with  
6' cord, wired  
plug and jack

Now you can enjoy personal listening through the pillow with the comfort and relaxation of a loudspeaker! Exceptional tonal quality! Comes with simplified instructions for connecting to radio or TV set . . . plugs into transistor radio directly. In sanitary Ivory-white.

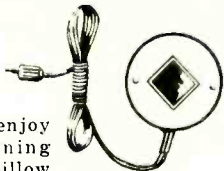

**New! Suporex  
DYNAMIC  
EARPHONES**

List \$4<sup>50</sup> ea.

Provides loud volume where others whisper! Finest quality construction . . . modern 2,000-ohm D.C., 8,000-ohm A.C. High sensitivity for low output circuit. Latest ferrite magnet; twisted pair wires minimize interference. Cushioned ear support, comfortable ear coupling. Also available 4-8-ohms for 80% of Transistor Radios.

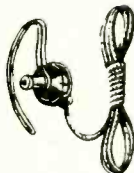

**New! Suporex  
IMP-PHONES**

List \$2<sup>25</sup> ea.

Subminiature lightweight crystal earphone with high sensitivity. Excellent high fidelity! High impedance (100,000-ohms); removable clear plastic tip; twisted pair wires for minimum interference. Circuits included show use as crystal microphone. Complete with instructions, circuits, phone tips, carrying case.

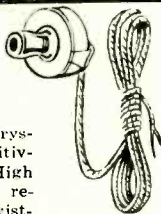

**New! Suporex  
PLUGS and JACKS**

List 39¢ ea.

Smallest phone plugs and jacks available . . . ideal for transistor and miniature applications. Plug overall length 1", dia. 1/4" . . . mounts in panels to 1/16" thick.



**New! Suporex  
VARIABLE CONDENSER**

List \$1<sup>39</sup>

Ideal for transistor radios and wherever space is at a premium! Newest-type solid dielectric. 365 mmf . . . less than 1/4" thick. 1/4" shaft, 180 degree rotation, 1-hole mounting with hardware.



ORDER TODAY FROM YOUR JOBBER!

**Suporex** ELECTRONICS CORP. successor to Grayburne  
6 Radford Pl., Yonkers, N.Y.

# technical Literature



**ELECTRONIC COMPONENTS GUIDE.**

Comprehensive data on IRC's complete line of resistors and other electronic components are presented. — International Resistance Co., 401 N. Broad St., Philadelphia 8, Pa.

**COAXIAL CABLES AND CONNECTORS.**

*microminiature.* Complete data, including actual-size photographs of this manufacturer's line, are presented in a handy 1957 34-page catalog.—Micro-dot, Inc., 220 Pasadena Ave., S. Pasadena, Calif.

**THIS IS HIGH FIDELITY, revised edition.**

In its 16 colorful pages, high-fidelity reproduction of voice and music is carefully explained—Allied Radio Corp., 100 N. Western Ave., Chicago 80, Ill. 10c.

**PANEL-MOUNTING INSTRUMENTS, catalog 57-110,**

lists manufacturer's line of ac vtvm's, dc vtvm's, special models and power supplies. It is illustrated throughout.—Trio Laboratories, Inc., 4025 Merrick Rd., Seaford, N. Y.

**ADJUST-A-CONE SPEAKERS**

are found in this manufacturer's pamphlet. Replacement, outdoor, PA, intercom, rear-seat auto and high-fidelity types are listed.—Quam-Nichols Co., Marquette Rd. and Prairie Ave., Chicago 37, Ill.

**ROD AND SHEET PLASTICS**

for Electronics are the subject of a 17-page brochure, containing technical data sheet for each product.—Emerson & Cuming, Inc., 869 Washington St., Canton, Mass.

**PLASTIC TUBULAR CAPACITOR.**

*Engineering Bulletin BTS* describes a plastic, tubular capacitor with single-ended design for printed circuits.—Pyramid Electric Co., 1445 Hudson Blvd., N. Bergen, N.J.

**TANTALUM-FOIL CAPACITOR, bulletin 152**

discusses the characteristics of such capacitors covering the applications and limitations of polar and nonpolar types of tantalum-foil electrolytics.—Ohmite Mfg. Co., 3655 Howard St., Skokie, Ill.

**RESISTORS, bulletin P-4**

contains detailed data on construction design, applications, dimensions, ranges, ratings, tolerance of type PW-20, 20-watt resistors. *Bulletin G-1b* lists similar information for type MV, high-voltage resistors. *Bulletin P-2c* covers RW-5, PW-7 and PW-10 resistors. *Bulletin A-3a* details type 2W rheostat potentiometers.—International Resistance Co., 401 N. Broad St., Philadelphia 8, Pa.

**HUM AND SHIELDING Data Sheet No. 129**

with 14 photos with captions descriptively illustrates the wrapping of

**TRANSFORMER  
NEWS** FROM TRIAD

## YOKE SERVICING SIMPLIFIED

CHANGE THIS

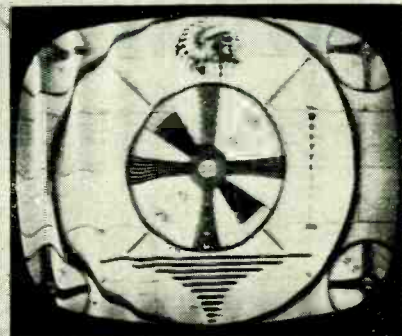

This is caused by improper value of horizontal damping network—or network mounted on wrong terminal.

TO THIS

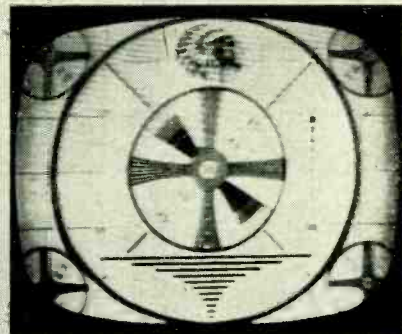

WITH THIS

FLYBACK	YOKE	NETWORK	VERT. OUT
738079 D-44	708176 Y-19(-3)	NW-1	738081 A-111X
738068 <sup>(1)</sup> D-43	708177 Y-22(-3)	NW-1	738066 -118X
738078 <sup>(2)</sup> D-95 <sup>(2)</sup>	708174 Y-41(-3)	<input checked="" type="checkbox"/> <input type="checkbox"/> <input type="checkbox"/> NW-4	738076 -118
738099 <sup>(2)</sup> D-81	Y-19(-3)	NW-1	

Correct yoke servicing\* information as listed in Triad's Television Replacement Guide TV-57. It is available at your distributor.



\*Bonus information to the PTM offered only by Triad.

4055 REDWOOD AVENUE, VENICE, CALIF.  
812 E. STATE STREET, HUNTINGTON, IND.  
A SUBSIDIARY OF LITTON INDUSTRIES

**Examine FREE**



**Prentice-Hall  
ELECTRONICS &  
UHF LIBRARY**

Edited by  
**W. L. EVERITT**

**5 VOLUMES 1662 ILLUSTRATIONS**

*Pay Easy Installments If You Keep the Set*

Turn to this new, up-to-date Library with complete confidence, for dependable facts on any phase of modern electronic theory and practice. These volumes, by outstanding authorities, give you thorough guidance—clearly written, logically arranged, profusely illustrated.

**Electronic Fundamentals and Applications**

By Prof. John D. Ryder,  
Dean, College of Engineering, Michigan State University  
Complete, logical, easy-to-follow treatment of (a) physical principles underlying electron tubes, (b) characteristics of vacuum tubes, (c) all basic tube circuits. Includes: Electron Ballistics, Cathode-Ray Tubes, Emission of Electrons, Space Charge in Vacuum Tubes, Diode Rectifiers, Triodes, Multi-Element Tubes, Small-Signal Amplifier Circuits, Audio-Frequency Amplifiers, Radio-Frequency Amplifiers, Oscillator Circuits, Modulation Systems, Wave-Shaping Circuits, Gaseous Conduction, Gas Diodes, Gas Control Tubes and Circuits, Photoelectric Cells, Solid-State Electronics.

**Electromagnetic Waves and Radiating Systems**

By Prof. Edward C. Jordan,  
Head, Dept. Electrical Engineering, Univ. of Illinois  
Covers entire field of electromagnetic engineering. Includes propagation as well as radiation and transmission. Full treatment of UHF transmission lines, wave guides, antennas, slot antennas, radiation and diffraction, ground-wave and sky-wave propagation.

**Ultra High Frequency Engineering**

By Thomas L. Martin  
Head, Dept. of Electrical Engineering, Univ. of Arizona  
Theory and technique of ALL the new fields of electronic engineering: Radar, Telemetering, Electronic computing, Facsimile, Television, Blind landing systems, Pulse-time modulation, Ionosphere measurements, and the others.

**Networks, Lines and Devices**

By Prof. John D. Ryder,  
Dean, College of Engineering, Michigan State University  
Network transformations and theorems, Resonance, Impedance transformation and coupled circuits, Filters, General transmission line, High-frequency line, Equations of the electromagnetic field, Radiation, Transmission and reflection of plane waves at boundaries, Guided waves between parallel planes, Wave guides.

**Elements of Television Systems**

By George E. Anner, University of Illinois  
Complete basic theory, plus current practice, covering: Closed TV systems, Commercial Telesharing Systems, Color TV Systems. Gives clear exposition of all phases of picture transmission, including the new technique of dot interlace.

**SEND NO MONEY—EXAMINE FREE**

Just mail coupon below to get complete 5-Volume Set on 10 DAYS' FREE TRIAL. If not completely satisfactory, return in ten days and owe nothing. Or keep the set and pay only \$7.50 down and \$8 a month for five months until full price of \$47.50 is paid. Decide for yourself—without risk or obligation—just mail coupon to examine Library ten days free.

Prentice-Hall, Inc., Dept. 5744-P1  
Englewood Cliffs, N.J.

Send me the Prentice-Hall ELECTRONICS & UHF LIBRARY (5 Volumes) for ten days' free examination. If fully satisfied in ten days I will send you \$7.50 plus few cents postage and then \$8 a month for five months until full price of \$47.50 is paid. Or I will return the Library in ten days and owe nothing.

Name.....

Address.....

City and State.....

TECHNICAL LITERATURE (Continued)

audio transformers, chokes and other square or rectangular components to prevent magnetic hum. — Perfection Mica Co., Magnetic Shield Div., 1322 N. Elston Ave., Chicago 22, Ill.

**LINEAR TRANSDUCERS, Handbook No. R-50.** Explains the theory and application of Atcotran differential transformers. Basic theory, special design considerations and typical circuits are among the aspects covered.—Automatic Temperature Control Co., Inc., 5200 Pulaski Ave., Philadelphia 44, Pa.

**MORSE-TO-TELEPRINTER Code Converter Trak Model CMP-16,** a 14-page folder, describes in abbreviated form the characteristics of each section of this equipment. Page printer, high-speed punch, recorder, matrix, bias control and receiver sections are covered.—CGS Laboratories, 391 Ludlow St., Stamford, Conn.

**MULTIPURPOSE CRIMPING TOOLS,** their use and performance, are described in an illustrated leaflet.—Electrix Terminals & Connectors, Inc., 990 E. 67 St., Cleveland 3, Ohio.

**CATALOG SHEET G-110** contains data on five pulse transformers, a 60-cycle stroboscope, a resistor kit, Labmarkers for generating time markers and Labcases, plug-in type housings for 3- and 4-terminal networks. — Berkshire Laboratories, 568 Bank Village, Greenville, N.H.

**INSTRUMENTATION,** digital and analog. *Catalog C-704* lists this manufacturer's line of such instrumentation. Direct-reading counters, frequency meters, nuclear scalars and count-rate meters are presented.—Beckman/Berkeley Division, 2200 Wright Ave., Richmond, Calif.

**TRANSFORMERS AND COILS** are illustrated and described in the 24 pages of *Catalog 630*. Among the items listed are antenna coils, audio transformers, chokes, variable capacitors, filters, photo-flash transformers, ratio detectors, transistor components and yokes.—Thordarson-Meissner Mfg. Co., 7th and Belmont Ave., Mt. Carmel, Ill.

**CONVERTER CATALOG 557** presents an entire line of dc to ac converters. Complete specifications along with illustrations are given for each converter. A list of the manufacturer's representatives, performance charts, converter selector chart for tape recorder applications and installation instructions are also included.—Carter Motor Co., 2711A W. George St., Chicago 18, Ill.

**LIST OF FM STATIONS** in the United States and Canada is presented in a 10-page booklet. Information with each station includes city, call letters, channel number, frequency, power, antenna height, latitude, longitude and network affiliation.—Audiocraft Magazine, Publishing House, Great Barrington, Mass. 50c.

**STEREOPHONIC SOUND** is described in a colorful 16-page booklet. An illus-



**DO YOU  
HAVE the  
EARS,**

**for EASY LISTENING?**

**NOW YOU CAN HAVE EASY LISTENING at a LOW COST**

Easy listening—velvet smooth response over the entire audio range—that's what you get in a new Utah Unidrive Coaxial High Fidelity Reproducer.

Engineered for exceptionally fine frequency extension of both the bass and extremely high registers—a Unidrive will give you unsurpassed tonal quality—with minimum distortion—a velvet smoothness that is a revelation and a real pleasure to hear.

The Utah Unidrives are unique in design and assembly technique. A single, high efficiency magnet drives two perfectly matched and balanced high and low frequency cones with mechanical crossover, to achieve an efficiency heretofore unattainable in conventional designs. A newly developed skiver roll cone treatment immeasurably increases speaker lifetime.

See and hear the new Utah Unidrives at your dealers today. Available in six models and five sizes—6 X 9", two 8", two 12" and 15". Starting at the unbelievably low price of only \$15.95.

**utah RADIO PRODUCTS CORPORATION**  
HUNTINGTON, INDIANA

Expt. Dept. Fidevox International, Chi., Ill.

**READ  
RADIO-ELECTRONICS  
EVERY MONTH**

**LMB "SAL-MET"**  
LMB Presents The New

FREE 1957 CATALOG covering the full precision engineered line of original box chassis as manufactured by LMB including new Miniature, new Jiffy, new T.F., new Utility Boxes. Eleven different types, 160 different shapes and sizes. A ready reference for engineers, experimenters or anyone using metal boxes. Send for your FREE CATALOG now! "SAL-MET" Non-corrosive Flux—solders copper to aluminum, aluminum to aluminum, any metal to any metal using conventional solder and regular soldering methods. Send for both LMB and "SAL-MET" Catalogs.

LMB, 1011 Venice Blvd., Los Angeles 15, Calif.

TECHNICAL LITERATURE (Continued)

trated article explains what is meant by stereophonic sound and how it is realistically reproduced by stereophonic home music systems. A catalog section lists complete specifications and operating characteristics of this manufacturer's line.—Ampex Audio, Inc., 1020 Kifer Road, Sunnyvale, Calif.

**POWER POINTS DIGEST, Vol. 12, No. 4**, a 2-color 16-page booklet, describes Vacu-Flo cooled electric plant applications.—D. W. Onan & Sons, University Ave. at 25th St., Minneapolis 14, Minn.

**THERMOSETTING ELECTRICAL TAPES.** A 4-page 2-color booklet outlines the properties, recommended application procedures and advantages of Scotch brand electrical tapes with thermosetting adhesive.—Minnesota Mining & Mfg. Co., Dept. D7-207, 900 Bush St., St. Paul, Minn.

**RECORDING TAPE.** An illustrated brochure, *How to Choose the Right Recording Tape*, offers general information on magnetic recording tape, and covers also recording characteristics and the elements, Mylar and cellulose acetate, which govern tape's physical characteristics. — Reeves Soundcraft Corp., 10 E. 52 St., New York, N.Y.

Any or all of these catalogs, bulletins, or periodicals are available to you on request direct to the manufacturers, whose addresses are listed at the end of each item. Use your letterhead—do not use postcards. To facilitate identification, mention the issue and page of RADIO-ELECTRONICS on which the item appears. UNLESS OTHERWISE STATED, ALL ITEMS ARE GRATIS. ALL LITERATURE OFFERS ARE VOID AFTER SIX MONTHS.

**Thirty-Five Years Ago**

In Gernsback Publications

**HUGO GERNSBACK, Founder**

Modern Electrics .....	1908
Wireless Association of America .....	1908
Electrical Experimenter .....	1913
Radio News .....	1919
Science & Invention .....	1920
Television .....	1927
Radio-Craft .....	1929
Short-Wave Craft .....	1930
Television News .....	1931

Some larger libraries still have copies of **ELECTRICAL EXPERIMENTER** on file for interested readers.

**In November, 1923, Science and Invention (formerly Electrical Experimenter)**

- World's Energy from Atomic Force, Hearing Through the Teeth, (The Osophone) by H. Gernsback.
- Students Learn Code While Asleep, by S. R. Winters.
- Radio in the Open Balloon Race.
- Fight Returns to Argentine by Radio.
- New Loud-Speaker.
- Radiophone on French Trains, by A. N. Mirzaoff.
- Broadcast Relay on 100 Meters, by Howard Allen Duncan.
- Cockaday Four-Circuit Tuner, by Leroy Western.
- Experimental Circuit Panel, by R.D.B. Washburne.
- Good Single Circuit Receiver, by H. Allen Duncan.
- Crystal Detectors, by A. P. Peck.

NOVEMBER, 1957

In Stock . . . at "the place to buy"  
**hallicrafters**  
Only \$31<sup>41</sup>  
PER MO. JUST 10% DOWN  
NET PRICE: \$395.00

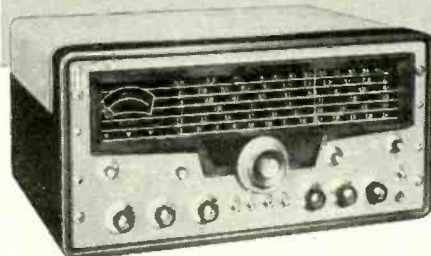

**SX-101**

at **WORLD RADIO**

"The World's Largest Distributor of Amateur Radio Equipment!"

- ✓ Top Trades!
- ✓ Prompt Shipment!
- ✓ Easy Terms!

**FREE 1958 Catalog**

200 pages, hundreds of illustrations, 15,000 top value items write for yours, today!

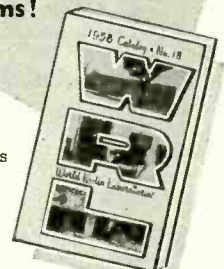

Top flight receiver in the field: seven ham bands, large slide rule dial; 1.8-2.4 mc., 3.2-4.1 mc., 7.0-7.3 mc., 14.0-14.4 mc., 21.0-21.5 mc., 26.95-27.35 mc. and 28.0-29.7 mc., plus special 10 mc. position for WWV. Covers most important MARS frequencies. Dual conversion receiver with exclusive upper/lower side band selection. T-notch filter, 50:1 tuning knob ratio with absolute re-setability, built-in precision 100 kc. marker crystal. Illuminated dual scale S-meter functions with AVC off. Five steps of selectivity from 500-5000 cycles and precision temp. compensation. 52 ohm antenna input. 14 tubes plus voltage regulator and rectifier. Size: 20x10½x16". Shp. wt. 74 lbs.

R-46B Speaker, wt. 13½ lbs. — \$17.95



Please send me Free Catalog . . . and complete info on Hallicrafters SX-101.

NAME: \_\_\_\_\_  
ADDRESS: \_\_\_\_\_  
CITY & STATE: \_\_\_\_\_

"Boy! You aren't kidding. Your husband is a bear if you forget the **JENSEN NEEDLES**."

**COMPUTERS, ROBOTS AUTOMATION**

- TRANSISTOR DIGITAL COMPUTER KIT.** Build the newest circuits. Multi-vibrators, counters, logic circuits, and 'or', 'flip flops and use them. This is the first time we offer this kit after months of testing and preparation. A 'first' on the market for EBE, we thank our engineers. Can be expanded with standard parts to increase range and capacity. For speedy reply order by air mail. Send \$59.50 for kit plus instructions.
- ELEMENTARY RELAY COMPUTERS,** 7 lessons on the principles of operation and programming. No math over simple algebra needed. Complete for \$12.50.
- LOGIC,** learn how to evaluate relay circuits and problems by use of Boolean algebra. Solve games, etc. 10 lessons plus text \$12.50.
- ROBOTS,** manual on construction, building projects. Use standard parts for circuits. Save money by building your own relays and timers. You receive 200 pages and additional data for one year for FREE. \$5.00 ppd.
- ELECTRONICS,** learn the principles of radio, television, radar, test equipment, transistors, computers. 40 lessons plus three text books, \$22.50 down and \$10.00 per month for five months. This is the lowest price for the entire field!
- RELAYS,** build your own, learn how to use, evaluate, choose, buy, switch all types of relays. You will become an expert after reading this manual. Projects for building your own special types! \$2.75 ppd.

**ELECTRONIC BRAIN ENTERPRISES, INC.**  
1015 Atkin Ave., Salt Lake City 6, Utah

Name: \_\_\_\_\_  
Address: \_\_\_\_\_

ask the  
"Man-on-the-Roof"  
why he prefers  
*South River*

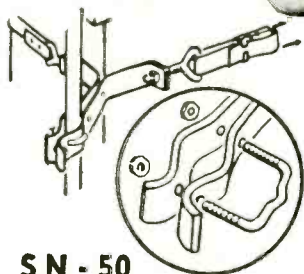

**SN-50  
CHIMNEY MOUNT  
SNAP-IN TYPE**

with unique U-Bolt INSTEAD OF SCREWS for easy one hand "Spintite" fastening. Hot Dip Galvanized — 12 Ft. Straps two to a set. Same Unique U-Bolts used on Snap-in Wall Brackets. Also Available with Stainless Steel Banding.

Write for new 1957 catalog

**SOUTH RIVER**  
METAL PRODUCTS CO., INC.  
South River, New Jersey

pioneer & outstanding producer of finest line of antenna mounts

**SPRAY it or DROP it**



the NEW  
**QUIETROLE  
Spray-Pack**

or the  
**QUIETROLE**  
Bottle with the  
Eye Dropper Cap

Now QUIETROLE offers you both types of containers. Either way assures you of the same unflinching results that QUIETROLE is known for.

Make your next purchase QUIETROLE, get both and learn the difference between quality and poor substitutes. QUIETROLE is the original product of its kind, it is a FIRST of the Industry and you can depend on it to end your noisy control and switch troubles.



manufactured by



**QUIETROLE  
COMPANY**  
Spartanburg, South Carolina

**Yours now—over 150 practical circuits using  
TRANSISTORS!**

Rufus P. Turner, popular transistor authority and engineer, takes transistors out of the laboratory and puts them on the work bench. He has collected over 150 practical circuits for amplifiers, oscillators, power supplies, amateur equipment and other units. All were designed by experts—some by the author himself. All were tested in the author's laboratory—and all of them work! No watering down with transistor testing or theoretical explanation circuits! This book offers a treasure chest of building blocks which will save hours of tiresome designing. You can put these circuits to an infinite number of uses other than those originally suggested. No one who works with transistors at home or in the lab can afford to miss Turner's latest book. Order your copy now.

**SOME OF THE HIGHLIGHTS**

Audio Amplifiers • RF and IF Amplifiers • DC Amplifiers • Oscillators • Power Supplies • Radio Receivers • Triggers and Switches • Control Devices • Test Instruments • Amateur Devices • Miscellaneous Circuits including Geiger counter, phono oscillator, hearing aid, and intercom.

**ORDER THESE COMPANION VOLUMES BY TURNER**

**Transistors—Theory & Practice**—The practical man's "Bible" on transistors. Covers theory, characteristics, tests, plus a guide to commercial transistors. Written so the practical man can read, understand and learn how to work with transistors. No. 51—144 pages. \$2.00

**Transistor Techniques**—A handbook for the experimenter who wants to work with transistors! Gives scores of hints on how to use transistors in various types of equipment. Covers testing, performance, construction, care and measurements. A practical how-to-do-it book which keeps theory and math to a minimum. No. 61—96 pages. \$1.50

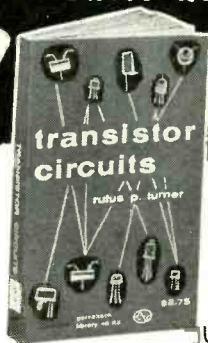

JUST OFF THE PRESS!

**TRANSISTOR CIRCUITS**—By Rufus P. Turner. 160 Pages. Gernsback Library Book No. 63. Paper cover. \$2.75

**MAIL THIS COUPON TODAY**

**GERNSBACK LIBRARY, Inc., Dept. 117**  
154 West 14th St., New York 11, N.Y.

My remittance of \$..... is enclosed. Please send me the books checked below postpaid.

- No. 63 Transistor Circuits. \$2.75
  - No. 61 Transistor Techniques. \$1.50
  - No. 51 Transistors—Theory & Practice \$2.00
- Prices 10% higher in Canada.

NAME..... please print

STREET.....

CITY.....STATE.....

**Books**

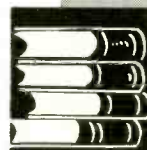

**TRANSISTOR APPLICATIONS, Vol. II.** Raytheon Manufacturing Co., 55 Chapel St., Newton 58, Mass. 58 pages, 8½ x 11 inches. 50c.

This edition covers more general ground than the previous one. It includes hints on lab techniques, shop practice and basic transistor theory. There are construction articles on radio receivers, ham equipment, home broadcasters, burglar and fire alarms. Printed circuits, use of sun batteries and wiring precautions are also discussed. —IQ

**ELECTRONIC ENGINEERING**, By Samuel Seely. McGraw-Hill Book Co., Inc., 330 W. 42 St., New York 36, N. Y. 525 pages 6 x 9. \$8.

This book analyzes basic circuits used in communications, computers and control instruments. Both physical and mathematical explanations are clearly stated, with many examples worked out in the text. Major chapter headings include amplifiers, oscillators, sweep generators, rectifiers, tubes and transistors. Feedback, frequency response and other important topics are adequately covered. An excellent study and reference for designers, engineers and technicians.—

**GETTING STARTED IN AMATEUR RADIO**, by Julius Berens, W2PIK. John F. Rider, Publisher, Inc., 116 W. 14th St., New York 11, N. Y. 5½ x 8½ inches, 136 pages. \$2.40.

Not many years ago, would-be hams had to grope their way to a license for there was little information available unless they knew a friendly licensed amateur. Today, it is possible for one to become an amateur with a reasonable amount of effort. Here is a book that any ham would gladly recommend to beginners. It tells the whole story—how to study the code, how to use a key, elementary radio theory and study questions. The more important FCC regulations are printed at the back of the book.

The book prepares for both novice and general-class licenses. No previous technical knowledge is assumed. —W2OUX

**TRANSISTOR CIRCUIT ENGINEERING**, edited by Richard F. Shea. John Wiley & Sons, Inc., 440 Fourth Ave., New York 16, N. Y. 5¾ x 9 inches, 468 pages. \$12.

This is an advanced transistor book prepared by a staff of G-E engineers. It shows how to design audio and video

BOOKS (Continued)

amplifiers, oscillators and modulators as required. Bias and stabilizing networks receive full attention, and there are many practical examples. Formulas and graphs are often referred to. The final chapters show how these basic circuits are put to work in radio and TV receivers, filters, converters and power supplies.—IQ

**ESSENTIAL CHARACTERISTICS, Tube Sales Section, General Electric Co., Schenectady, N. Y. 5 1/2 x 8 1/2 inches, 228 pages. 75c.**

This spiral loose-leaf manual lists every tube likely to be encountered in radio and TV receivers. It shows the type of service, electrical characteristics and capacitance, besides physical data. Basing connections appear on the same page.

Besides ordinary receiving tubes, the manual lists the special 1600, 5000, 6000 and 9000 series. Prototypes like 5U4-GB, 6AQ5, 6SN7, 12AX7, etc. appear again at the end of the book with average characteristics in graph form. Several circuit diagrams of receivers, amplifiers and power supplies are also included.—IQ

**ELEMENTS OF COLOR IN PROFESSIONAL MOTION PICTURES.** Society of Motion Picture & Television Engineers, 55 W. 42 St., New York 36, N. Y. 6 x 9 inches, 104 pages. \$3.50.

Color photography is a highly spe-

cialized and complex field that embraces both art and science. Thus it often happens that studio artists and technicians know much about their own particular phase, but little of what is going on in other departments. For them, a special committee of the SMPTE has prepared this book. In nonengineering terms it tells how to plan and process color films. Many color photos illustrate the theory of color, several of the more important commercial processes and the results of improper handling. One chapter deals with problems of TV color films and kinescope recordings.

**TRANSISTOR CIRCUITS,** by Rufus P. Turner. Gernsback Library, Inc., 154 W. 14th St., New York 11, N. Y. 5 1/2 x 8 1/2 inches, 160 pages. \$2.75.

A variety of useful, practical and experimental transistor circuits are described here. They are presented in a way that gives maximum benefit and information to those wishing to duplicate the device. Thus each schematic shows all component values. Several amplifiers are accompanied by their frequency response curves. Coil tables give winding data for several oscillators. Surface-barrier transistors and zener diodes are represented in addition to the common p-n-p and n-p-n transistors.

Largest chapters are those devoted to audio amplifiers, radio receivers,

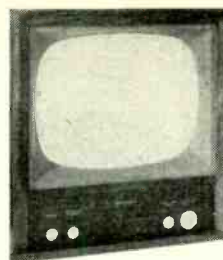

**BUILD YOUR TV CABINET**

Comparable to the type that Top Mfrs. use on their finest TV Sets.

You receive—The **FRONT PANEL ASSEMBLY** complete as pictured in genuine Mahogany, Walnut or Blond Korina in a beautiful hand-rubbed finish with **MASK, SAFETY GLASS.**

You also receive—the **TOP & SIDES** finished in matching color, the perforated **BACK** with **CRT CUP, GLUE, SCREWS, NAILS** and amazing **Easy-To-Follow Instructions.** 90% of the job is done for you. All you add are the **BOTTOM & 1" connecting STRIPS.**

**21" CABINET**  
H-26" W-25" D-22"  
**\$24.95**

**24" or 27" CABINET**  
H-30" W-28 1/2" D-22"  
**\$32.47**

**TV CRYSTAL-CLEAR LUCITE MASKS**

Framed in Rich Goldleaf Finish

Tube Size	Overall Dimensions	Price
17"—Rectangular	13 1/8" x 16 1/2"	\$ 4.56
21"—Rectangular	16 1/2" x 21 1/4"	6.92
24"—Rectangular	20 1/4" x 25 3/4"	11.84
27"—Rectangular	20 1/4" x 26"	12.18

On 17" and 21" specify type number of CRT used

**TV PLASTIC OPEN MASKS**

Used in conjunction with safety glass

17"—Rectangular	15 3/4" x 18 1/2"	\$1.49
21"—Rectangular	18" x 22 1/2"	2.38
24"—Rectangular	21" x 26"	4.93
27"—Rectangular	21" x 26"	4.93

On 17" and 21" specify type number of CRT used

**TV SAFETY GLASS IN HANDY SIZES**

16" x 20"	\$2.94	18" x 22 1/2"	\$5.16
16" x 22"	3.97	21" x 26"	5.87

**BROOKS RADIO & TV CORP.**  
84 Vesey St., New York 7, N. Y.

**SPECIAL! for Schools, TV Technicians & Customers in South America & Canada**

*Excitingly new!* **DX-16 Super Deluxe TV KIT**  
70° or 90° — operating all 21", 24" and 27" PICTURE TUBES.

The **DX-16 SUPER DELUXE TV KIT** is a worthy successor to the famous #630 TV KIT . . . a product in which we took a leading role. In designing and engineering this **NEW KIT**, we used the #630 as a standard of comparison for **POWER, STABILITY and FRINGE AREA RECEPTION** . . . resulting in a **NEW TV CHASSIS equal in performance and with even greater versatility.**

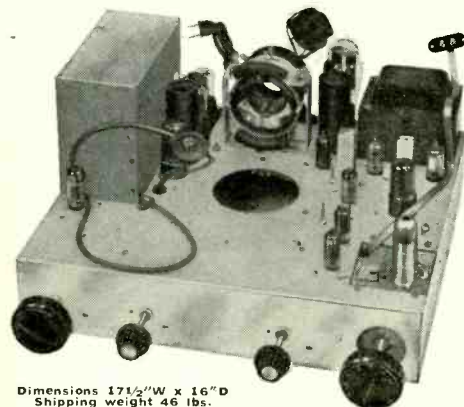

Dimensions 17 1/2" W x 16" D  
Shipping weight 46 lbs.

**NEW IN DESIGN — Mounts Horizontally, Vertically or Sideways.**

- ★ Large 250 ma Power Transformer — not a hot chassis.
- ★ Produces a Superior 16-Tube Chassis with 30-Tube performance.
- ★ Latest advanced Intercarrier Circuitry and Multi-section Tubes.
- ★ Standard Cascode Tuner for Selectivity and Fine Definition.
- ★ 5 Microvolts Video Sensitivity (20 volts peak to peak at CRT grid).
- ★ Fast Action AGC for Drift Free, Steady and Clear Pictures.
- ★ 3 Hi-gain Video I.F. Stages for excellent Contrast and Details.
- ★ AGC Level and Area Control, for adjusting reception to signal area.
- ★ All Video and I.F. Coils factory pre-aligned and tuned.
- ★ Horizontal Sweep Circuit is the famous RCA Synchroguide Network.
- ★ Large 12" Concert-tone Speaker.

ALL COMPLETE with <b>LIFE-SIZE</b> step-by-step Building Instructions (less tubes & CRT) . . . . .	<b>\$69.97</b>
ALL COMPLETE with SET of <b>WESTINGHOUSE TUBES</b> (less CRT) . . . . .	<b>\$79.97</b>
ALL COMPLETE with SET of <b>WESTINGHOUSE TUBES</b> and <b>WESTINGHOUSE 21" 70° or 90° Aluminized CRT</b> . . . . .	<b>\$99.97</b>

You may purchase the **LIFE-SIZE** step-by-step Instructions before purchasing KIT. Send \$2.49 which you can deduct on purchase of KIT, or return for cash refund.

**BROOKS RADIO & TV CORP., 84 Vesey St., New York 7, N.Y.** TELEPHONE  
CORtland 7-2359

**SURPLUS RADIO CONVERSION MANUALS**

Data found in these books has become standard for most commonly used items of surplus electronic equipment.

**VOLUME I:** Freq. Meter — BC-342 Rcvr. — BC-348 Rcvr. — BC-312 Rcvr. — BC-412 Oscilloscope as a test scope or as a TV Rcvr. — BC-645.420 Mc. Xmitter/Rcvr. — BC-453A Series Rcvrs. — BC-457A Series Xmitters — SCR-522 144 Mc. Xmitter/Rcvr. — TBY Transceiver with Xtol Control — PE-103A Dynamotor — BC-1068A V-h-f Rcvr. — Electronics Surplus Index — Cross Index of VT-No. tubes.

**VOLUME II:** ARC-5 and BC-454 Rcvrs. for 28 Mc. — ARC-5 and BC-457 Tx for 28 Mc. Mobile — ART-13 and ATC Xmitter — Surplus Beam Rotating Mechanisms — Selenium-Rect. Power Units — Hi-Fi Tuner from BC-946B Rcvr. — ARC-5 V-h-f Xmitters — GO-9 and TBW Xmitters — 9-W Amplifier from AM-26 — TA-12B and TA-12C Xmitters — AVT-112A Aircraft Xmitter — BC-375 and BC-191 Xmitters — Model LM Freq. Meter — Primary Power Requirements Chart — ARB Rcvr. (Diagram Only)

**\$2.50 per volume**  
\*Plus any tax.

**WORLD'S MOST COMPLETE VACUUM TUBE DATA —**

**Characteristics and Comparisons**  
**WORLD'S RADIO TUBES**

Radio Tubes Vade Mecum  
Characteristics of all tubes from all countries. World's largest list of tube data. Listed numerically and alphabetically. Base connection section. **\$5.00**

**WORLD'S EQUIVALENT TUBES**

Equivalent Tubes Vade Mecum  
All replacement tubes for a given type, both exact and near-equivalents (with points of difference detailed). Military tubes and commercial equivalents. Over 43,900 comparisons. **\$5.00**

**WORLD'S TELEVISION TUBES**

Television Tubes Vade Mecum  
Characteristics of all TV picture, C.R., and special purpose tubes. A "must" for all specialists. **\$5.00**

**BUY FROM YOUR FAVORITE DISTRIBUTOR**  
at above price or add 10% on direct mail orders to:  
**EDITORS and ENGINEERS, Ltd.**  
SUMMERLAND 3, CALIFORNIA  
BOOKSTORES: ORDER FROM BAKER & TAYLOR CO., HILLSIDE, N.J.

BOOKS (Continued)

control devices and test instruments. Here one will find data to assemble complementary and direct-coupled amplifiers, superhets, relays, alarms, signal injectors, dip oscillators, light meters and many others. Among other chapter headings are amateur devices, rf amplifiers and power supplies. This book is a saver of time and energy for all who work (or play) with transistors.

**TRANSISTOR MANUAL**, second edition. Semiconductor Products Dept., General Electric Co., 1224 W. Genesee St., Syracuse, N. Y. 5½ x 8½ inches, 112 pages. 50c.

Having exhausted its first edition, this handy manual goes into the second. It meets the needs of technicians and hobbyists who wish to keep up with latest developments in transistors for radio, test equipment and gadgets. Complete specifications of nearly 50 G-E transistors are given. It also contains diagrams of many amplifiers, portable radios and hi-fi circuits. A table lists all Jetec transistor types with characteristics.

The manual begins with the theory of semiconductors and circuits. It shows how to bias properly, provide stabilization and couple multiple stages. Tone controls, preamplifiers, reflex if stages, converters and switches are drawn. Of course, the new Unijunction is described and many uses appear. Pulse circuits are also given considerable attention.

**TV TROUBLE TRACER**, Vol. 6. Harry G. Cisin, Amagansett, N. Y. 5½ x 8½ inches, 45 pages. 50c.

The sixth volume of this popular handbook can save hours of time and labor. It covers many portable TV sets of all manufacturers. Detailed drawings show the tube layouts of the various sets. Each tube is also marked with a code letter; for example, a vertical output tube is marked with a V for vertical. Forty common difficulties are illustrated by a test pattern showing the fault. A discussion of various faults that may be at the seat of the trouble is also given. Added help is given by indicating sets with selenium rectifiers and series circuits. Also contains tube locations of the most recent 1957 RCA TV sets, portables and standard models.—LS **END**

**CORRECTION**

The Patents column on page 140 of the September issue contains a queer typographical error which transposes complete sentences from two different items. The last sentence in the second paragraph of the item "Volume Control Circuit" was transposed with the last sentence of the first paragraph of the item "Transistor Power from Local Radiation."

We thank Robert Sparkes, of Toronto, Ont., for this correction.

**CATALOG OF Professional Quality Kits**  
"DIRECT FROM FACTORY"

**FREE**

**TRANSVISION SPLIT/KITS**

- TV KITS
- INSTRUMENT KITS
- HI-FI KITS, SPEAKERS
- HI-FI CABINETS (Largest Selection)
- Electronic PHOTOFLASH Kits

PAY AS YOU WIRE with Transvision "SPLIT-KITS." A few dollars gets you started. Each Kit is split into a few packages. You can order one at a time as you wire.

**Also RECORDS at BIGGEST DISCOUNT!**  
RCA - CBS All Labels

TRANSVISION, INC., New Rochelle, N. Y.  
Rush FREE Catalog of KITS, HI-FI Equipment, Cabinets, Records, etc

Name \_\_\_\_\_  
Address \_\_\_\_\_  
City \_\_\_\_\_ State \_\_\_\_\_

**LEARN**

**Television**  
RADIO-COLOR-TV  
**Electricity**  
ELECTRONICS

IN THE GREAT SHOPS OF **COYNE**

**TRAIN QUICKLY! OLDEST, BEST EQUIPPED SCHOOL of ITS KIND in U.S.**

**Veterans and Non-Veterans**—Get practical training in top opportunity fields. Prepare now for a better job and a real future. Advanced education or previous experience not needed. Employment service to graduates.

**Enroll NOW—Pay Later**  
Finance Plan and Easy Payment Plan. Also Part Time Employment help for students. Training in Refrigeration and Electric Appliances can be included.

**FREE BOOK** Clip coupon for Big Free Illustrated Book. No obligation and No Salesman Will Call. Act NOW.

**B. W. COOKE, Jr., President**  
**COYNE**  
ELECTRICAL SCHOOL  
OPERATED NOT FOR PROFIT  
Established 1899  
500 S. Paulina, Chicago  
Dept. 87-81H

**B. W. COOKE, Jr., Pres.**  
**COYNE Electrical School**  
500 S. Paulina St., Chicago 12, Ill. Dept. 87-81H

Send FREE BOOK and full details on:

TELEVISION-RADIO  
 ELECTRICITY-ELECTRONICS

NAME \_\_\_\_\_  
ADDRESS \_\_\_\_\_  
CITY \_\_\_\_\_ STATE \_\_\_\_\_



# SCHOOL DIRECTORY

Interesting, Pictorial  
**FREE BOOKLET**

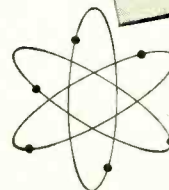
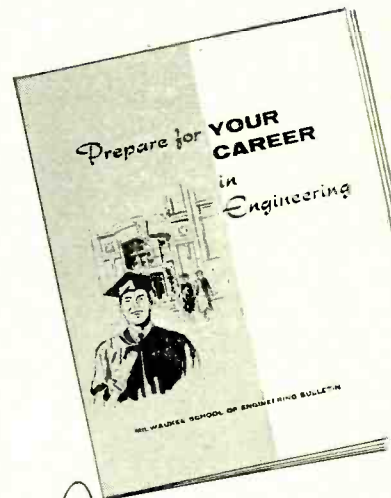

to help  
you  
decide on

**YOUR CAREER  
IN ELECTRONICS  
RADIO-TV  
COMPUTERS**

Here is a graphic story about dynamic careers for engineers and engineering technicians. Booklet covers such subjects as:

- Wide variety of job opportunities.
- The courses offered, degrees you can earn, and what you are qualified to do.
- Pictures of the Milwaukee School of Engineering, its facilities, plus Milwaukee scenes.
- Recreation, student organizations, fraternities.
- Scholarships, part-time work, admission requirements.

— and many other important and interesting facts to help you understand and decide on your career in engineering. Send for your *free* copy today — no obligation whatsoever.

MS-62

**Milwaukee School of Engineering**  
—dedicated to serving young men and industry

**SEND COUPON**

**Milwaukee School of Engineering**

Dept. RE1157, 1025 N. Milwaukee St.  
Milwaukee, Wisconsin

Please send me free the new booklet  
"Prepare for Your Career in Engineering"  
I'm interested in \_\_\_\_\_  
(name of course)

Name \_\_\_\_\_ Age \_\_\_\_\_

Address \_\_\_\_\_

City \_\_\_\_\_ Zone \_\_\_\_\_ State \_\_\_\_\_

I'm eligible for veteran's education benefit

Yes  No  Discharge date \_\_\_\_\_

**ENGINEERING DEGREES**  
UNDER AND POSTGRADUATE  
E.E.  
Option Electronics

Earned through  
**HOME STUDY**  
Residence Classes Also Available

**PACIFIC INTERNATIONAL UNIVERSITY**  
5719-M, Santa Monica Blvd.,  
Hollywood 38, Calif.

**ELECTRONICS**

**PREPARE FOR A GOOD JOB!**  
**BROADCAST ENGINEER**  
**RADIO SERVICING AUTOMATION**

**TELEVISION SERVICING**  
**BLACK & WHITE—COLOR**

APPROVED FOR VETERANS AND SURVIVORS  
OF VETERANS  
BUILDING AIR CONDITIONED  
SEND FOR FREE LITERATURE

**BALTIMORE TECHNICAL INSTITUTE**  
1425 EUTAW PLACE, BALTIMORE 17, MD.

**CODE SENDING**  
**RECEIVING SPEED**

Be a "key" man. Learn how to send and receive messages in International Morse code. Communicate with operators around the globe. Learn at home quickly through famous Candler System. Used by best operators. Qualify for Amateur or Commercial License. Write for **FREE BOOK**.

**CANDLER SYSTEM CO.**  
Dept. 3-M, Box 928, Denver 1, Colo., U.S.A.

**Radio experts solve your engineering problems**  
Save \$8.50 on newly revised  
**RADIO ENGINEERING LIBRARY**

**ELECTRONICS ENGINEERING DEGREE IN 27 MONTHS**

Prepare for unlimited opportunities in electronics!

B.S. degree in 27 months, mathematics, electrical engineering, TV, advanced radio theory and design. Modern labs. Low tuition, earn board. Also Aero., Chemical, Civil, Electrical, Mech., Engineering. B.S. degree in 36 mo. in Math., Chem., Physics. Also prep courses. G.I. appr. 20 bldgs., dorms, gym. Enter Dec., March, June, Sept. Catalog. Keeping Pace With Progress.

**INDIANA TECHNICAL COLLEGE**  
1511 E. Washington Blvd., Fort Wayne 2, Ind.

At your fingertips in one convenient source—facts, standards, practices, data for the whole field of radio engineering. Highlights current developments in transistors, other semi-conductors, microwave tubes, pulse techniques, color TV, and more. Covers everything from tube and circuit fundamentals through essentials of major fields of application.

**OVER 4000 PAGES OF PRACTICAL MATERIAL!**

Five fact-packed volumes of data, graphs, charts and tables give information quickly. Includes material on UHF, frequency modulation, instruments and methods for measuring high frequency, etc. Selected by radio specialists as most helpful material for engineers, designers, and others in communication, broadcasting, aircraft radio, and related fields, this Library is yours at a special price on easy terms.

**Pay as you use on EASY TERMS**

3rd Ed.—Fundamentals of Vacuum Tubes (Eastman); 3rd Ed.—Electronic & Radio Eng'g. (Terman); 2nd Ed.—Communication Eng'g. (Everitt); 2nd Ed.—High Freq. Measurements (Hund); 4th Ed.—Radio Eng'g. Handbk. (Henry).

**10-DAY FREE TRIAL**

McGraw-Hill Book Co., Dept. RE-11  
327 W. 41 St., New York 36, N. Y.

Send for 10 days' FREE trial, the Radio Engineering Library. In 10 days I will send (check one)  
 \$49.50; or  \$7.50 in 10 days and \$7.00 a month until \$49.50 is paid—a savings of \$8.50 over regular price of \$58. Otherwise I will return books postpaid.

Name .....

Home Address.....

City & State.....

Employed by.....

For price and terms outside USA, RE-11 write McGraw-Hill Int'l., N.Y.C.

**TOP-FLIGHT ELECTRONICS**

Train for technical representative, field engineer, electronic specialist on missiles, computers, radar, automation, radio, color-TV. Basic and advanced theory and laboratory. Mathematics. Major firms select our graduates. Dormitories-campus. 21 months' program. High school graduate or equivalent. G.I. approved. Start February and September.

Write for illustrated catalog today.

**VALPARAISO TECHNICAL INSTITUTE**  
Dept. C Valparaiso, Indiana

**college grads get ahead faster!**

... have higher incomes ... advance more rapidly. Grasp your chance for a better life. Share rewards awaiting college men. Important firms visit campus regularly to employ Tri-State College graduates. Start any quarter. Approved for Vets.

**Bach. Sc. degree in 27 months**

Complete Radio Eng. courses (TV, UHF, FM, Electronics). Also Mech., Civil, Elec., Chem., Aero., Eng. 36-months in Bus. Adm. (Gen. Bus., Acctg., Motor Transport Mgt.). Superior students faster. More professional class hours. Small classes. Enrollment limited to 1550. Beautiful campus. Well-equipped labs. Prep courses. Enter Jan., Mar., June, Sept. Earnest, capable students (whose time and budget require accelerated courses and modest costs) are invited to write Jean McCarthy, Dir. Adm., for Catalog and "Your Career in Engineering and Commerce."

**TRI-STATE COLLEGE**  
24117 College Ave., Angola, Indiana



*Dave Rice's*  
**OFFICIAL**  
**ORDER BOOK**  
for every TV-Radio  
service call



Triplicate forms serve as order form, invoice and office record with spaces for complete information on every job. Separate listings for receiving tubes, pix tube, parts, serial numbers, labor and tax charges, signatures, etc. 75c a book, \$6.50 for dust-proof box of 10.

... and for customer's prices on every replacement part, Dave Rice's

**OFFICIAL PRICING DIGEST**  
listing over 60,000 items. \$2.50

In stock at your distributor, or write

**ELECTRONIC PUBLISHING CO. INC.**  
180 North Wacker Drive Chicago 6, Illinois

SAVE 1/2 — PAY PART-BY-PART — HAVE FUN  
**Assembling the SCHOBER**  
**ELECTRONIC**  
**ORGAN** in KIT form



**NO SPECIAL SKILLS NEEDED**

Now you can afford a real, full concert organ, just like those made by the foremost organ manufacturers. Because over 1/2 the cost is saved when you assemble it yourself. And it's REALLY EASY: only 24 separate units, all with printed circuits, and detailed-to-the-smallest-step instructions. In addition, you purchase each of the 24 kits when you are ready for it — and can afford it.

You'll get a real kick out of putting the Schober Electronic Organ\* together — and then sitting down and pulling the stops for Strings, Trumpets, Clarinets, Diapasons, Flutes, etc. Electronic Percussion optional; chimes available.

**Compact CONSOLE**

One of the many exclusive features of this exceptional organ is the handsome console, in a wide variety of finishes. It is equally at home in a traditional or modern setting, and takes little more space than a spinet piano.

**Free Literature**

Complete descriptive booklet and price list are available on request. And, if you wish to hear the glorious pipe organ tone of the Schober Electronic Organ, a 10" long-playing demonstration recording is available for \$2. This is refundable when you order. Write today and see what a fine instrument you can get at such a great saving.

**The SCHOBER ORGAN CORP.**

2248-B Broadway, New York 24, N. Y.

\*Designed by Richard H. Dorf

Moss Electronics Distributing Co.	80-81
National Radio Institute	3, 19-20
National Schools	5
North American Philips Co., Inc.	94, 140
Oelrich Publications	134
Opportunity Adlets	146-147
ORRadio Industries, Inc.	95
PACO Electronics Co., Inc.	82
Perma-Power Co.	136
Phaotron Instrument & Electronic Co.	116
Philco Accessory Division	99, 127
Pickering & Co., Inc.	79
Precision Electronics, Inc.	150
Prentice-Hall, Inc.	156
Progressive "Edu-Kits" Inc.	115
Quality Electronics	162
Quam-Nichols Company	147
Quietrol Co., Inc.	158
Radiart Corp.	26
RCA Electron Tube Division	Back Cover
RCA Institutes	17
RCA (Test Equipment)	166
Radio-Television Training Association	15
Raytheon Manufacturing Co.	24
Rek-O-Kut Co., Inc.	12
Rider (John F.) Inc.	142
Rinehart & Co., Inc.	126, 151
Rohn Manufacturing Co.	23
Sams (Howard W.) & Co.	22, 83, 144
Schober Organ Co.	163
Scott (Herman Homer)	21
Seco Manufacturing Co.	154
Service Instruments Co.	148, 162
Shure Brothers, Inc.	108
South River Metal Products	158
Sprayberry Academy of Radio	27
Stan-Burn Radio & Electronics	152
Stanley Electronics Corp.	138
Superex Electronics	155
Techmaster Corp.	152
Teletest Inc.	137
Terado Co.	136
Thorens Co.	14
Transvision Inc.	160
Triad Transformer Co.	155
Trio Manufacturing Co.	119
Tung-Sol Electric Co.	6
Uncle Sam Recording	151
University Loudspeakers, Inc.	105
Utah Radio Products Corp.	156
Weller Electric Corp.	124
Western Radio	137
Winegard Co.	112
World Radio Labs.	157
Wuerth Tube-Saver Corp.	134

**SCHOOL DIRECTORY PAGE 161**

Baltimore Technical Institute  
Candler System Co.  
Indiana Technical College  
Milwaukee School of Engineering  
Pacific International University  
Tri-State College  
Valparaiso Technical Institute

**BRANCH ADVERTISING OFFICES:** Chicago: 1413 Howard St. Tel. ROgers Park 4-8000. Los Angeles: Ralph W. Harker and Associates, 600 South New Hampshire. Tel. DUnkirk 7-2328. San Francisco: Ralph W. Harker and Associates, 444 Market St. Tel. GARfield 1-2481.

**FOREIGN AGENTS:** Great Britain: Atlas Publishing and Distributing Co., Ltd., 18 Bride Lane, London E.C. 4. Australia: McGill's Agency, Melbourne. France: Brenano's, Paris 2e. Belgium: Agence et Messageries de la Presse, Brussels. Holland: Trilectron, Heemstede. Greece: International Book & News Agency, Athens. So. Africa: Central News Agency, Ltd., Johannesburg. Capetown, Durban, Natal: Universal Book Agency, Johannesburg. India: Broadway News Centre, Dadar, Bombay #14. Pakistan: Paradise Book Stall, Karachi 3.

**CRYSTAL CONTROLLED CONVERTERS**  
**POLICE • FIRE • COMMERCIAL**



- ✓ Precision—Stability
  - ✓ Sensitivity
  - ✓ Easy Installation
- \$32.50**

• A compact converter supplied with commercial tolerance crystals, self contained automatic noise limiter. Also models with squeelch. Ideal for mobile or home use.

**TUNERS**

Enjoy FM Programs While You Drive.

- FM BROADCAST
- 30-50 MC
- 108-176 MC

from \$22.50



WRITE FOR LITERATURE

**KUHN ELECTRONICS**  
20 GLENWOOD CINCINNATI 17, OHIO

Significantly  
**BETTER**



**ULTRA-LINEAR II\***  
*Amplifier*

Significantly better—of course—because it features a new feedback system in the proven Acro-Developed, Ultra-Linear circuit that sets a new standard of stability in amplifier performance.

Significantly better—the heart of the 60 watt Ultra-Linear II amplifier is the Acrosound TO-600 output transformer which provides a degree of feedback unaffected by the impedance of the speaker system.

Significantly better—the Ultra-Linear II amplifier is supplied in kit form with all critical wiring preassembled on a rugged printed circuit board... simple construction requires only 2 hours' assembly time.

**Significantly better in every way:**

- RATED POWER OUTPUT**—60 watts
- IM DISTORTION**—less than 1% at 60 watts
- HARMONIC DISTORTION**—Less than 1% between 20 CPS and 20 KC at power output within 1 DB of 60 watts
- SENSITIVITY**—1.8 volts RMS for 60 watts output
- OUTPUT IMPEDANCE**—4, 8, 16 ohms
- TUBES**—2-EL34/6CA7, 1-GZ34, 1-12AX7, 1-12AU7
- DAMPING FACTOR**—Variable 0.5 to 10.
- HUM**—90 DB below rated output
- SIZE**—7" x 15" x 8" high.
- WEIGHT**—30 lbs.
- Price \$79.50 complete with all components. \$109.50 wired and assembled (slightly higher in West)

\* Patent Pending

Available at leading distributors

Please send literature on illustrated Ultra-Linear II Amplifier

Name .....

Address .....

City ..... State .....

**ACRO PRODUCTS COMPANY**  
369 SHURS LANE, PHILADELPHIA 28, PA.

# Exclusive Lafayette Money-Saving Values



**PK-300**  
ILLUMINATED  
BUILT-IN  
STROBOSCOPE &  
VIEWER

**COMBINATION  
DEAL**

**PK-300 TURNTABLE  
PK-90 TONE ARM  
G.E. CARTRIDGE  
with GENUINE  
DIAMOND & SAPPHIRE  
STYL! Model 46-052**

**72.50**

## LATEST IMPROVED MODEL PK-300 PROFESSIONAL TRANSCRIPTION TURNTABLE

New 3-speed instrument with built-in stroboscope and viewer for exact speed determination, and magnetic brake for instantaneous speed variation. Precision engineered to meet professional standards for wow, rumble and flutter content. Heavy 12" cast aluminum rim-driven turntable. Variable speed control permits adjustment of each speed within  $\pm 7\%$  using efficient frictionless magnetic brake. Heavy-duty constant speed 4-pole induction motor freely suspended and isolated by shock-mountings to eliminate vibration transference. R-C filter network suppresses "pop" in speaker. Truly a delight for the connoisseur. Size:  $13\frac{1}{2} \times 14$ " and requires  $2\frac{3}{4}$ " clearance above and  $3\frac{3}{4}$ " below motorboard. For 110-130V and 60/50 cycle AC. Power consumption 12 watts. Handsome hammertone gray finish. Shpg. wt., 20 lbs.

PK-300 ..... Net **49.50**



**PK-90**

LICENSED UNDER CBS  
U. S. PATENT NO. 2676806



**PK-170**

LICENSED UNDER CBS  
U. S. PATENT NO. 2676806

## PK-90 VISCOUS-DAMPED TONE ARM

This transcription arm assures dependable and stable operation, utilizing the "floating action" principle of "viscous-damping." The arm is supported at a single point by a pivot and jewel bearing having negligible friction. Damping is accomplished by a silicone fluid occupying the gap between a ball and socket. This damping control permits high compliance and negligible tracking error, and prevents damage to either record or stylus should the tone arm be accidentally dropped. Low frequency resonance, skidding and groove-jumping are likewise minimized. The tone arm accepts all records up to 16" and accommodates virtually all hi-fi cartridges by means of precisely engineered adapters which simplify installation and provide proper stylus pressure.

This tone arm is a quality companion to the PK-300 with matching finish. Shpg. wt., 2 1/2 lbs.

PK-90—12" Transcription Tone Arm ..... Net **11.95**

## 16" VISCOUS DAMPED TRANSCRIPTION TONE ARM

A 16" viscous damped arm at an unbelievable low price. An exclusive sealed unit eliminates possibility of silicone leakage. Features single point pivot mounting, precision pickup arm adjustment controls, and plug-in adapters for all popular cartridges. Shpg. wt., 3 1/2 lbs.

PK-170—16" Transcription Tone Arm ..... Net **17.95**



**SK-67**      **SK-74**



**HW-7**



**HK-3**



**LN-3**

## 3 WAY SYSTEM WITH 15" WOOFER . . . 8" MID-RANGE SPEAKER . . . HORN TWEETER . . . CROSSOVER NETWORK

- 15-INCH WOOFER WITH 31.5 OZ. MAGNETIC (SK-67)
- 8-INCH MID-RANGE SPEAKER (SK-74)
- NEW HIGH FREQUENCY ACOUSTICAL LENS TWEETER (HW-7)
- 3-WAY CROSSOVER NETWORK (LN-3)

Lafayette presents this outstanding 3-way speaker system designed for the high fidelity enthusiast who desires performance formerly possible in multi-speaker systems costing many times this price. You won't believe your ears when you hear the superb reproduction throughout the entire audio spectrum. The SK-67 15" woofer provides phenomenal bass response, the SK-74 8" speaker delivers full bodied, mid-range frequencies, and the HW-7 high frequency acoustical lens tweeter faithfully reproduces the highest audible frequencies. Crossover points at 350 and 5000 cycles are provided by the LN-3 3-way inductance-capacitance network with continuously variable presence and brilliance controls that adjust tone balance to personal taste. Shpg. wt., 25 lbs.

SY-93. Complete System as listed above ..... Net **55.50**

## 2 WAY SPEAKER SYSTEM 40-16,000 CYCLES

- 25 WATT WOOFER
- CROSSOVER NETWORK
- IMPORTED HI-FI TWEETER
- LEVEL BRILLIANCE CONTROL

This 2-way speaker system is another excellent buy for the moderate purse. It is basically the same as the SY-85 system described at the top of the page, but incorporates the deluxe SK-68 speaker with 21.5 oz. Alnico V magnet. This results in more efficient reproduction and extension of the lower register. Complete system includes the SK-68 12" 25 watt woofer, HK-3 cone type tweeter and LN-2 crossover network with level-brilliance control. Range of system 35-16,000 cycles. Shpg. wt., 18 lbs.

SY-87—Complete System ..... Net **27.50**



**6 TRANSISTOR  
SUPERHET RECEIVER KIT**

- 100% SUBMINIATURIZED
- SENSITIVE, SELECTIVE, STABLE
- PUSH-PULL OUTPUT
- PLENTY OF POWER
- AN INCOMPARABLE VALUE

The Lafayette KT-119 6 Transistor Superhet Receiver Kit provides superior commercial quality with maximum sensitivity, selectivity and stability. The circuit features 6 selected transistors and crystal diode, a specially matched set of 3 IF's, Oscillator coil, high Q loop, and audio transformer coupling. Has efficient 2 1/4" speaker and earphone jack for private listening. Complete with all parts, transistors, pre-punched chassis and easy to follow step-by-step instructions.  $6\frac{1}{2} \times 3\frac{1}{2} \times 1\frac{1}{2}$ ". Shpg. wt., 3 lbs.

KT-119—Complete Kit—Less Case & Battery ..... Net **29.95**  
BATTERY RCA VS300 ..... Net **1.23**    BURGESS P6 ..... Net **.77**  
MS-339—Sturdy, attractive brown leather case with carrying strap for KT-119. Shpg. wt., 1 lb. .... Net **2.95**  
MS-366—Sensitive matching earphone Net **1.29**



**NEW POCKET AC-DC VOM MULTITESTER**

2,000 ohm per volt sensitivity on both DC and AC

160 ua 3" METER 1% PRECISION RESISTORS  
SILVER CONTACT SELECTOR SWITCH  
FULL SCALE RANGES

D.C. Volts: 0-10; 0-50; 0-500; 0-1000 Volts—A.C. Volts: 0-10; 0-50; 0-500; 0-1000 volts—D.C. Current: 500 ua and 500 ma—Resistance: 0-10K; 0-1 Meg—Decibels: -20 to +22; +20 to 36 db (0 db=0.775 V)—Capacity: 250 mmdf. to .2 mfd—.005 mfd to 1 mfd—Output Ranges: 0-10; 0-50; 0-500; 0-1000 volts.

Best Buy in America! A very accurate and sensitive VOM. This Multitester is a complete instrument (not a kit) with high quality and sensitive 160 microamp meter; 2000 ohm per volt on both AC and DC. Single selector switch, 1% precision resistors, 3" meter. Features extreme versatility, accuracy and ruggedness. In attractive plastic front panel; with metal bottom for ruggedness and shielding. First capacity range requires 50 volt AC source. Second capacity range requires 10 volt AC source. Size  $4\frac{1}{4} \times 3\frac{1}{2} \times 1\frac{1}{2}$ ". Complete with test leads and batteries. Shipping weight 4 lbs.

RW-27A ..... Complete **8.95**



**3 TRANSISTOR SUPERHET  
POCKET RADIO KIT**

- A TRUE POCKET SUPERHET RECEIVER
- NO EXTERNAL ANTENNA
- NO EXTERNAL GROUND

A remarkable sensitive, super-selective pocket superhet receiver with astonishing performance over the complete broadcast band. Uses 2 high-frequency and one audio transistor plus efficient diode detector and features 2 specially matched IF transformers for maximum power transfer. The components are housed in a professional looking beige plastic case. The receiver's appearance enhanced by attractive maroon and silver station dial. Sensitive built-in ferrite antenna eliminates need for external antenna. A designer's dream in a true pocket superhet receiver! Complete with all parts, transistors battery, case, dial and easy to follow step-by-step instructions.  $1\frac{1}{2} \times 2\frac{1}{2} \times 1-1/16$ ". Shpg. wt., 1 lb.

KT-116—Complete Kit, less earphone ..... Net **16.95**  
MS-260—Super Power Dynamic Earphone ..... Net **3.95**



**HIGH SENSITIVITY 20,000 OHM  
PER VOLT DC 10,000 OHM  
PER VOLT AC MULTITESTER**

LOOK AT THESE FULL SCALE RANGES!

D.C. Volts: 0-6; 0-30; 0-120; 0-600; 0-1200; 0-6000 Volts—A.C. Volts: 0-6; 0-30; 0-120; 0-600; 0-1200 Volts—Resistance: 0-10K; 0-100K; 0-1 Meg; 0-10 Megohms—D.C. Current: 0.60 Microamp; 0-6; 0-60; 0-600 Milliamperes—Decibel: -20 to +17 db (0db=0.774V)—Capacity: .0001-.01; .005-.15 mfd—Inductance: 20-2000 millihenry—Output Ranges: 0-6; 0-30; 0-120; 0-600; 0-1200 Volts.

The new Lafayette high sensitivity Multitester is a complete instrument (not a kit). In addition to its unusual sensitivity of 20,000 OHMS PER VOLT ON D.C. AND 10,000 OHMS PER VOLT ON A.C., and the extraordinary number and scope of its ranges, it is packed with features that would make it cost at least twice as much if made in this country. Uses 1% precision resistors, silver contacts on selector switch, 35 ua 3" meter. Dependable, rugged and accurate. Even the test leads are heavy duty with high voltage insulation. Voltage source required for low capacity range is 120V for high range capacity and inductance scale is 6V A.C. Attractive plastic front with metal bottom. Size  $6\frac{1}{4} \times 4\frac{1}{4} \times 2\frac{1}{4}$ ". Complete with batteries and leads. Shipping weight 4 1/2 lbs.

RW-30A ..... Singly, Each **19.95**  
..... in lots of 3, Each **19.25**

**Lafayette Radio**      165-08 Liberty Ave.      100 SIXTH AVE., NEW YORK, N. Y.      JK-1  
JAMAICA 33; N. Y.      BOSTON, MASS., 110 Federal St.      PLAINFIELD, N. J., 139 West 2nd St.  
NEWARK, N. J., 24 Central Ave.      BRONX, N. Y., 542 E. Fordham Rd.

**FREE!**  
**LAFAYETTE**  
**CATALOG**

JUST  
OFF  
THE  
PRESS!



**NEW 180 PAGE ELECTRONIC  
CATALOG FEATURING  
THE BEST BUYS IN THE BUSINESS**

The newest and largest assortment of Electronic, Radio and TV parts, Hi-Fi and Public Address Components and systems, Test Equipment, tubes, Transistor Kits and miniaturized components for transistor circuitry, Ham Equipment, Builders Kits, Tools, Books, Microscopes, Binoculars, Telescopes, Cameras, and Drafting Equipment.—ALL AT LOWEST PRICES—Catering to the economy minded dealer, serviceman, engineer, technician, experimenter and hobbyist. **CRAMMED FULL OF MONEY SAVING BUYS. SEND FOR YOUR FREE COPY TODAY.**

*Lafayette*

**Introduces Hi-Fi Gems**  
... at prices everyone can afford

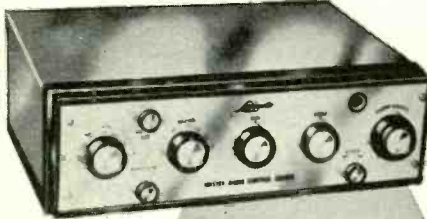

KT-300  
IN KIT  
FORM  
**39.50**



KT-400  
IN KIT  
FORM  
**69.50**



LA-22  
WIRED  
12 WATT  
AMPLIFIER  
**33.50**  
WITH  
CASE

**NEW! MATCHED TUNER AND AMPLIFIER**



LT-25  
WIRED  
FM-AM  
TUNER  
**49.50**  
WITH  
CASE

**LAFAYETTE MASTER AUDIO CONTROL CENTER**

with **BINAURAL CHANNEL AND DUAL VOLUME CONTROL.**  
*Years Ahead of Every Other Control Unit ... Ahead In Sound ... Ahead In Styling Ahead In Design ... Ahead In Features ... Available In Kit and Wired Form*

This is not only the finest hi-fi preamp characterized by unmatched features, but it has been functionally designed to keep pace with the conversion of your present hi-fi system to binaural (Stereophonic) sound. Incorporates an extra channel and dual volume control for binaural reproduction. Features include DC on all tube filaments, negative feedback in every stage, dual cathode follower output stages and latest printed circuit construction. Less than 0.09% IM distortion and less than 0.07 harmonic distortion at 1V. Hum and noise level better than 80 db below 3V. Uniformly flat frequency response over entire audible spectrum. 7 inputs for every type of phono, tuner or tape. Tasteful styling, brilliantly executed. Size 12 3/4 x 9 1/4 x 3 3/4". Shpg. wt., 10 1/2 lbs.

KT-300—Lafayette Master Audio Control Kit Complete with cage and detailed assembly instructions. Net **39.50**

LT-30—Same as above completely wired and tested with cage and instruction manual. Net **59.50**

**DELUXE 70 WATT BASIC AMPLIFIER**

- Conservatively Rated At 70 Watts • Ultra-Stable • Variable Damping
- Metered Balance And Bias Adjust Controls • Available In Kit And Wired Form

Here's ultra-stability in a 70 watt basic power amplifier employing highest quality components conservatively rated to insure performance and long life. Features matched pair KT 88's and wide range linear output transformer, variable damping control, meter for bias and balance and chrome plated chassis. Frequency response 10-100,000 cps ± 1db. Hum and noise 90db below full output. IM distortion less than 1 1/2% at 70 watts, less than 0.3% below 30 watts. Harmonic distortion less than 2% at 70 watts from 20 to 20,000 cps ± 1db. Output impedance 4,8 and 16 ohms. Handsome decorative cage perforated for proper ventilation. Size 14 1/2 x 10 x 7 3/4" including cage and knobs. Shpg. wt., 40 lbs.

KT-400—Lafayette 70 watt Deluxe Basic Amplifier Kit complete with cage and detailed assembly instructions. Net **69.50**

LA-70—Same as above completely wired and tested with cage and instruction manual. Net **94.50**

**LAFAYETTE 12 WATT AMPLIFIER WITH CASE**

Complete 12 Watt Power Amplifier with Built-In Preamplifier-Equalizer  
Brings Real Hi-Fi at Low Cost

The Lafayette LA-22 amplifier features wide range frequency response and low hum and distortion. Utilizes premium quality EL84 tubes in a pentode connected balanced output circuit. Five inputs provided for every type of phono cartridge, tuner, tape head, TV, crystal phono, etc. Function selector and equalization switch give instant choice of proper equalization for all types of records and tape head. Loudness control approximates Fletcher-Munson characteristics for tonal balance at low listening levels. Bass and treble controls afford wide variation of cut or boost of highs and lows. Frequency response 30-20,000 cps ± 1 db. Sensitivity, for full output 1/2 V on tuner, crystal or aux., 8 mv for magnetic phono or tape head. I.M. Distortion less than 1 1/2%. Attractively finished to harmonize with both modern and traditional decor, its appearance matches the Lafayette LT-25 tuner. Size 13 3/8" x 6 3/8" x 4 1/2". Shpg. wt., 15 lbs.

LA-22 Amplifier, Complete With Removable Case. Net **33.50**

**LAFAYETTE HI-FI FM-AM TUNER WITH CASE**

- Armstrong Circuit With Limiter • Foster-Seeley Discriminator
- Temperature Compensation and AFC • Custom Styled

Like its matching amplifier, the Lafayette LT-25 FM-AM tuner is a most unusual value with outstanding specifications and superlative performance. Circuit features temperature compensation for stability and low drift, AFC to "lock-in" the station and AFC defeat for precision tuning of weak stations. Inertia flywheel makes tuning smooth. High selectivity and sensitivity. Meets FCC requirements for radiation. Distortion less than 1% on FM and AM. Frequency Response 20-20,000 cps ± 1 db on FM; 20-5000 cps ± 3 db on AM. Hum level 60 db below 100% modulation. Attractively finished to match the LA-22 amplifier. Comes complete with removable cover, with provisions for mounting either in cabinet or on panel. Size 13 1/2" x 8-3/16" x 4 1/2". Shpg. wt., 15 lbs.

LT-25 FM-AM Tuner, Complete With Case. Net **49.50**

**NEW "DYNA-SLIM" MICROPHONE**

- HIGH IMPEDANCE — 50,000 OHMS
- ON-OFF SWITCH
- "QUICK-SLIP" ADAPTER

New dynamic, high output microphone with all the features of "mikes" costing 3 times Lafayette's price! Output level —55db. Smooth response from 60 to 10,000 cycles. Omnidirectional head. External on-off switch. Slips on or off stand adapter in a wink. Standard 5/8" — 27 adapter permits tilting mike for multi-angle use. Satin black and chrome finish. Complete with detachable cable and connector. 8" long, 1 1/4" max. dia. tapered panel. Shpg. wt., 2 lbs.

PA-43 Net **6.95**

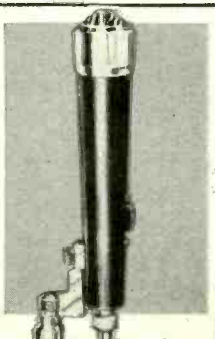

*Lafayette*  
*Radio*

DEPT JK-2

165-08 LIBERTY AVE  
JAMAICA 33, N. Y.

NAME \_\_\_\_\_

ADDRESS \_\_\_\_\_

CITY \_\_\_\_\_ ZONE \_\_\_\_\_

STATE \_\_\_\_\_

**SEND  
FREE  
CATALOG  
305**

**CUT OUT AND MAIL TODAY!**

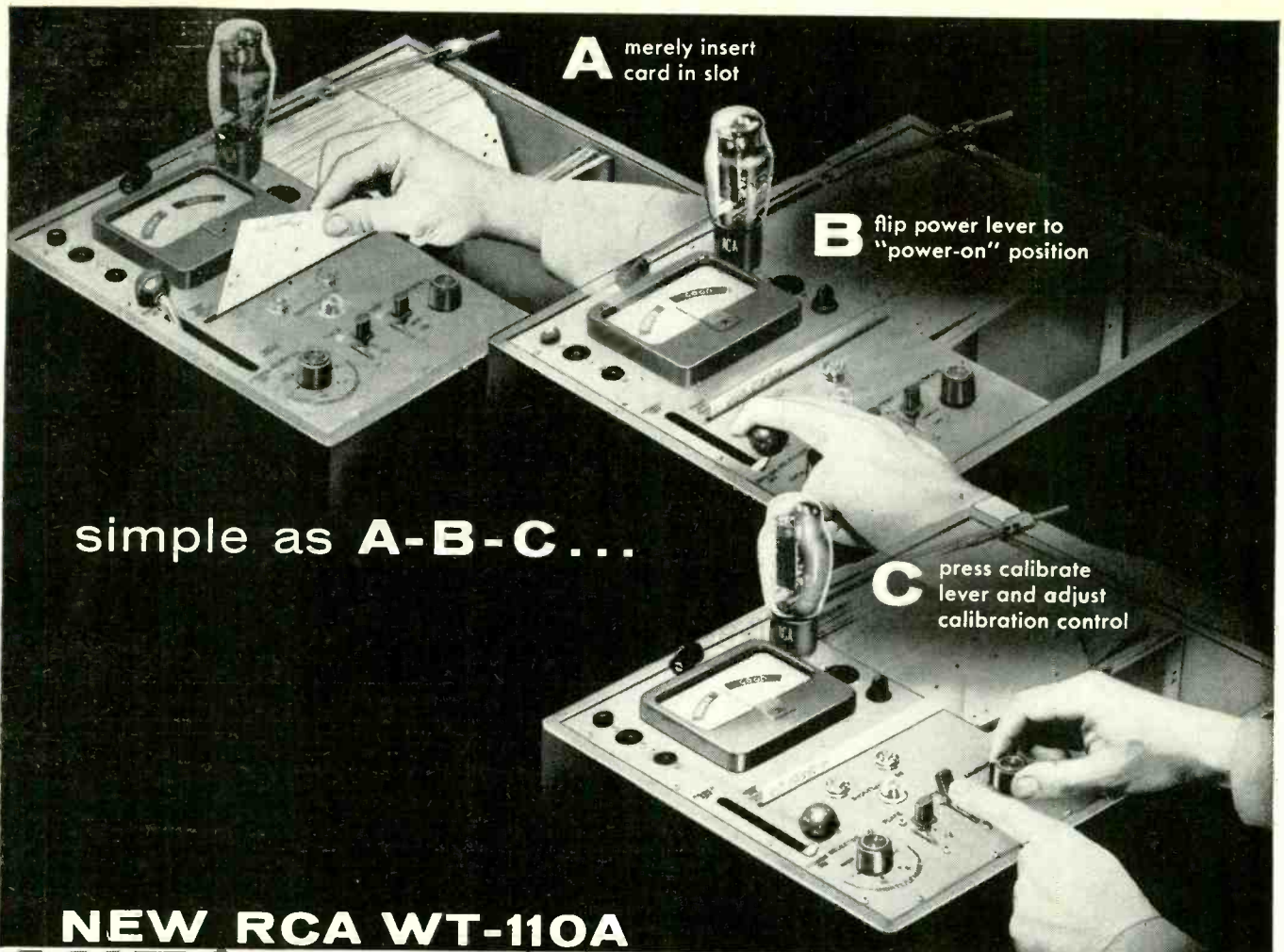

**A** merely insert card in slot

**B** flip power lever to "power-on" position

**C** press calibrate lever and adjust calibration control

simple as **A-B-C...**

# NEW RCA WT-110A AUTOMATIC TUBE-TESTER

means more service profits!

Dollar for dollar, feature for feature, you'll find RCA's WT-110A the fastest, most accurate automatic punched-card tester you can buy today. It's a virtually *obsolescence-proof design* ... from the exclusive RCA 700-card capacity magazine file that always keeps the pre-punched cards in type number sequence, to the fully automatic circuit setup (including *all* operating voltages) and the easy, do-it-yourself punch card accessories available to keep the tube-card file up-to-date!

See and test the WT-110A at your local RCA Distributor. Prove to yourself what a boost in business, prestige, profits the RCA-WT-110A can mean!



**TEST EQUIPMENT**  
**RADIO CORPORATION OF AMERICA**

Electron Tube Division, Harrison, N. J.



All this for  
**\$199.50**

USER PRICE (Optional)  
Prices higher in Hawaii and Alaska

- automatically sets up socket connections, and all operating voltages such as heater, signal, plate and screen voltages, and bias (both fixed and cathode).
- checks tubes for transconductance, gas, shorts, and leakage between elements.
- automatically selects correct conditions from 220 possible combinations of heater voltage (from 0.1 volt to 120 volts) at currents up to 4 amps., 10 bias voltages and 11 values of cathode resistors.
- tubes, such as rectifiers, tested under heavy load currents up to 140 ma per plate.
- high-and-low sensitivity ranges for leakage tests.
- 12-volt plate and screen supply for testing new out-radio tubes.
- meter protected against burnout.
- test card provided for checking instrument.
- 239 pre-punched cards supplied with instrument cover 95% of currently active TV tubes. Pre-punched accessory cards available.
- active card magazine capacity—350; storage capacity—350...a total capacity of 700 cards.

# FOR HI-FI ON A BUDGET, FOLLOW THE ELECTRO-VOICE BUILDING BLOCK PLAN

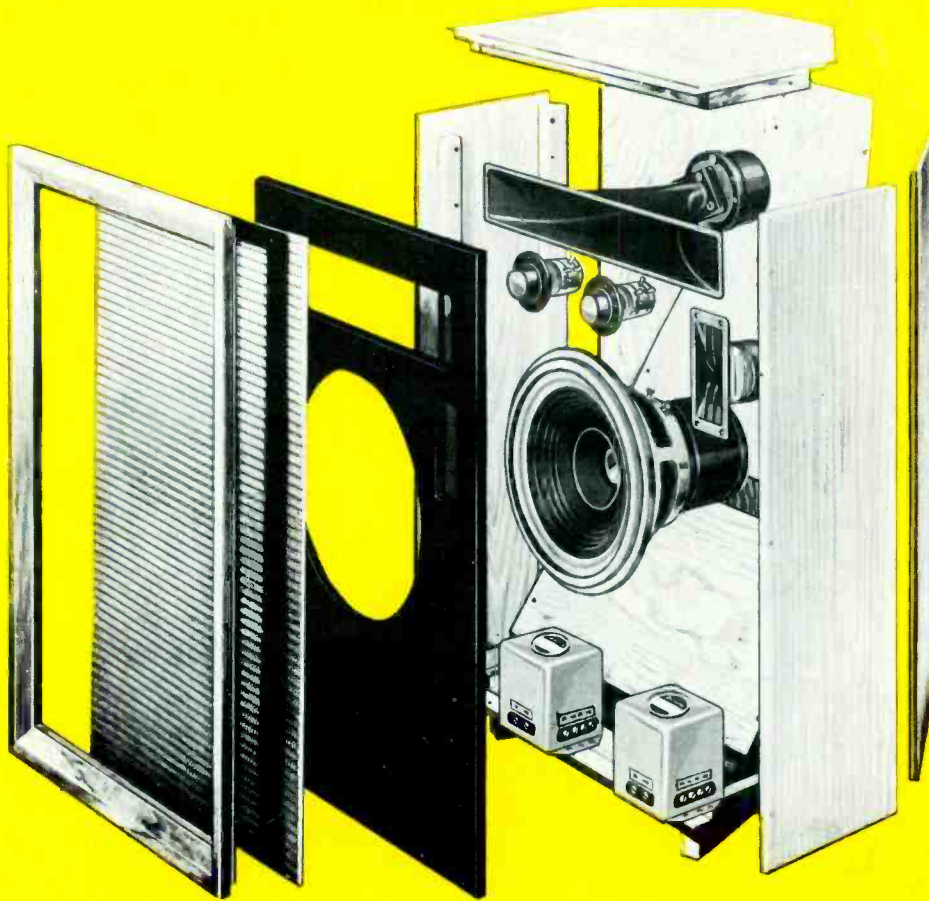

Start with your basic speaker and improve your compatible E-V high-fidelity system one economical step at a time by adding Electro-Voice Speaker Building Blocks.

Here, we've started with an SP12—12-inch coaxial driver. Later, you add BB2—a T35 very-high-fre-

quency driver, X36 crossover and AT37 level control with wiring harness. BB2, Net \$50. Still later, augment with the BB4—to smooth and disperse treble range, it includes T25A treble driver, with 8HD horn, a second crossover—800-cps X8—and a second AT37 level control with wiring harness. BB4, Net \$114.

## Build Your Own E-V Speaker Enclosure with a Pre-Cut, Pre-Cleated 'Do-It-Yourself' Kit

There's no thrill like building your own speaker enclosure! Economize on your hi-fi system without sacrificing quality by assembling an E-V knock down kit of Korina plywood. Korina is of highest quality, naturally light in color, harder than mahogany, allows finishing to match any shade. There are seven models to choose from.

**Shown dis-assembled is E-V's KD6 kit.** Assemble it and you have a duplicate of our factory-built ARISTOCRAT enclosure of folded horn corner design for use with 12-inch drivers or separate multi-way systems. KD6, Net \$39.

*For all the facts about Electro-Voice 'Listeneered' high-fidelity components, see your distributor and write for complete details.*

# Electro-Voice®

ELECTRO-VOICE, INC. BUCHANAN, MICHIGAN

Export: 13 East 40th Street, New York 16, U.S.A. Cables: ARLAB

[www.americanradiohistory.com](http://www.americanradiohistory.com)

**QUIET**

**Trouble-  
shooter  
at  
work**

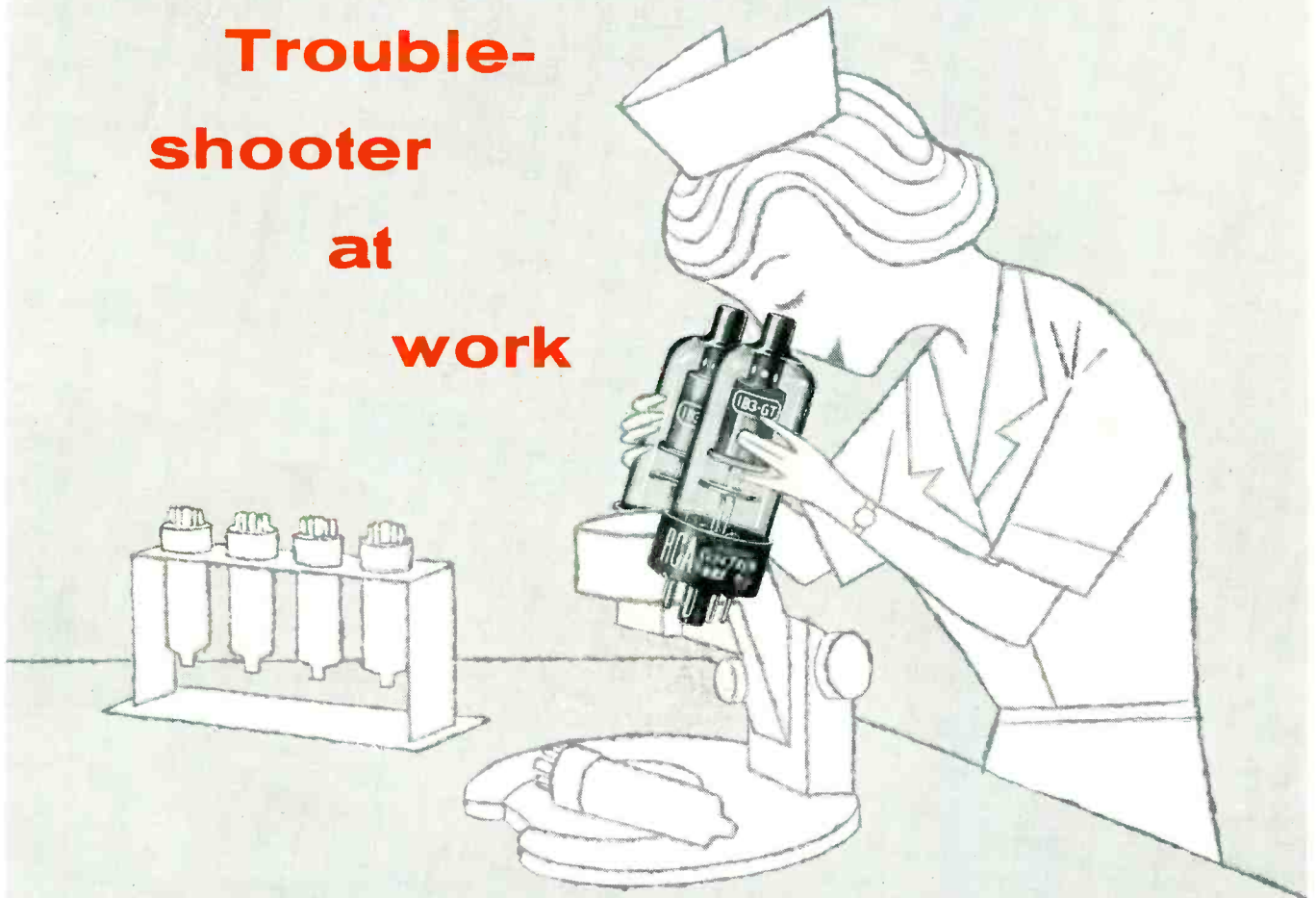

**Here's how Microscopic Inspection by RCA helps reduce costly callbacks...**

A bad tube, or a potential trouble-maker—can it get by this gal? Not likely. She's part of the specially trained RCA group of inspectors whose important job it is to find trouble and help prevent it from happening *to you*.

RCA Quality-Control Procedures include MICROSCOPIC INSPECTION OF POPULAR TV RECEIVING TYPES! These types are closely examined for possible poor welds, weld splatter, bad crimps, damaged stems, improper assembly, and many other factors that can affect top quality, long-term performance. Though the tubes may pass all electrical tests, such defects could slip by and mean the difference between a profitable service call and a costly callback.

You gain valuable assurances from this *extra* care: (1) that popular TV receiving types shipped to RCA Tube Distributors have had the *extra* benefit of the MICROSCOPIC INSPECTION PROGRAM and (2) that you can always service your customers with the confidence that RCA TV Receiving Types are top quality replacement tubes.

When you order—tell your distributor "RCA only" and watch your profits grow.



**RECEIVING TUBES**

**RADIO CORPORATION OF AMERICA**

Tube Division, Harrison, N. J.

